

JVC



English

中文

HOME CINEMA CONTROL CENTER

家庭播放中央控制系统

RX-F31S

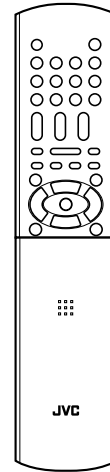
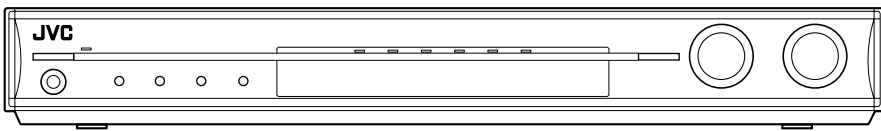

AV COMPU LINK

INSTRUCTIONS

使用说明书

Warnings, Cautions, and Others / 警告, 注意及其他须知事项

Caution—/I STANDBY/ON button!

Disconnect the mains plug to shut the power off completely. The /I STANDBY/ON button in any position does not disconnect the mains line. The power can be remote controlled.

注意—/I STANDBY/ON 开关!

想要完全关闭电源，须将电源插头从插座上拔下。无论 /I STANDBY/ON 键处于何种位置，主电路仍旧没有关闭。电源开关可用遥控器进行控制。

CAUTION

To reduce the risk of electrical shocks, fire, etc.:

1. Do not remove screws, covers or cabinet.
2. Do not expose this appliance to rain or moisture.

注意

为了减少触电，火灾等危险：

1. 请勿擅自卸下螺丝钉，盖子或机壳。
2. 请勿让本机受雨淋或置潮湿环境中。

CAUTION

- Do not block the ventilation openings or holes. (If the ventilation openings or holes are blocked by a newspaper or cloth, etc., the heat may not be able to get out.)
- Do not place any naked flame sources, such as lighted candles, on the apparatus.
- When discarding batteries, environmental problems must be considered and local rules or laws governing the disposal of these batteries must be followed strictly.
- Do not expose this apparatus to rain, moisture, dripping or splashing and that no objects filled with liquids such as vases, shall be placed on the apparatus.

注意

- 切勿堵塞通风眼或孔。
(如果通风眼或孔被报纸或布等物堵塞，热量将无法散出。)
- 切勿在机体上放置任何裸露的火源，如点燃的蜡烛。
- 想要丢弃电池时，必须考虑环保问题以及严格遵守当地关于处理废旧电池的有关法律规定或条例。
- 切勿让本机受雨淋，受潮湿，落上或溅上水滴；亦勿在机体的上面放置盛满液体的容器，如花瓶。

Caution: Proper Ventilation

To avoid risk of electric shock and fire and to protect from damage. Locate the apparatus as follows:

- Front: No obstructions open spacing.
Sides: No obstructions in 10 cm from the sides.
Back: No obstructions in 15 cm from the back.
Bottom: No obstructions, place on the level surface.

In addition, maintain the best possible air circulation as illustrated.

注意：正确的通风方法

为了防止触电、火灾以及避免损坏，按如下要求放置机器：

- 前面：留下空间不要放置障碍物。
侧面：侧面的10 cm之内不要放置障碍物。
背面：背面的15 cm之内不要放置障碍物。
底部：不要放置障碍物，水平放置。

此外、如图所示，尽可能保持最佳的空气循环。

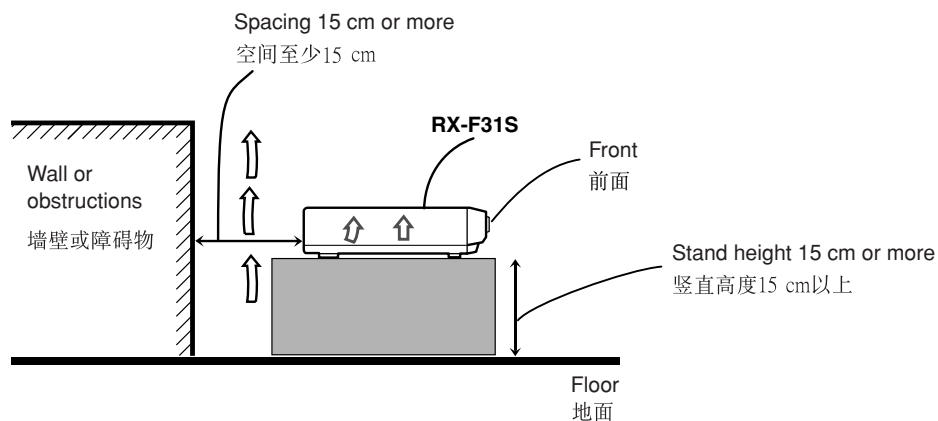
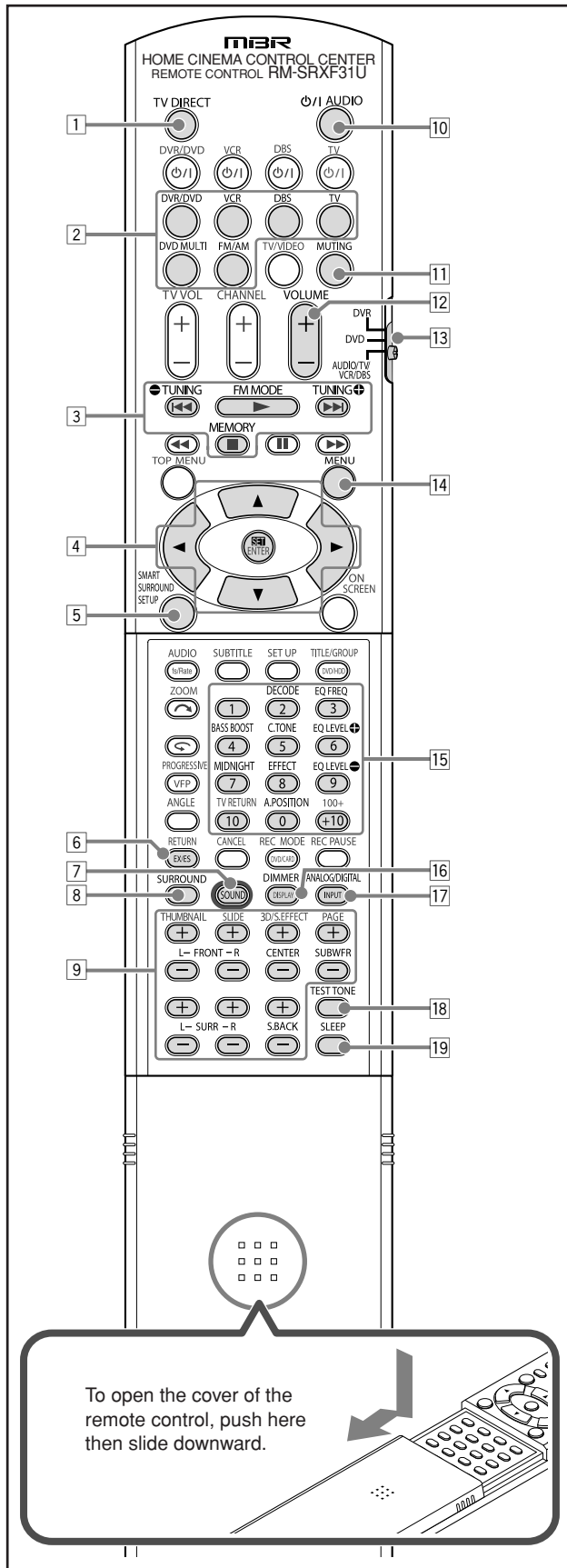

Table of Contents

Parts identification	2
Getting started	4
Before Installation	4
Checking the supplied accessories	4
Putting batteries in the remote control	4
Setting the voltage selector	4
Connecting the FM and AM antennas	5
Connecting the speakers	6
Connecting video components	7
Connecting the power cord	11
Basic operations	12
1 Turn on the power	12
2 Select the source to play	12
3 Adjust the volume	13
Selecting the digital decode mode	13
Adjusting the subwoofer audio position	14
Activating TV Direct	14
Turning off the sounds temporarily	15
Changing the display brightness	15
Turning off the power with the Sleep Timer	15
Basic settings	16
Setting the speaker information automatically	
—Smart Surround Setup	16
Basic setting items	18
Operation through on-screen display menus	18
Menu operation buttons	18
Setup menu configuration	19
Menu operating procedure	20
Setting the items	21
Setting the speakers	21
Activating the EX/ES/PLIIX setting—EX/ES/PLIIX	22
Selecting the main or sub channel—DUAL MONO	23
Setting bass sound	23
Using the Midnight mode—MIDNIGHT MODE	24
Setting the digital input (DIGITAL IN) terminals	
—DIGITAL IN 1/2/3	24
Selecting the component video input mode	
—DVD VIDEO INPUT/VCR VIDEO INPUT	25
Superimposing the menus—SUPERIMPOSE	25
Converting S-video signals into composite video signals	
—DOWN MIX	25
Converting composite video signals into S-video signals	
—Y/C SEPARATE	25
Sound adjustments	26
Basic adjustment items	26
Operation through on-screen display menus	26
Menu operation buttons	26
Setup menu configuration	27
Menu operating procedure	28
Adjusting the items	29
Adjusting speaker output level	29
Adjusting the equalization patterns	
—DIGITAL EQ 63Hz/250Hz/1kHz/4kHz/16kHz	30
Adjusting the bass sounds	30
Adjusting the sound parameters for the	
Surround/DSP modes	31
Tuner operations	32
Setting the AM tuner interval spacing	32
Tuning in to stations manually	32
Using preset tuning	32
Selecting the FM reception mode	33
Creating realistic sound fields	34
Reproducing theater ambience	34
Introducing the Surround modes	34
Introducing the DSP modes	37
Using the Surround/DSP modes	38
Activating the Surround/DSP modes	39
AV COMPU LINK remote control system	40
Operating other JVC products	42
Operating other manufacturers' products	44
Troubleshooting	47
Specifications	48

Parts identification



Remote control

See pages in parentheses for details.

- 1 TV DIRECT button (14)
- 2 Source selecting buttons (12, 14, 32, 33)
DVR/DVD, VCR, DBS, TV, DVD MULTI, FM/AM
- 3 Operating buttons for tuner (32, 33)
TUNING, FM MODE, TUNING, MEMORY
- 4 On-screen display operation buttons (18, 26)
Cursor buttons (▶, ◀, ▲, ▼), **OSD**
- 5 SMART SURROUND SETUP button (16)
- 6 EX/ES button (22)
- 7 SOUND button (13, 14, 22, 24, 30, 31)
- 8 SURROUND button (39)
- 9 Adjusting buttons for speaker and subwoofer output levels (29)
FRONT L +/-, FRONT R +/-, CENTER +/-, SUBWFR +/-,
SURR L +/-, SURR R +/-, S.BACK +/-
- 10 AUDIO button (12, 14)
- 11 MUTING button (15)
- 12 VOLUME +/- button (13)
- 13 Mode selector (12, 14, 16, 18, 22, 24, 26, 29 – 32, 39)
DVR, DVD, AUDIO/TV/VCR/DBS
- 14 MENU button (18, 26)
- 15 • Numeric buttons (33)
• Adjusting buttons (13, 14, 24, 30, 31)
DECODE, EQ FREQ, BASS BOOST, C.TONE,
EQ LEVEL, MIDNIGHT, EFFECT, EQ LEVEL, A.POSITION
- 16 DIMMER button (15)
- 17 ANALOG/DIGITAL INPUT button (12)
- 18 TEST TONE button (17, 29)
- 19 SLEEP button (15)

The buttons which are not indicated here can be used for operating other JVC products or other manufacturers' products. For details, see pages 42 to 46.

- When operating this receiver, set the mode selector (13) to "AUDIO/TV/VCR/DBS."
- When operating a JVC DVD recorder, set the mode selector (13) to "DVR."
- When operating a JVC DVD player, set the mode selector (13) to "DVD."

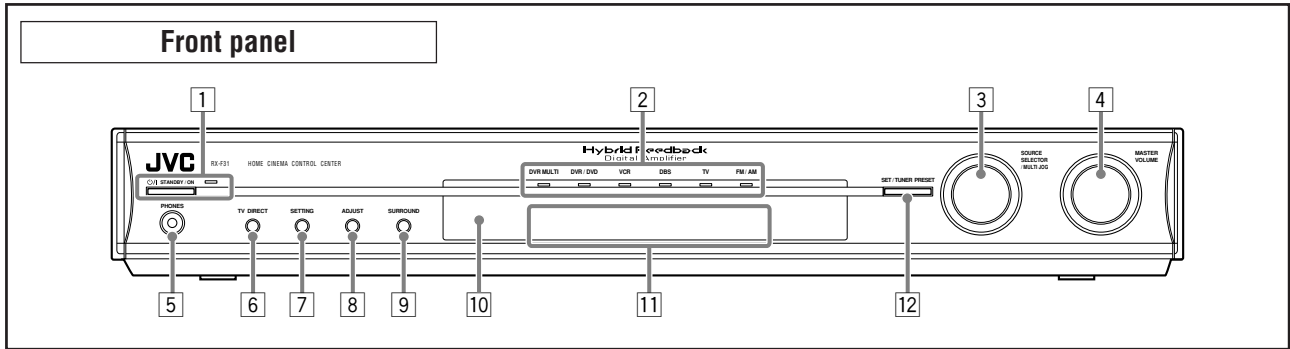

- | | |
|---|---|
| <ul style="list-style-type: none"> 1 ⏻/I STANDBY/ON button and standby lamp (12, 14, 32) 2 Source lamps
DVD MULTI, DVR/DVD, VCR, DBS, TV, FM/AM 3 • SOURCE SELECTOR (12, 14, 33)
• MULTI JOG (18, 26, 33, 39) 4 MASTER VOLUME control (13) 5 PHONES jack (13) 6 TV DIRECT button (14) | <ul style="list-style-type: none"> 7 SETTING button (18, 32) 8 ADJUST button (26, 32) 9 SURROUND button (39) 10 Remote sensor (4) 11 Display window (see below) 12 • SET button (17, 18, 26)
• TUNER PRESET button (33) |
|---|---|

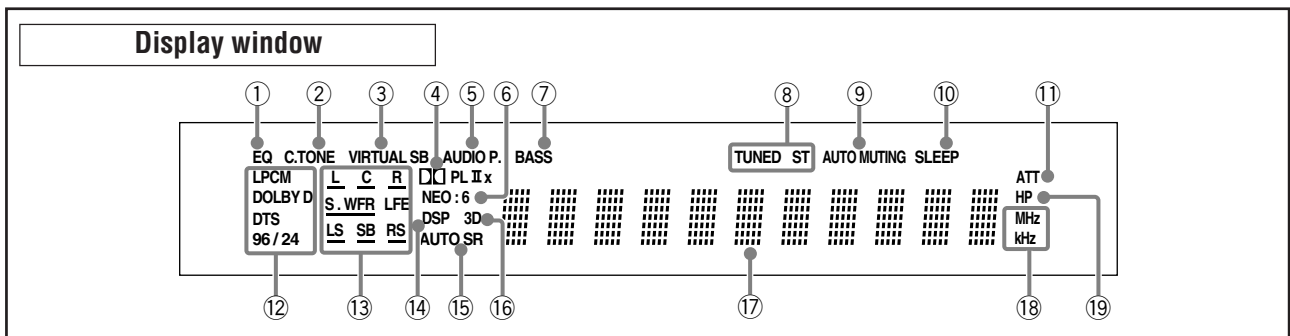

- | | |
|--|---|
| <ul style="list-style-type: none"> 1 EQ indicator (30) 2 C.TONE indicator (31) 3 VIRTUAL SB indicator (38) 4 $\square\square$ PL II and $\square\square$ PL IIx indicator (35) 5 AUDIO P. (position) indicator (14) 6 Neo:6 indicator (36) 7 BASS indicator (30) 8 Tuner operation indicators (32)
TUNED, ST (stereo) 9 AUTO MUTING indicator (33) 10 SLEEP indicator (15) | <ul style="list-style-type: none"> 11 ATT (attenuator) indicator (30) 12 Digital signal format indicators (13, 34 – 36)
LPCM (Linear PCM), DOLBY D (Dolby Digital), DTS, 96/24 13 Signal and speaker indicators (15) 14 DSP indicator (36, 37) 15 AUTO SR (surround) indicator (39) 16 3D indicator (36, 37) 17 Main display 18 Frequency unit indicators
MHz (for FM station), kHz (for AM station) 19 HP (headphones) indicator (13, 36, 37) |
|--|---|

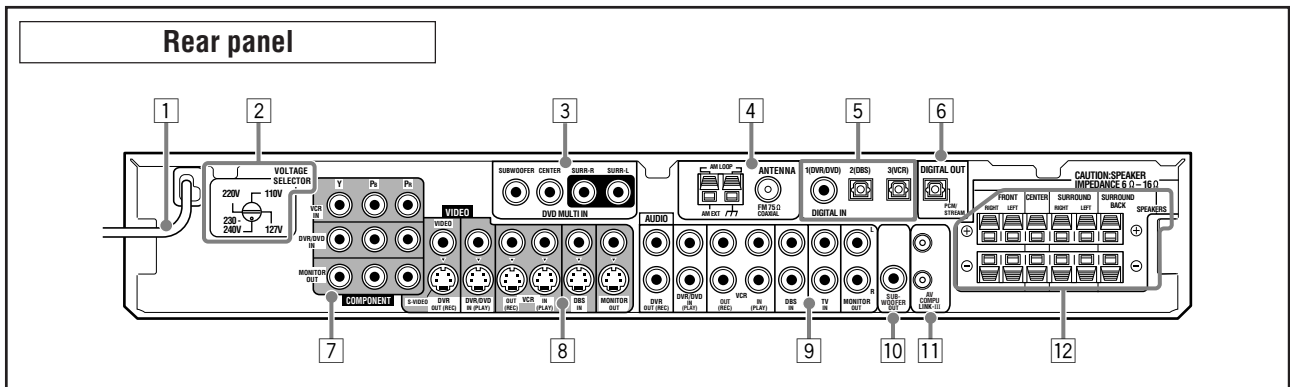

- | | |
|--|--|
| <ul style="list-style-type: none"> 1 Power cord (11) 2 VOLTAGE SELECTOR (4) 3 DVD MULTI IN jacks (8)
SUBWOOFER, CENTER, SURR-R, SURR-L 4 ANTENNA terminals (5) 5 DIGITAL IN terminals (11)
• Coaxial: 1(DVR/DVD)
• Optical: 2(DBS), 3(VCR) 6 DIGITAL OUT terminal (11) 7 COMPONENT (Y, Pb, Pr) jacks (7 – 10)
VCR IN, DVR/DVD IN, MONITOR OUT | <ul style="list-style-type: none"> 8 VIDEO terminals (7 – 10)
VIDEO (composite video) jacks, S-VIDEO terminals
• Input: DVR/DVD IN (PLAY), VCR IN (PLAY), DBS IN
• Output: DVR OUT (REC), VCR OUT (REC), MONITOR OUT 9 AUDIO jacks (7 – 10)
• Input: DVR/DVD IN (PLAY), VCR IN (PLAY), DBS IN, TV IN
• Output: DVR OUT (REC), VCR OUT (REC), MONITOR OUT 10 SUBWOOFER OUT jack (6) 11 AV COMPU LINK-III terminals (40) 12 SPEAKERS terminals (6)
FRONT, CENTER, SURROUND, SURROUND BACK |
|--|--|

Getting started

Before Installation

General precautions

- Be sure your hands are dry.
- Turn the power off to all components.
- Read the manuals supplied with the components you are going to connect.

Locations

- Install the receiver in a location that is level and protected from moisture and dust.
- The temperature around the receiver must be between -5°C and 35°C .
- Make sure there is good ventilation around the receiver. Poor ventilation could cause overheating and damage the receiver.
- Leave sufficient distance between the receiver and the TV.

Handling the receiver

- Do not insert any metal object into the receiver.
- Do not disassemble the receiver or remove screws, covers, or cabinet.
- Do not expose the receiver to rain or moisture.
- Do not pull on the power cord to unplug the cord. When unplugging the cord, always grasp the plug so as not to damage the cord.
- When you are away on travel or otherwise for an extended period or time, remove the plug from the wall outlet. A small amount of power is always consumed while the power cord is connected to the wall outlet.

The receiver has a built-in cooling fan which operates while the receiver is turned on. Be sure to leave enough ventilation to obtain sufficient cooling effect.

CAUTION:

Do not connect the AC power plug to the wall outlet until all connections are completed.

Checking the supplied accessories

Check to be sure you have all of the following supplied accessories. If anything is missing, contact your dealer immediately.

- Remote control (× 1)
- Batteries (× 2)
- AM loop antenna (× 1)
- FM antenna (× 1)
- Digital coaxial cable (× 1)
- AC plug adaptor (× 1)

Putting batteries in the remote control

Before using the remote control, put two supplied batteries first.

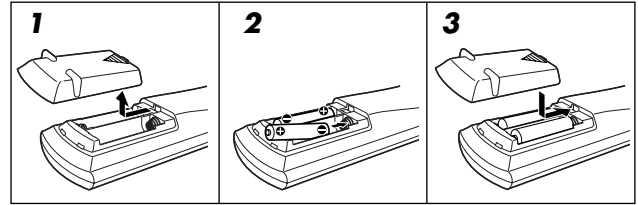

1 Press and slide the battery cover on the back of the remote control.

2 Insert batteries.

Make sure to match the polarity: (+) to (+) and (-) to (-).

3 Replace the cover.

If the range or effectiveness of the remote control decreases, replace the batteries. Use two R6(SUM-3)/AA(15F) type dry-cell batteries.

- Supplied batteries are for initial setup. Replace for continued use.

CAUTION:

Follow these precautions to avoid leaking or cracking cells:

- Place batteries in the remote control so they match the polarity: (+) to (+) and (-) to (-).
- Use the correct type of batteries. Batteries that look similar may differ in voltage.
- Always replace both batteries at the same time.
- Do not expose batteries to heat or flame.

When using the remote control, aim the remote control directly at the remote sensor on the front panel.

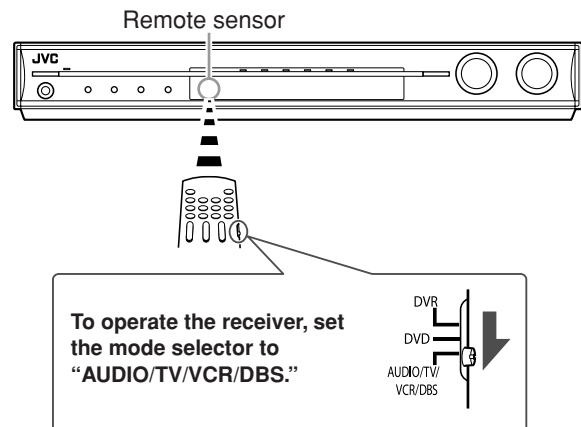

Setting the voltage selector

Before connections, always do the following first if necessary.

Select the correct voltage in VOLTAGE SELECTOR on the rear of the receiver by using a screw driver.

- Check to be sure if the voltage mark is set to the voltage for your area where this unit plugs in.

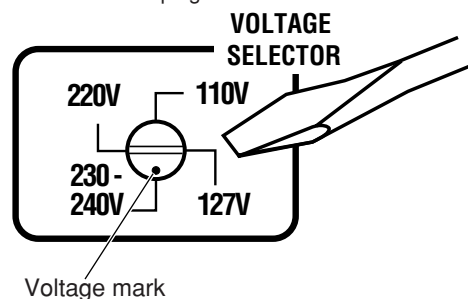

Connecting the FM and AM antennas

Do not connect the AC power plug to the wall outlet until all connections are completed.

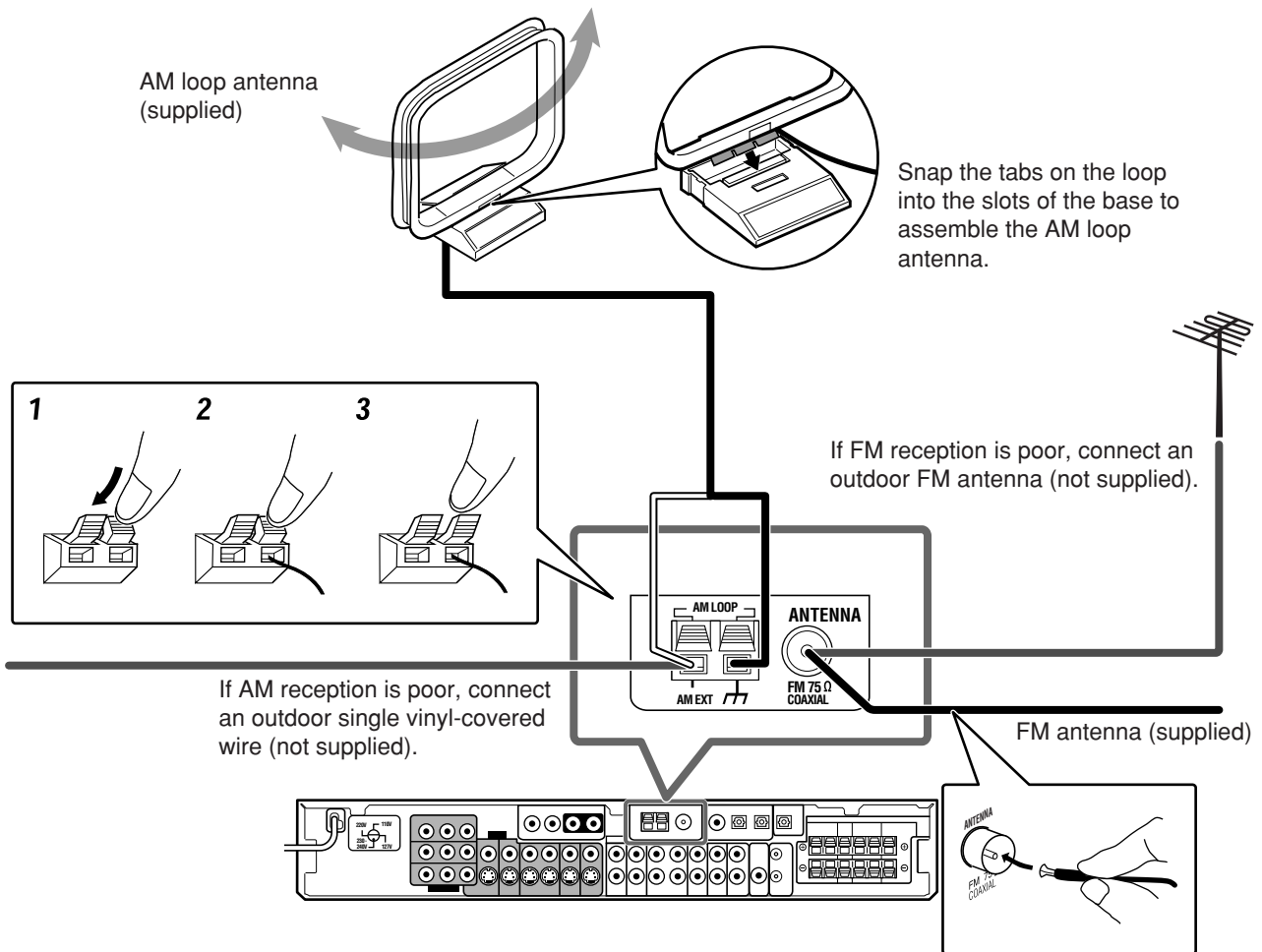

AM antenna connection

Connect the AM loop antenna supplied to the AM LOOP terminals.

Connect the white cord to the AM EXT terminal, and connect the black cord to the ⏏ terminal.

Turn the loop until you have the best reception.

- If the reception is poor, connect an outdoor single vinyl-covered wire (not supplied) to the AM EXT terminal. Keep the AM loop antenna connected.

FM antenna connection

Connect the FM antenna supplied to the FM 75 Ω COAXIAL terminal as a temporary measure.

Extend the supplied FM antenna horizontally.

- If the reception is poor, connect an outdoor FM antenna (not supplied). Before attaching a 75 Ω coaxial cable with a connector (IEC or DIN 45325), disconnect the supplied FM antenna.

NOTES

- If the AM loop antenna wire is covered with vinyl, remove the vinyl while twisting it as shown on the right.
- Make sure the antenna conductors do not touch any other terminals, connecting cords and power cord. This could cause poor reception.

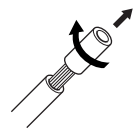

Connecting the speakers

Do not connect the AC power plug to the wall outlet until all connections are completed.

Speaker Layout Diagram

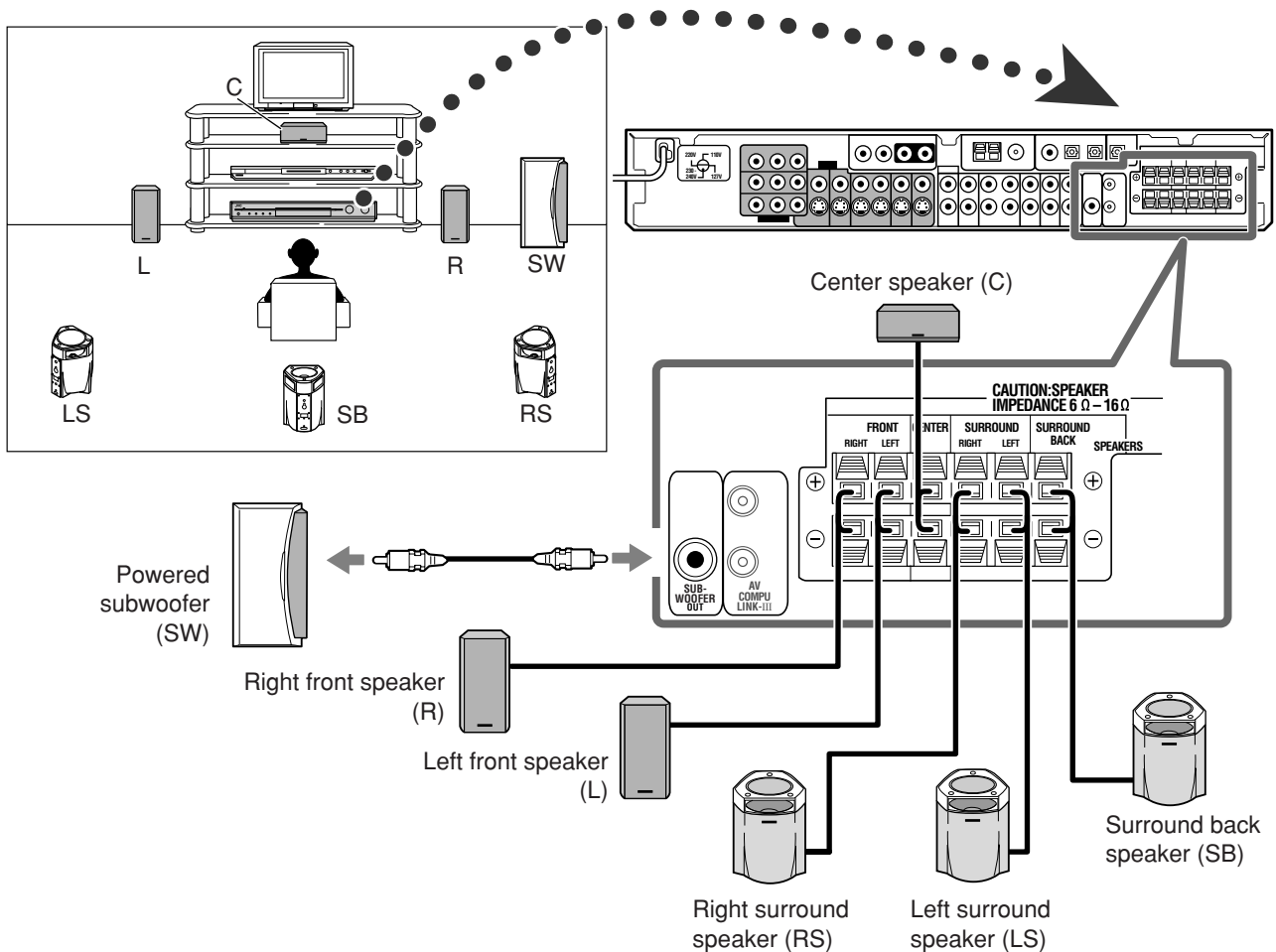

Connecting the speakers

Turn off all components before making connections.

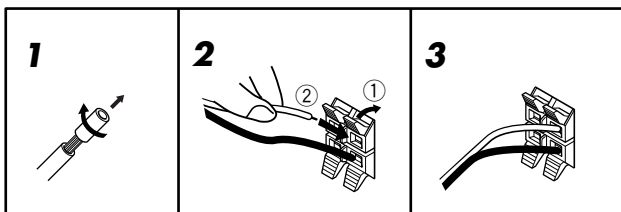

1 Twist and remove the insulation at the end of each speaker cord.

2 Press and hold the clamp of the speaker terminal (①), then insert the speaker cord (②).

- For each speaker, connect the (+) and (-) terminals on the rear panel to the (+) and (-) terminals marked on the speakers.

3 Release the finger from the clamp.

CAUTIONS:

- Use speakers with the SPEAKER IMPEDANCE indicated by the speaker terminals (6 Ω – 16 Ω).
- DO NOT connect more than one speaker to one speaker terminal.

Connecting the powered subwoofer

By connecting a subwoofer, you can enhance the bass or reproduce the original LFE signals recorded in digital software.

Connect the input jack of a powered subwoofer to the SUBWOOFER OUT jack on the rear panel, using a cord with RCA pin plugs (not supplied).

- Refer also to the manual supplied with your subwoofer.

After connecting all the speakers and/or a subwoofer, set the speaker setting information properly to obtain the best possible surround effect. For details, see pages 16, 17, and 21 to 23.

NOTE

You can place a subwoofer wherever you like since bass sound is non-directional. Normally place it in front of you.

Connecting video components

Do not connect the AC power plug to the wall outlet until all connections are completed.

This receiver is equipped with the following video terminals—composite video, S-video, and component video terminals.

- If your video components have S-video (Y/C-separation) and/or component video (Y, P_B, P_R) jacks, connect them using an S-video cable (not supplied) or component video cable (not supplied). By using these terminals, you can get a better picture quality in the order:

Component > S-video > Composite

IMPORTANT:

Component video signals are transmitted only through component video output jacks. Therefore, if a recording video component and a playing video component are connected to the receiver through the video terminals of different type, you cannot record the picture. In addition, if the TV and a playing video component are connected to the receiver through the video terminals of different type, you cannot view the playback picture on the TV. On the other hand, S-video signals and composite video signals can be converted into each other and transmitted through the corresponding output jack. For details about the settings of the conversion, see page 25.

Turn off all components before making connections.

- When you connect other components, refer also to their manuals.

DO NOT use a TV through a VCR or a TV with a built-in VCR; otherwise, the picture may be distorted.

CAUTION:

If you connect a sound-enhancing device such as a graphic equalizer between the source components and this receiver, the sound output through this receiver may be distorted.

If your video components have AV COMPU LINK terminal

See also page 40 for detailed information about the connection and the AV COMPU LINK remote control system.

■ Connecting a DVD recorder or DVD player with its stereo output jacks (DVR/DVD):

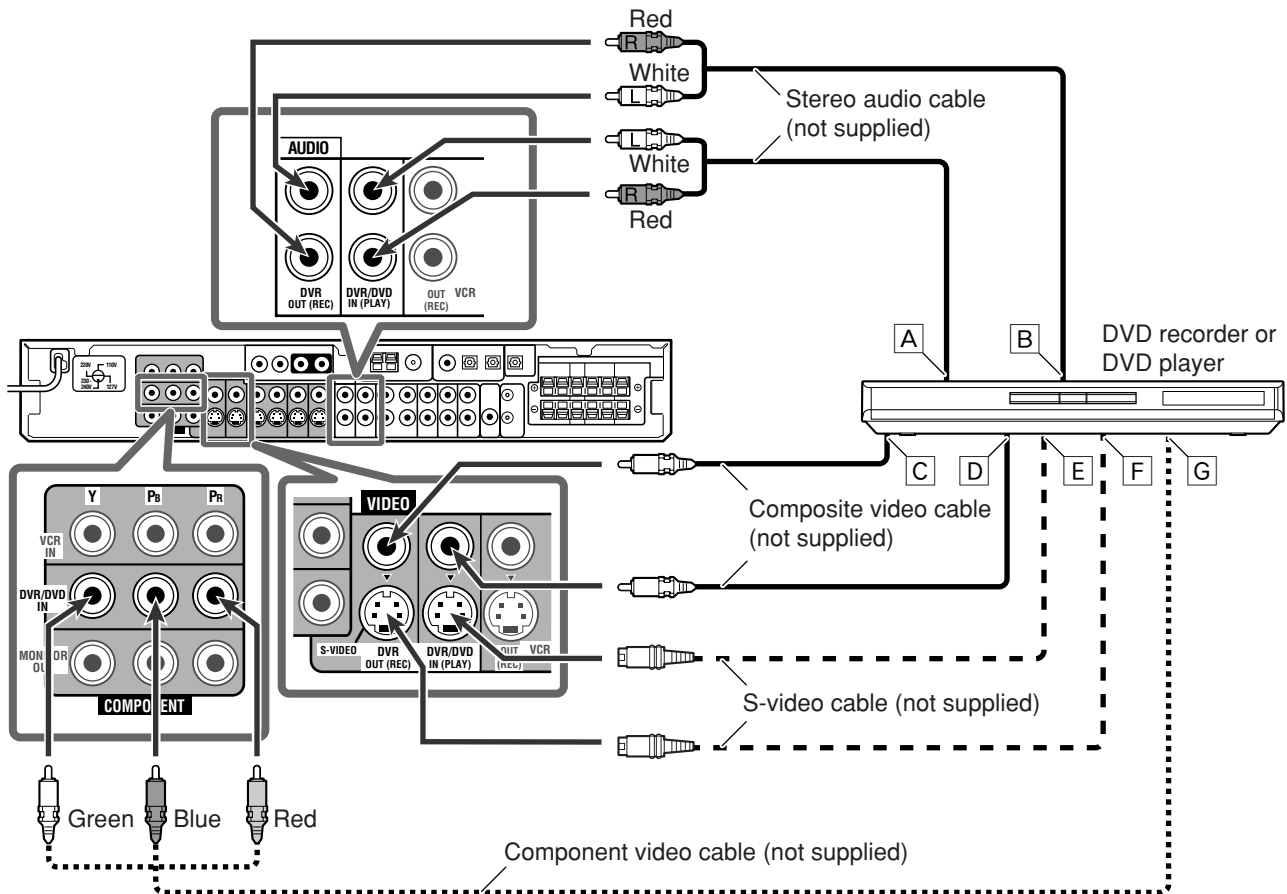

NOTES

- When connecting a DVD recorder or DVD player to the component video input jacks, make the component video input setting (DVD VIDEO INPUT) correctly. If you do not, you cannot view the playback picture on the TV or the AV COMPU LINK remote control system cannot operate properly. For details, see page 25.
- You can enjoy digital sound if using a digital coaxial or optical cable. When shipped from the factory, the audio input mode for a DVD recorder and DVD player is set to use the digital coaxial terminal (DIGITAL IN 1 (DVR/DVD)). For details of digital connection, see page 11.

- A To left/right audio channel output
- B **Only for DVD recorder:** To left/right audio channel input
- C **Only for DVD recorder:** To composite video input
- D To composite video output
- E To S-video output
- F **Only for DVD recorder:** To S-video input
- G To component video output
 - Connect Y, P_B, and P_R correctly.

■ Connecting a DVD recorder or DVD player with its analog discrete output jacks (DVD MULTI IN):

This connection is the best connection method for enjoying DVD Audio sounds. When a DVD Audio disc is played back, the original high-quality sounds can be reproduced only using this connection.

Turn off all components before making connections.

- When you connect other components, refer also to their manuals.

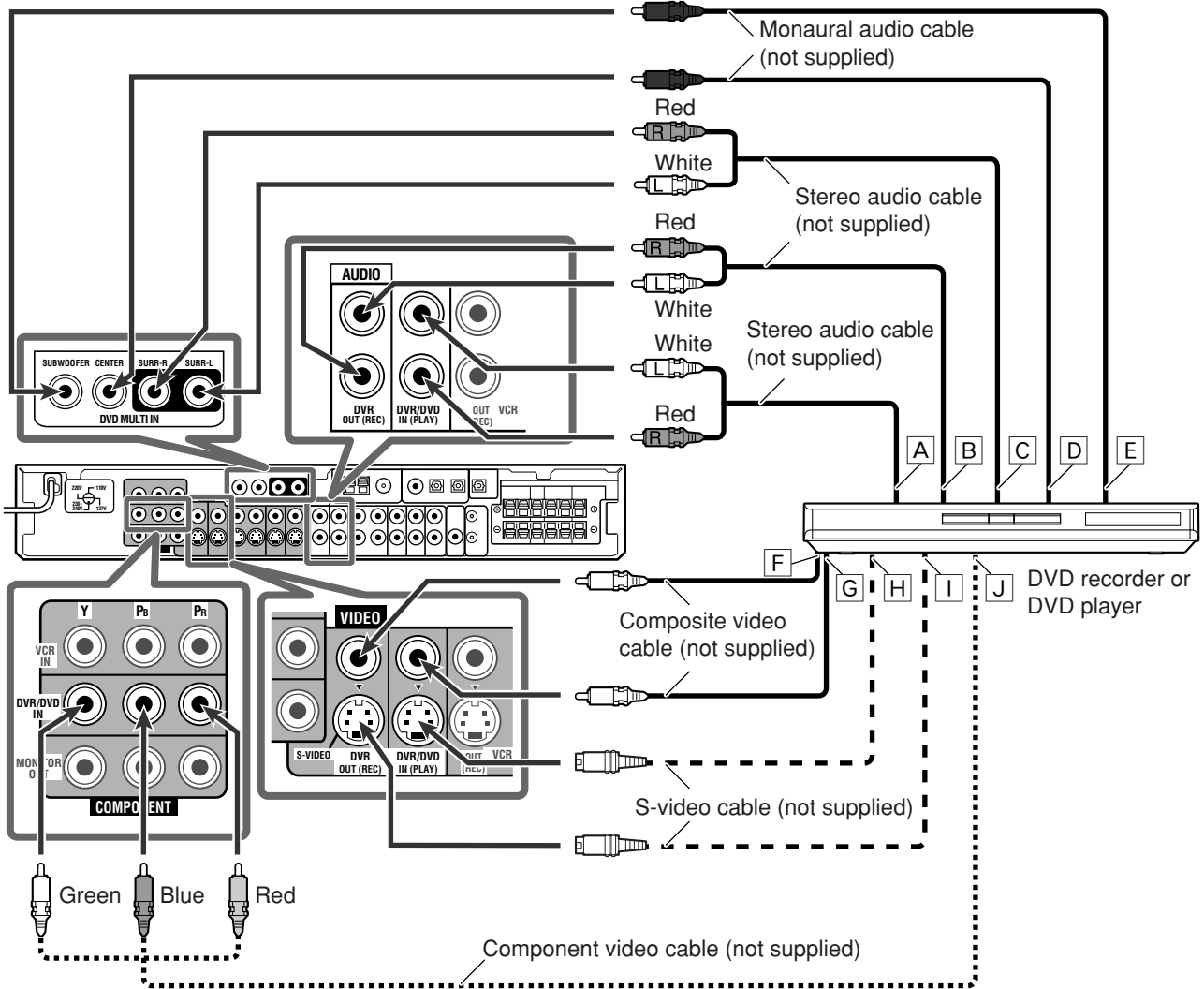

NOTE

When connecting a DVD recorder or DVD player to the component video input jacks, make the component video input setting (DVD VIDEO INPUT) correctly. If you do not, you cannot view the playback picture on the TV or the AV COMPU LINK remote control system cannot operate properly. For details, see page 25.

- A To left/right front channel audio output
- B **Only for DVD recorder:** To left/right front channel audio input
- C To left/right surround channel audio output
- D To center channel audio output
- E To subwoofer output
- F **Only for DVD recorder:** To composite video input
- G To composite video output
- H To S-video output
- I **Only for DVD recorder:** To S-video input
- J To component video output
 - Connect Y, Pb, and Pr correctly.

About "DVD MULTI"

When you select "DVD MULTI" as the source (see page 12), you can enjoy analog discrete output sound (5.1-channel reproduction) from the connected component.

- You may need to select analog discrete output mode on the component.

NOTES

- When using the headphones, you can listen to the front channel sounds (left and right) only. 3D HEADPHONE mode (see pages 36 and 37) is not available.
- When TV Direct is activated while "DVD MULTI" is selected as the source, the source changes to the last selected source—"DVR/DVD," "VCR," and "DBS" (see page 14).
- Surround/DSP modes (see pages 34 to 39) are not available for "DVD MULTI."

■ Connecting a VCR

Turn off all components before making connections.
 • When you connect other components, refer also to their manuals.

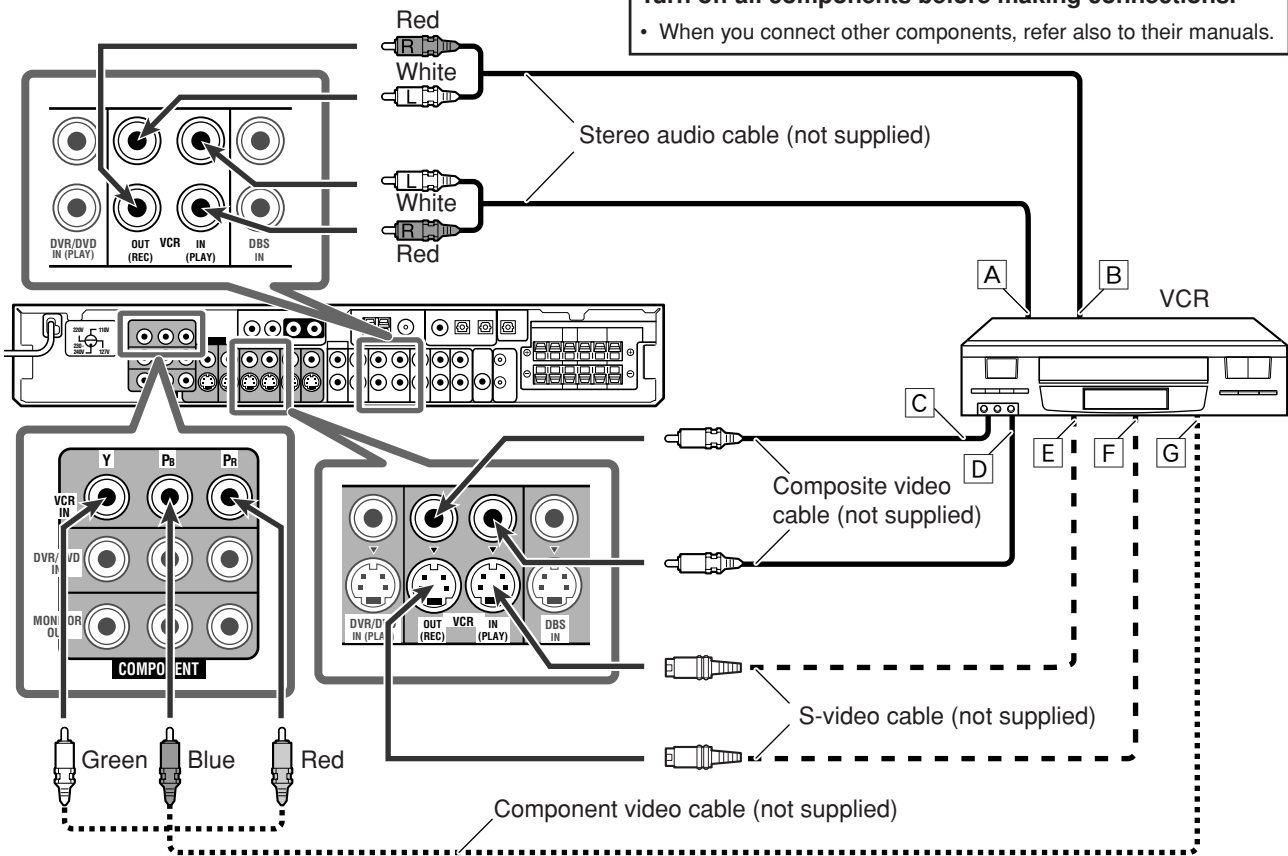

NOTES

- When connecting a VCR to the component video input jacks, make the component video input setting (VCR VIDEO INPUT) correctly. If you do not, you cannot view the playback picture on the TV or the AV COMPU LINK remote control system cannot operate properly. For details, see page 25.
- You can enjoy digital sound if using a digital coaxial or optical cable. When shipped from the factory, the audio input mode for a video component other than DVD recorder and DVD player is set to use the digital optical terminal (DIGITAL IN 3 (VCR)). For details of digital connection, see page 11.

- A To left/right audio channel output
 - B To left/right audio channel input
 - C To composite video input
 - D To composite video output
 - E To S-video output
 - F To S-video input
 - G To component video output
- Connect Y, P_B, and P_R correctly.

■ Connecting a DBS tuner

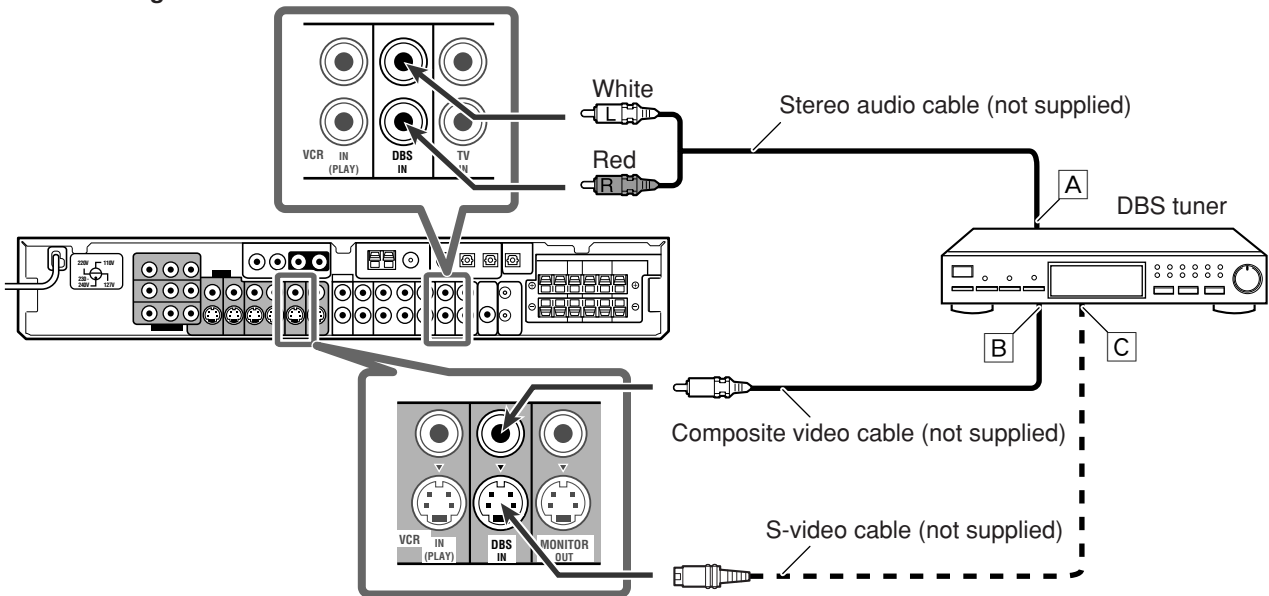

NOTE

You can enjoy digital sound if using a digital coaxial or optical cable. When shipped from the factory, the audio input mode for a TV is set to use the digital optical terminal (DIGITAL IN 2 (DBS)). For details of digital connection, see page 11.

- A To left/right audio channel output
- B To composite video output
- C To S-video output

■ Connecting a TV

Connect the TV to the appropriate MONITOR OUT jacks to view the playback picture from any other connected video components.

Turn off all components before making connections.

- When you connect other components, refer also to their manuals.

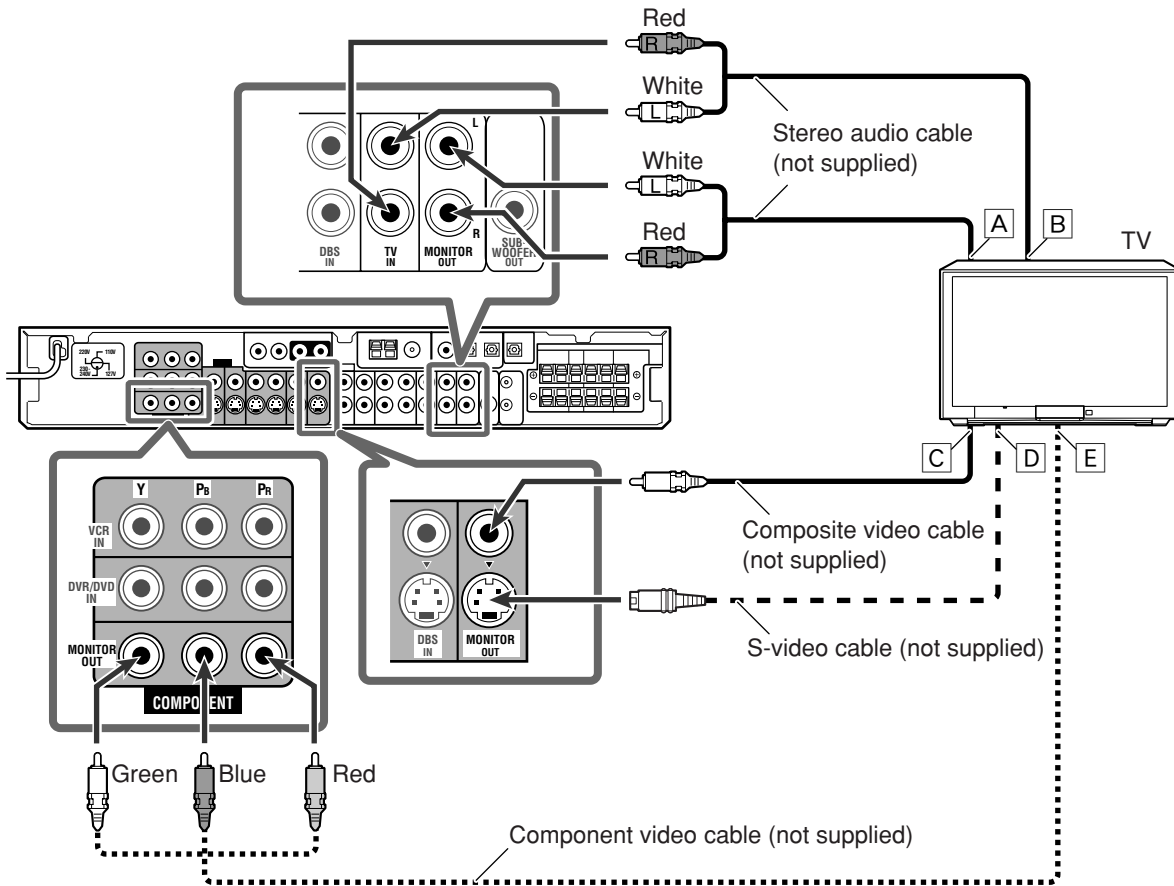

NOTES

- You can enjoy digital sound if using a digital coaxial or optical cable. For details of digital connection, see page 11.
- When connecting a TV through the COMPONENT MONITOR OUT jacks, the on-screen display does not appear on the TV screen (see page 25).

- A** To left/right audio channel input
 - B** To left/right audio channel output
 - C** To composite video input
 - D** To S-video input
 - E** To component video input
- Connect Y, Pb, and Pr correctly.

IMPORTANT:

Audio signals come out through the MONITOR OUT (L/R) jacks ONLY when TV Direct is in use (see page 14). Connect these jacks to the audio input jacks corresponding to the video connection; otherwise, no sound comes out of the TV speaker when TV Direct is in use.

Digital connection

This receiver is equipped with three DIGITAL IN terminals—one digital coaxial terminal and two digital optical terminals—and one DIGITAL OUT terminal.

To reproduce the digital sound, use the digital connection in addition to the analog connection methods described on pages 7 to 10.

Digital coaxial cable (supplied: 1 cable)



Digital optical cable (not supplied)



Turn off all components before making connections.

- When you connect other components, refer also to their manuals.

Digital input terminals

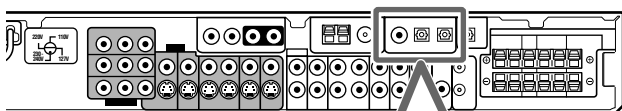

When the component has a digital coaxial output terminal, connect it to the 1(DVR/DVD) terminal, using a digital coaxial cable (supplied).

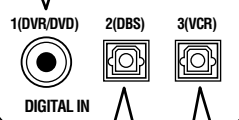

When the component has a digital optical output terminal, connect it to the 2(DBS) or 3(VCR) terminal, using a digital optical cable (not supplied).

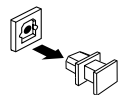

Before connecting a digital optical cable, unplug the protective plug.

NOTES

- When shipped from the factory, the DIGITAL IN terminals have been set for use with the following components:
 - 1(DVR/DVD): For DVD recorder or DVD player
 - 2(DBS): For DBS tuner
 - 3(VCR): For VCR
- If you connect other components, change the digital input (DIGITAL IN) terminal setting correctly. See "Setting the digital input (DIGITAL IN) terminals—DIGITAL IN 1/2/3" on page 24.
- Select the digital input mode. See "Selecting the analog or digital input mode" on page 12.
- When you want to operate the connected component (except DBS tuner) using the AV COMPU LINK remote control system (see pages 40 and 41), connect them also as described on pages 7 to 10.

Digital output terminal

You can connect any digital components which have an optical digital input terminal.

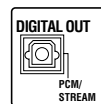
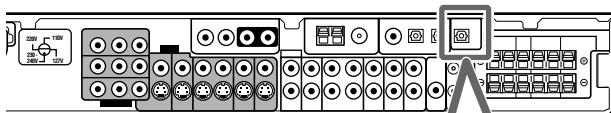

Connecting digital recording equipment to the DIGITAL OUT terminal enables you to perform digital-to-digital recording.

NOTE

The digital signal format transmitted through the DIGITAL OUT terminal is the same as that of the input signal. For example, when the DTS signals are input, the DTS signals are transmitted.

Connecting the power cord

When all the audio/video connections have been made, connect the AC power plug to the wall outlet. Make sure that the plugs are inserted firmly. The standby lamp lights in red.

CAUTIONS:

- Do not plug in before setting the VOLTAGE SELECTOR switch on the rear of the receiver and all connection procedures are complete.
- Do not touch the power cord with wet hands.
- Do not alter, twist or pull the power cord, or put anything heavy on it, which may cause fire, electric shock, or other accidents.
- If the cord is damaged, consult a dealer and have the power cord replaced with a new one.

NOTES

- Keep the power cord away from the connecting cables and the antenna. The power cord may cause noise or screen interference.
- The preset settings such as preset channels and sound adjustment may be erased in a few days in the following cases:
 - When you unplug the power cord.
 - When a power failure occurs.
- If the wall outlet does not match the AC plug, use the supplied AC plug adaptor.

Basic operations

The on-screen display appears on the TV screen for 5 seconds (except "turning off the sounds temporarily") to show the indication in the following cases:

- When you select the source (see right column).
- When you adjust the volume (see page 13).
- When you turn off the sounds temporarily (see page 15).
- When you select the Surround/DSP modes (see page 39).

To cancel the function, set "SUPERIMPOSE" to "SUPERIMPOSE: OFF" (see page 25).

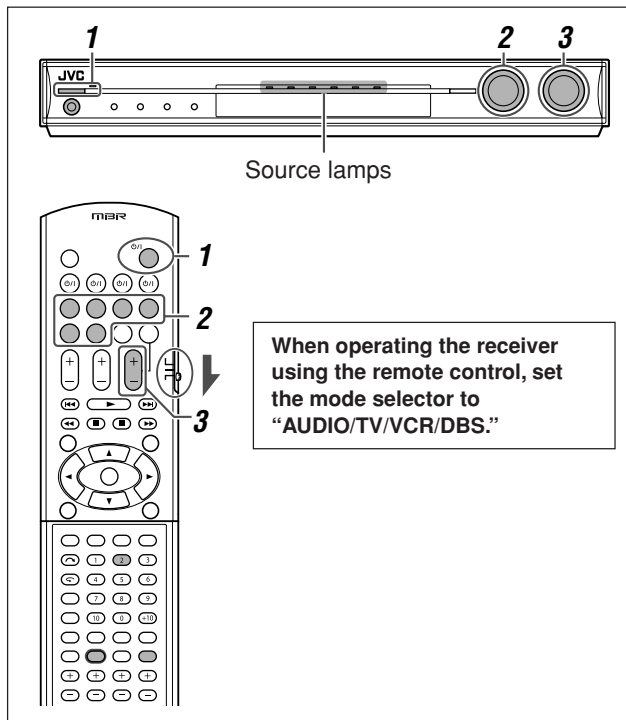

1 Turn on the power

Press **⏻/I STANDBY/ON** (or **⏻/I AUDIO** on the remote control).

The standby lamp goes off and the source lamp of the current source lights in red.

Current source name appears.

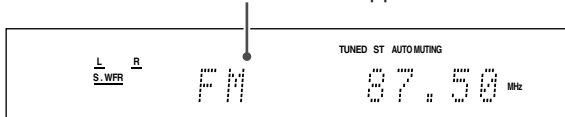

To turn off the power (into standby)

Press **⏻/I STANDBY/ON** (or **⏻/I AUDIO** on the remote control) again.

The standby lamp lights in red.

NOTE

A small amount of power is consumed in standby mode. To turn the power off completely, unplug the AC power cord.

2 Select the source to play

On the front panel:

Turn **SOURCE SELECTOR** until the source name you want appears on the display.

The source lamp corresponding to the selected source lights in red.

- As you turn SOURCE SELECTOR, the source changes as follows:

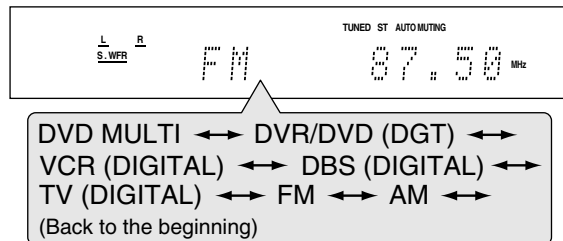

DVD MULTI:	Select for the DVD player using the analog discrete output mode (5.1-channel reproduction).
DVR/DVD (DGT)*:	Select for the DVD recorder or DVD player.
VCR (DIGITAL)*:	Select for the VCR.
DBS (DIGITAL)*:	Select for the DBS tuner.
TV (DIGITAL)*:	Select for the TV.
FM:	Select for an FM broadcast.
AM:	Select for an AM broadcast.

From the remote control:

Press one of the source selecting buttons.

- For the tuner, press FM/AM. Each time you press FM/AM, the band alternates between "FM" and "AM."

* Selecting the analog or digital input mode

For a component you have connected using both the analog connection and the digital connection methods (see pages 7 to 11), you need to select the correct input mode.

- You can select the digital input only for sources which you have selected digital input terminals for. (See "Setting the digital input (DIGITAL IN) terminals—DIGITAL IN 1/2/3" on page 24.)

From the remote control ONLY:

Press **ANALOG/DIGITAL INPUT** to select the analog or digital input mode.

- Each time you press the button, the input mode alternates between the analog input ("ANALOG") and the digital input ("DGTL AUTO").

This setting is memorized for each source.

DGTL AUTO: Select for the digital input mode. The receiver automatically detects the incoming signal format, then the digital signal format indicator (LPCM, DOLBY D, DTS, or DTS 96/24) for the detected signal lights up.

ANALOG: Select for the analog input mode.

Initial setting: DGTL AUTO

NOTE

When you select "DVD MULTI," "FM," or "AM" as the source, the analog and digital input mode is not available.

3 Adjust the volume

To increase the volume, turn **MASTER VOLUME** control clockwise (or press **VOLUME +** on the remote control).

To decrease the volume, turn **MASTER VOLUME** control counterclockwise (or press **VOLUME -** on the remote control).

- When you adjust the volume, the volume level indication appears on the display for a while.

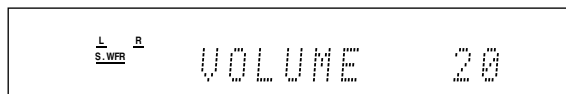

CAUTION:

Always set the volume to the minimum before starting any sources. If the volume is set at its high level, the sudden blast of sound energy can permanently damage your hearing and/or ruin your speakers.

NOTE

The volume level can be adjusted within the range of "0" (minimum) to "50" (maximum).

Listening with headphones

You can enjoy not only stereo software but also multi-channel software through the headphones. (Sounds are down-mixed to the front channels while playing multi-channel software.)

Connect a pair of headphones to the PHONES jack on the front panel to activate the HEADPHONE mode.

The HP (headphone) indicator lights up on the display.

- You can also enjoy the Surround/DSP mode through the headphones—3D HEADPHONE mode. For details, see pages 36 and 37.
- Disconnecting a pair of headphones from the PHONES jack cancels the HEADPHONE (or 3D HEADPHONE) mode and activates the speakers.

CAUTION:

Be sure to turn down the volume:

- Before connecting or putting on headphones, as high volume can damage both the headphones and your hearing.
- Before removing headphones, as high volume may output from the speakers.

Selecting the digital decode mode

If the following symptoms occur while playing Dolby Digital or DTS software with "DGTL AUTO" selected (see page 12), follow the procedure below:

- Sound does not come out at the beginning of playback.
- Noise comes out while searching for or skipping chapters or tracks.

From the remote control ONLY:

Press SOUND, then press DECODE to select "DOLBY D" or "DTS."

- Each time you press DECODE, the digital decode mode changes as follows:

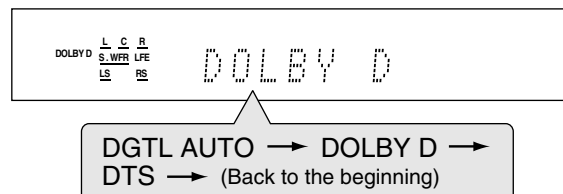

- To play back software encoded with Dolby Digital, select "DOLBY D."
- To play back software encoded with DTS, select "DTS."

NOTES

- When you turn off the power or select another source, "DOLBY D" or "DTS" is canceled and the digital decode mode is automatically reset to "DGTL AUTO."
- After pressing SOUND, the numeric buttons work for sound adjustments. To use the numeric buttons to operate your target source, press the corresponding source selecting button before operation; otherwise, the remote control may not work as you intend.

The following digital signal format indicators on the display indicate what type of signal comes into the receiver.

- LPCM:** Lights up when Linear PCM signal comes in.
- DOLBY D:**
- Lights up when Dolby Digital signal comes in.
 - Flashes when "DOLBY D" is selected for any software other than Dolby Digital.
- DTS:**
- Lights up when conventional DTS signal comes in.
 - Flashes when "DTS" is selected for any software other than DTS.
- DTS 96/24:** Lights up when DTS 96/24 signal comes in.

NOTE

When "DGTL AUTO" cannot recognize the incoming signal, no digital signal format indicator lights up on the display.

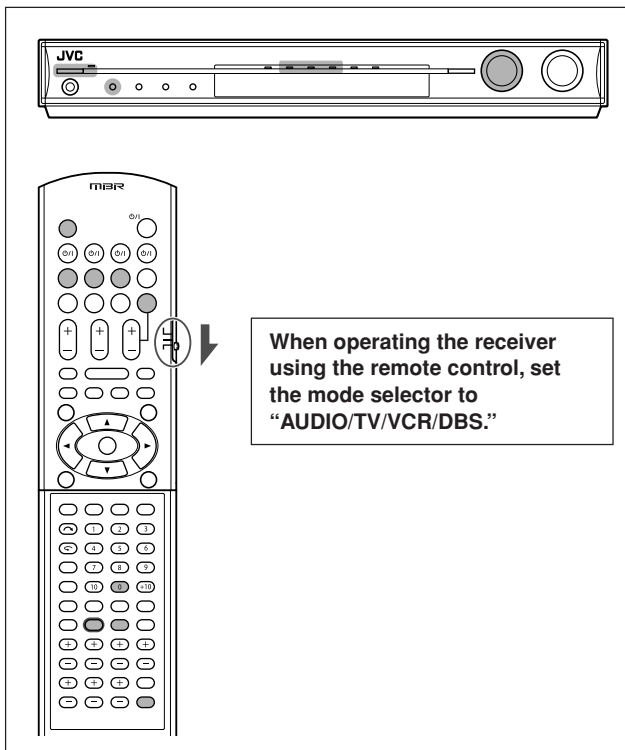

Adjusting the subwoofer audio position

If the subwoofer sound is much reinforced for stereo sound compared to the sound reproduced with multi-channel, set the subwoofer audio position. The subwoofer output level is automatically decreased by the selected value when you are listening in stereo.

The AUDIO P. indicator lights up when this function is activated.

- Once you have made an adjustment, it is memorized for each source.

From the remote control ONLY:

Press SOUND, then press A.POSITION repeatedly.

- Each time you press A.POSITION, the subwoofer audio position level changes as follows:

AUDIO P. indicator

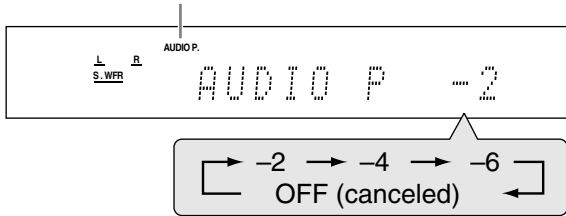

The smaller the number becomes, the more the level decreases automatically when listening in stereo.

- If no adjustment is required, select "OFF" (initial setting).

NOTES

- The minimum subwoofer output level is -10 dB.
Ex.: When setting the subwoofer output level to "-8 (dB)" and the subwoofer audio position to "-4 (dB)," the subwoofer output level when listening in stereo will be -10 dB.
To adjust the subwoofer output level, see page 29.
- This function is not available when the Surround/DSP mode is activated or "DVD MULTI" is selected.
- After pressing SOUND, the numeric buttons work for sound adjustments. To use the numeric buttons to operate your target source, press the corresponding source selecting button before operation; otherwise, the remote control may not work as you intend.

Activating TV Direct

TV Direct enables you to use this receiver as an AV selector **while the receiver is turned off.**

When TV Direct is activated, the pictures and sounds go from the video components such as DVD player to the TV through this receiver. Thus, you can use the video components and the TV as if they were connected directly.

- This function takes effect for the following sources—DVR/DVD, VCR, and DBS.

To activate (or deactivate) TV Direct, follow the procedure below:

1 Press TV DIRECT.

All the indications disappear, then the source lamp of the current source lights in green.

2 Turn on the video component and TV.

3 Select the target video component.

On the front panel:

Turn SOURCE SELECTOR until one of the source lamps—DVR/DVD, VCR, or DBS—lights in green.

From the remote control:

Press one of the source selecting buttons—DVR/DVD, VCR, or DBS.

The source lamp corresponding to the selected source lights in green.

To cancel TV Direct and turn off the receiver, press \odot /I STANDBY/ON on the front panel (or \odot /I AUDIO on the remote control).

The receiver is turned off and the standby lamp lights up.

To cancel TV Direct and turn on the receiver, press TV DIRECT again.

The receiver is turned on and the source lamp currently selected lights in red.

NOTES

- When TV Direct is activated, you cannot enjoy any of the sound effects the receiver produces, and cannot use the speakers connected to the receiver.
- When TV Direct is activated while "DVD MULTI," "FM," or "AM" is selected as the source, the source changes to the last selected source—"DVR/DVD," "VCR," or "DBS."

Turning off the sounds temporarily

From the remote control ONLY:

Press **MUTING** to turn off the sound through all connected speakers and headphones.

"MUTING" appears on the display and the volume turns off.



To restore the sound, press **MUTING** again.

- Pressing **VOLUME +/-** (or turning **MASTER VOLUME** control on the front panel) also restores the sound.

Changing the display brightness

You can dim the display—Dimmer.

From the remote control ONLY:

Press **DIMMER** repeatedly.

- Each time you press the button, the display brightness changes as follows:

- DIMMER 1:** Dims the display slightly.
Dims the blue illumination slightly.
- DIMMER 2:** Dims the display more than DIMMER 1.
Dims the blue illumination slightly (more than DIMMER 1).
- DIMMER 3:** Turns off the display and blue illumination.
(Temporarily canceled when you operate the receiver.*)
- DIMMER OFF:** Cancels the Dimmer (normal display).

* Except when activating or deactivating TV Direct.

Turning off the power with the Sleep Timer

You can fall asleep while listening to music—Sleep Timer.

From the remote control ONLY:

Press **SLEEP** repeatedly.

- Each time you press the button, the shut-off time changes in 10 minute intervals. The **SLEEP** indicator lights up on the display.

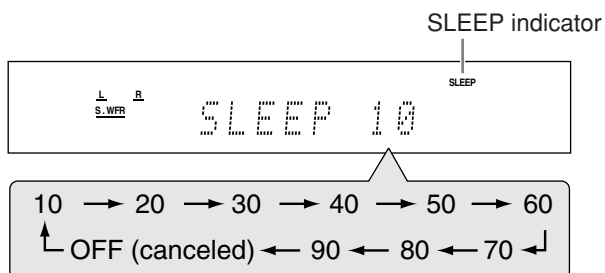

When the shut-off time comes:

The receiver turns off automatically.

To check or change the remaining time until the shut-off time:

Press **SLEEP** once.

The remaining time (in minutes) until the shut-off time appears.

- To change the shut-off time, press **SLEEP** repeatedly.

To cancel the Sleep Timer:

Press **SLEEP** repeatedly so that "SLEEP OFF" appears on the display. (The **SLEEP** indicator goes off.)

- The Sleep Timer is also canceled when:
 - You turn off the receiver, or
 - TV Direct is activated.

Basic adjustment of auto memory

This receiver memorizes sound settings for each source:

- when you turn off the power, and
- when you change the source.

When you change the source, the memorized settings for the newly selected source are automatically recalled.

The following can be stored for each source:

- Analog/digital input mode (see page 12)
- Subwoofer audio position (see page 14)
- Midnight mode (see page 24)
- Speaker output level (see page 29)
- Digital equalization pattern (see page 30)
- Bass boost (see page 30)
- Subwoofer phase (see page 30)
- Input attenuator mode (see page 30)
- Surround/DSP mode selection (see page 39)

NOTE

If the source is "FM" or "AM," you can assign a different setting for each band.

Signal and speaker indicators on the display

Signal indicators

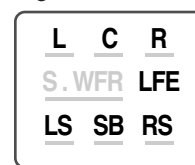

Speaker indicators

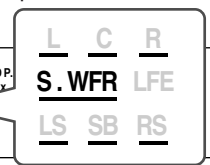

The signal indicators light up as follows:

- L:**
- When digital input is selected:** Lights up when the left channel signal comes in.
 - When analog input is selected:** Always lights up.
- R:**
- When digital input is selected:** Lights up when the right channel signal comes in.
 - When analog input is selected:** Always lights up.
- C:** Lights up when the center channel signal comes in.
- LS*:** Lights up when the left surround channel signal comes in.
- RS*:** Lights up when the right surround channel signal comes in.
- SB:** Lights up when the surround back channel signal comes in.
- LFE:** Lights up when the LFE channel signal comes in.

* When monaural surround signal comes in, only "S" lights up.

NOTE

When "DVD MULTI" is selected as the source, all the signal indicators except "SB" light up.

The speaker indicators light up as follows:

- The subwoofer indicator (**S.WFR**) lights up when "SUBWOOFER" is set to "SUBWOOFER: YES." For details, see page 21.
- The other speaker indicators light up only when the corresponding speaker is set to "SMALL" or "LARGE," and also when required for the current playback.

Basic settings

To obtain the best possible sound effect from Surround/DSP modes (see pages 34 to 39), you need to set up the speaker and subwoofer information after all the connections are completed. From pages 16 to 25, how to set speakers and other basic items of the receiver are explained.

Setting the speaker information automatically—Smart Surround Setup

The distance from your listening point to the speakers is one of the important elements to obtain the best possible sound effect from the Surround/DSP modes.

By using Smart Surround Setup, the following are automatically calculated by one simple action—clapping hands.

- Speaker distance (compared to that of the closest speaker)
- Speaker output level (except the subwoofer)

NOTES

- Before starting Smart Surround Setup, set the speaker information correctly (SMALL, LARGE, or NO) according to your speakers except the subwoofer (see page 21).
- The speakers which are set to “NO” in the speaker setting (see page 21) are not indicated clearly on the TV screen.
- When the setting is made by Smart Surround Setup, the speaker distance and output level you have set before will be inactive.
- You can see the setting process on the TV screen and the display during Smart Surround Setup. If you have turned off the display, cancel the Dimmer (see page 15); otherwise, you cannot see the information on the display.
- Smart Surround Setup will not be done correctly if you or other object blocks the sound.
- When you change your speakers, do the following procedure again.

In this section, the on-screen display on the TV screen is used for explaining.

- The on-screen display does not appear on the TV screen when connecting the TV through the COMPONENT MONITOR OUT jacks (see page 10).

From the remote control ONLY:

When operating the receiver using the remote control, set the mode selector to “AUDIO/TV/VCR/DBS.”

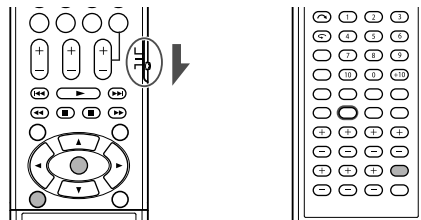

1 Take your position where you listen to the sound.

- Make sure speaker cables are connected firmly.

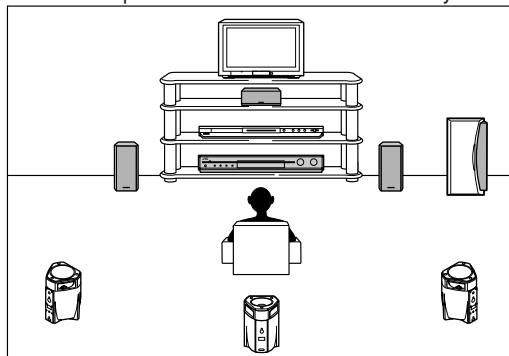

2 Press and hold SMART SURROUND SETUP until “SETTING UP” flashes.

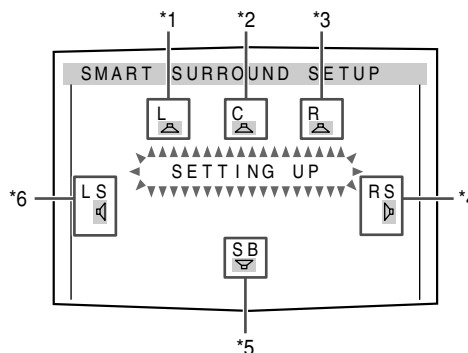

- *1 L: Left front speaker
- *2 C: Center speaker
- *3 R: Right front speaker
- *4 RS: Right surround speaker
- *5 SB: Surround back speaker
- *6 LS: Left surround speaker

3 When “CLAP YOUR HANDS.” appears, clap your hands over your head once while the indications still remain.

- On the display, “SETTING UP” stops flashing.

The receiver starts detecting the level of the sound coming through each speaker (except the subwoofer).

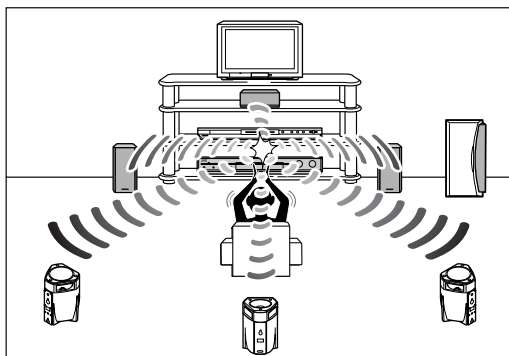

When your clapping sound is detected successfully,

- On the TV screen, "SUCCESSFUL," "RESULT," and the setting values appear. The setting values are shown for about 12 seconds.

Ex.:

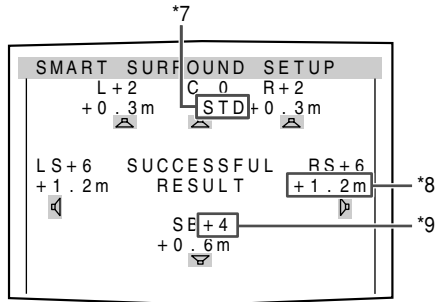

- On the display, "SUCCESSFUL" appears, then the setting values are shown as follows for about 12 seconds:

Ex.:

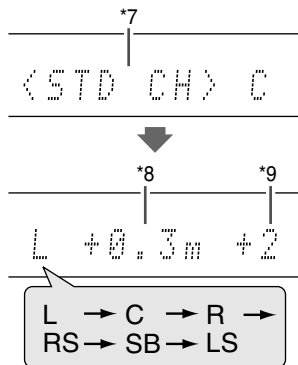

- *7 Standard channel (the closest speaker). This speaker position now works as the reference position ("0m/ft") and other speakers' distance is shown by the difference with this reference speaker position.
- *8 Difference of each speaker position in distance (in meters or feet).
- *9 Each speaker's output level (-6 to +6).

When finishing to show the setting values,

On the TV screen, "COMPLETED" appears, then "TEST TONE" and "END" appear. On the display, "TEST? END?" appears.

- To adjust the speakers' output levels manually, press TEST TONE (see page 29).
- To disappear the on-screen display, press SET or any button except TEST TONE.
- The receiver returns to normal operation mode automatically if no operations are done for about 10 seconds.

Ex.:

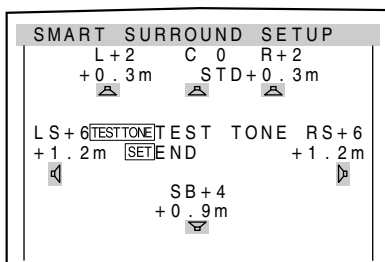

When your clapping sound is not detected correctly,

"SETTING UP" appears again after one of the following messages. In this case, repeat step 3.

- SILENT:**
 - The receiver detects sound from only the left and right front speakers.
 - The receiver detects no sound from the front speakers and detects sound from at least one of other speakers.
- SILENT-ALL:** The receiver cannot detect any sound from any speaker for about 10 seconds.
- AGAIN:**
 - The receiver cannot detect sound from the left or right front speaker.
 - The receiver fails to calculate the speakers' output level and difference of each speaker's position in distance.

In the following cases, set the speakers manually.

- When "SILENT" appears twice in succession.**

The setting is partially made. (The distance of the speakers from which sound has not been detected is set to "+9.0m (+30ft).")

The receiver exits from Smart Surround Setup.

- When "MANUAL" appears.**

The receiver fails to detect the sound three times. The receiver exits from Smart Surround Setup.

To cancel Smart Surround Setup, press SMART SURROUND SETUP while "SETTING UP" flashes.

- No other operations can be accepted after "SETTING UP" stops flashing. Complete the Smart Surround Setup.

To check the current setting made by Smart Surround Setup,

press SMART SURROUND SETUP while the receiver is in normal operation mode.

The setting values appear. On the display, the setting values are shown one after another.

- The current setting is not indicated but "MANUAL" appears if you change the following settings after using Smart Surround Setup:
 - If you change speaker distance manually.
 - If you change one of the speaker sizes either from "NO" to "SMALL" or "LARGE," or from "SMALL" or "LARGE" to "NO."
 To check the current setting, see each setting item of the speaker distance (see page 22) and the speaker output level (see page 29).
- If you have not used Smart Surround Setup, "NO S.S.S." appears.

NOTES

- The speaker distance and output level manually set will be applied instead of those set by using Smart Surround Setup in the following cases:
 - When you change one of the speaker distance (see page 22).
 - When you change one of the speaker size either from "NO" to "SMALL" or "LARGE," or from "SMALL" or "LARGE" to "NO" (see page 21).
- When you want to adjust the speaker distance and output level manually, see pages 22 and 29.
- When the headphone is in use or "DVD MULTI" is selected as the source, the receiver returns to normal operation mode without showing "TEST TONE."
- Do not clap your hands so hard that it may hurt your hands.

Basic setting items

You can adjust the following items. See pages in parentheses for details.

- You cannot select the items which is not available with the current setting.
- The name of the item shown below is the on-screen display indication and the name in parentheses is the display indication.

Items and to do	
SUBWOOFER (SUBWOOFER) Register your subwoofer. (21)	DUAL MONO (DUAL MONO) Select the Dual Mono sound channel. (23)
FRONT SPK (FRONT SPK) Register your front speaker size. (21)	SUBWFR OUT (SUBWFR OUT) Select sounds emitted from the subwoofer. (23)
CENTER SPK (CENTER SPK) Register your center speaker size. (21)	CROSSOVER (CROSSOVER) Select the cutoff frequency to the subwoofer. (23)
SURR. SPK (SURRND SPK) Register your surround speaker size. (21)	LFE ATT (LFE ATT) Attenuate the bass (LFE) sounds. (23)
SURR. BACK SPK (S BACK SPK) Register your surround back speaker size. (21)	MIDNIGHT (MIDNIGHT) Reproduce a powerful sound at night. (24)
DISTANCE UNIT (DIST UNIT) Select the measuring unit for the speaker distance. (22)	DIGITAL IN 1 (DIGITAL IN1) Select the component connected to the digital coaxial terminal—1(DVR/DVD). (24)
FL SPK DISTANCE (FRNT L DIST)* Register the distance from the left front speaker to your listening point. (22)	DIGITAL IN 2 (DIGITAL IN2) Select the component connected to the digital optical terminal—2(VIDEO). (24)
FR SPK DISTANCE (FRNT R DIST)* Register the distance from the right front speaker to your listening point. (22)	DIGITAL IN 3 (DIGITAL IN3) Select the component connected to the digital optical terminal—3(TV). (24)
C SPK DISTANCE (CENTER DIST)* Register the distance from the center speaker to your listening point. (22)	DVD VIDEO (DVD VIDEO) Select the type of video terminal used for the DVD recorder or DVD player. (25)
LS SPK DISTANCE (SURR L DIST)* Register the distance from the left surround speaker to your listening point. (22)	VCR VIDEO (VCR VIDEO) Select the type of video terminal used for the VCR. (25)
RS SPK DISTANCE (SURR R DIST)* Register the distance from the right surround speaker to your listening point. (22)	SUPERIMPOSE (SUPERIMPOSE) Select to superimpose the menus on the TV screen. (25)
SB SPK DISTANCE (S BACK DIST)* Register the distance from the surround back speaker to your listening point. (22)	DOWN MIX (DOWN MIX) Select to convert S-video signals into composite video signals. (25)
EX/ES/PLIIX (EX/ES/PLIIX) Select the EX/ES/PLIIX reproduction mode. (22)	Y/C SEPARATE (Y/C SEP.) Select to convert composite video signals into S-video signals. (25)

* If you have used Smart Surround Setup on pages 16 and 17, these settings are not required.

Operation through on-screen display menus

You can make adjustments to the basic settings easily by using the on-screen display menus.

Menu operation buttons

On the front panel:



Button / JOG	To do
SETTING button	show setting item previously selected.
SET button	move to the selected menu or return to the previous SETTING MENU.
MULTI JOG	<ul style="list-style-type: none"> • select a menu or an item. • change a setting.

From the remote control:

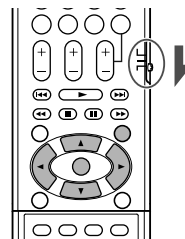

When operating the receiver using the remote control, set the mode selector to "AUDIO/TV/VCR/DBS."

Button	To do
MENU button	show "TOP MENU."
▲ / ▼ buttons	select a menu or an item.
SET button	move to the selected menu or return to the previous SETTING MENU.
◀ / ▶ buttons	change a setting.

Setup menu configuration

- Items on the menus shown below are all set to the initial values when shipping from the factory.
- Some of the menus or some items on the menu cannot be shown or cannot be adjusted depending on the current settings and the connections. (For details, see the respective explanations in this section.)

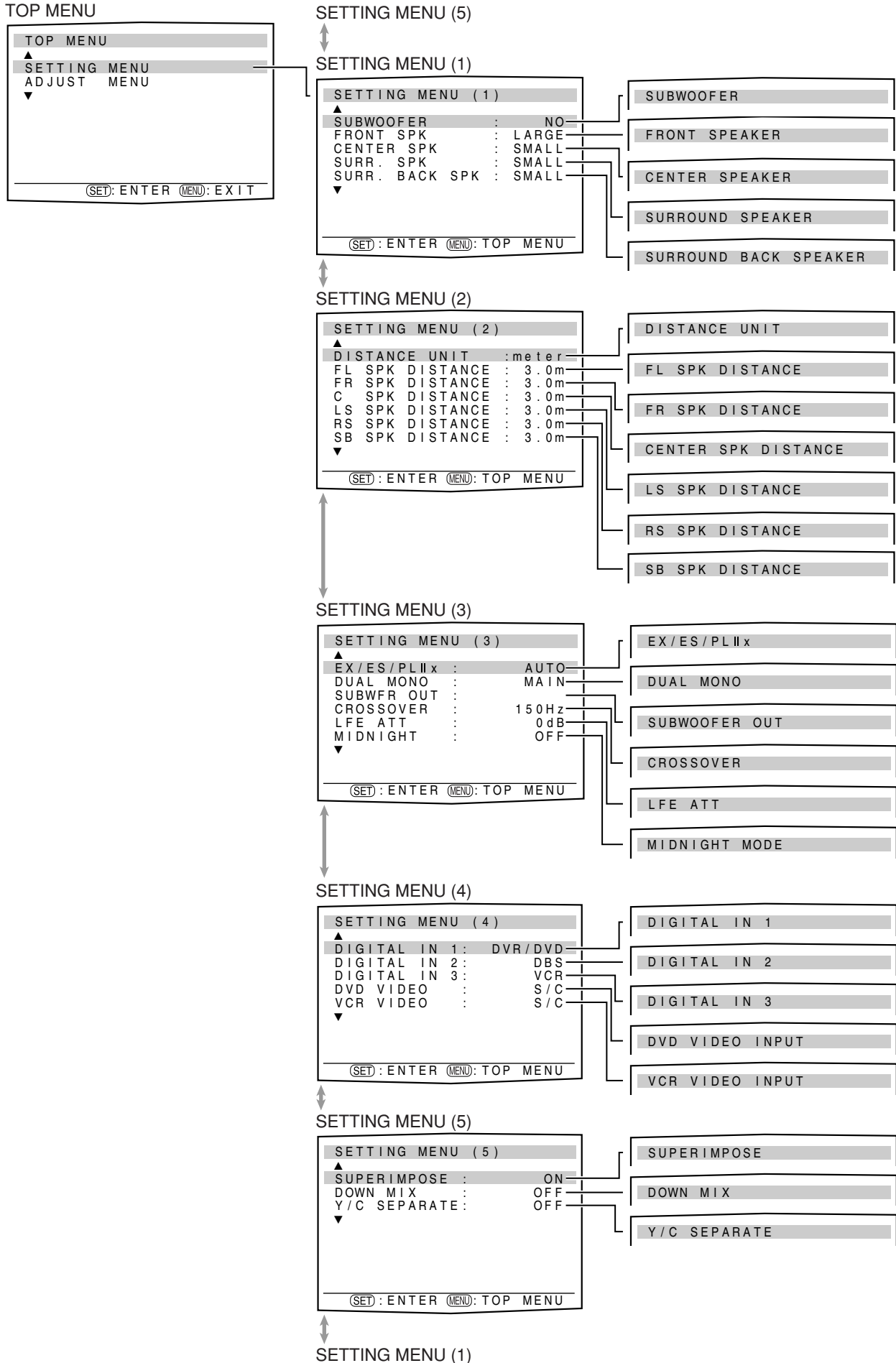

Menu operating procedure

When operating, the on-screen display appears on the TV screen regardless of the SUPERIMPOSE setting (see page 25).

Before you start, remember...

There is a time limit in doing the following steps. If the setting is canceled before you finish, start from step **1** again.

In this section, the operation of the remote control is used for explaining.

Ex.: When setting DIGITAL IN 1 terminal.

Operations

1 To show "TOP MENU," press MENU.

On the TV screen

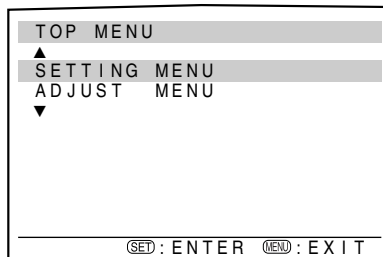

"TOP MENU" appears.

On the display

SETTING

"SETTING" appears.

2 To select "SETTING MENU," press SET.

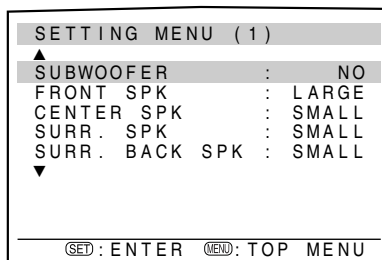

The setting item previously selected appears.

SUBWOOFER

The submenu previously selected appears.

3 To select the desired submenu, press ▲ or ▼ repeatedly.

There are five screens from "SETTING MENU (1)" to "SETTING MENU (5)." To change the screen, simply pressing ▲ or ▼ repeatedly. You can go to the next/previous screen.

- On the front panel, turn MULTI JOG.

Button indications on the screen

The buttons for operating the menu are shown on the TV screen. You can operate the menu with these buttons.

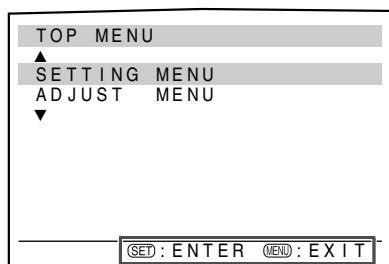

Usable buttons and their functions

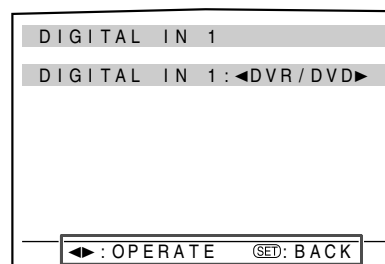

Usable buttons and their functions

4 Press SET.

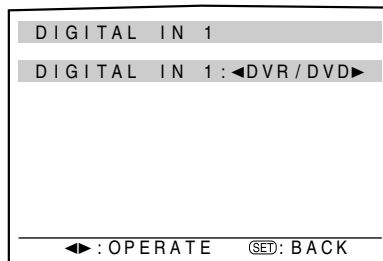

D1 DVR/DVD

The current setting of the selected item appears.

The selected submenu appears.

5 To select the appropriate setting, press ◀ or ▶ repeatedly, then press SET.

The on-screen display returns to the previous SETTING MENU. In this example, "SETTING MENU (4)" appears on the TV screen and "DIGITAL IN1" appears on the display.

- On the front panel, turn MULTI JOG, then press SET.

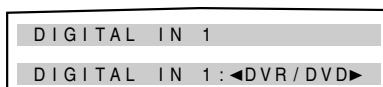

D1 DVR/DVD

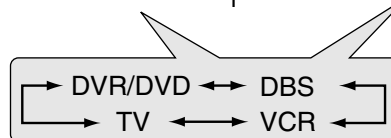

6 Repeat steps 2 to 5 to set other items if necessary.

NOTES

- To return to "TOP MENU," press MENU on the remote control.
- To exit from menu operations, press MENU on the remote control when "TOP MENU" appears. On the front panel, press SETTING when a menu except "TOP MENU" appears.
- The setting item previously selected can be shown on the TV screen by pressing SETTING on the front panel when the receiver is in normal operation mode.

Setting the items

When performing the basic settings viewing the indications on the display, the indications are slightly different from what is shown on the on-screen display.

This is because of the limited number of characters shown on the display.

Ex.: • "SUBWOOFER: YES" is shown as "SUBWFR: YES" on the display.

- "MIDNIGHT MODE: OFF" is shown as "NIGHT: OFF" on the display.

Setting the speakers

■ Setting subwoofer information—SUBWOOFER

Each time the receiver turns on, the receiver detects the subwoofer connection and automatically changes the setting of the subwoofer.

When you want to change the setting manually, select either one below.

SUBWOOFER: YES

Select when you have connected a subwoofer.

The subwoofer indicator (**S.WFR**) lights up on the display. You can adjust the subwoofer output level (see page 29).

SUBWOOFER: NO

Select when you have disconnected a subwoofer. Selecting this changes the front speaker size to "LARGE" (see right column).

NOTE

You need to change the setting each time you turn on the receiver if you want to change the subwoofer information set automatically.

■ Setting the speaker size—FRONT SPEAKER, CENTER SPEAKER, SURROUND SPEAKER, SURROUND BACK SPEAKER

Register the sizes of all the connected speakers.

LARGE	Select when the cone speaker size is larger than 12 cm.
SMALL	Select when the cone speaker size is smaller than 12 cm.
NO	Select when you have disconnected a speaker. (Not selectable for the front speakers.)

Initial setting: SMALL for all speakers*

* When "SUBWOOFER" is set to "SUBWOOFER: NO," the front speaker size is fixed to "LARGE" (and you cannot select "SMALL").

NOTES

- If you have selected "SMALL" for the front speaker size, you cannot select "LARGE" for other speakers.
- When "SURROUND SPEAKER" is set to "SURROUND SPK: SMALL," you cannot select "LARGE" for the surround back speaker.
- When "SURROUND SPEAKER" is set to "SURROUND SPK: NO," the surround back speaker is fixed to "NO."
- If you change one of the speaker sizes either from "NO" to "SMALL" or "LARGE," or from "SMALL" or "LARGE" to "NO," the distance manually set will be applied instead of those set by using Smart Surround Setup.

■ Setting the speaker distance

The distance from your listening point to the speakers is one of the important elements to obtain the best possible sound effect from the Surround/DSP modes.

By referring to the speaker distance, the receiver automatically sets the delay time of the sound through each speaker so that sounds through all the speakers can reach you at the same time.

- If you have used Smart Surround Setup on pages 16 and 17, this setting is not required.

■ Measuring unit—DISTANCE UNIT

Select which measuring unit you use.

DISTANCE UNIT: meter Select to set the distance in meters.

DISTANCE UNIT: feet Select to set the distance in feet.

Initial setting: DISTANCE UNIT: meter

■ Speaker distance—

**FL SPK DISTANCE (for the left front speaker),
FR SPK DISTANCE (for the right front speaker),
CENTER SPK DISTANCE (for the center speaker),
LS SPK DISTANCE (for the left surround speaker),
RS SPK DISTANCE (for the right surround speaker),
SB SPK DISTANCE (for the surround back speaker)**

Adjustable range: 0.3 m to 9.0 m in 0.3 m intervals
(1 ft to 30 ft in 1 ft intervals)

Initial setting: 3.0 m (10 ft) for all speakers

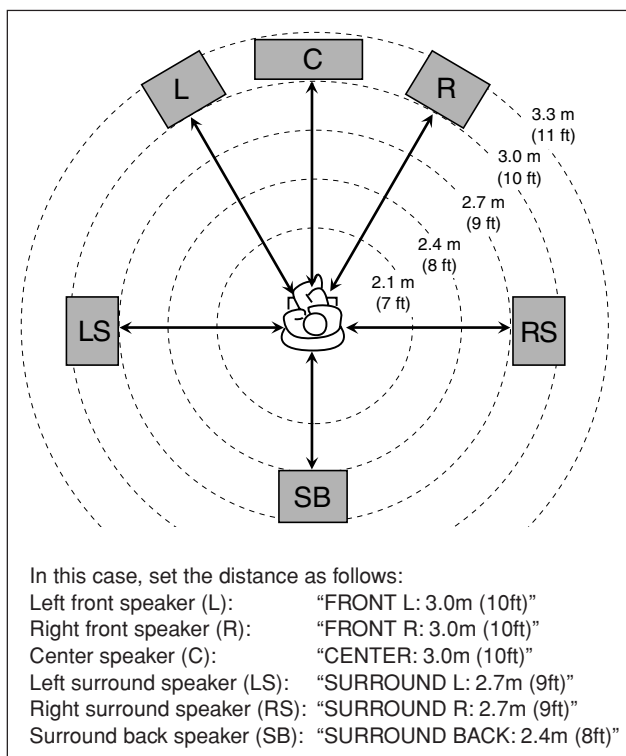

NOTES

- You cannot set the speaker distance for the speakers you have set to "NO."
- If you change one of these settings manually, the distance manually set will be applied instead of those set by using Smart Surround Setup.

Activating the EX/ES/PLIIX setting —EX/ES/PLIIX

Depending on this setting, available Surround modes for digital multi-channel software vary—EX/ES/PLIIX (6.1-channel) reproduction or 5.1-channel reproduction. Select an appropriate setting for your enjoyment.

- For details about relation between EX/ES/PLIIX setting and available Surround mode, see page 38.
- To activate the Surround mode, see page 39.

EX/ES/PLIIX: AUTO

According to the incoming signal, an appropriate Surround mode is applied.

- For Dolby Digital Surround EX and DTS-ES software, 6.1-channel reproduction is applied*.
- For other multi-channel (more than 4 channel) encoded software, 5.1-channel reproduction is applied.

EX/ES/PLIIX: ON

Select to apply 6.1-channel reproduction to both 5.1-channel and 6.1-channel encoded software.

EX/ES/PLIIX: PLIIX MOVIE

Select to apply "PLIIX MOVIE" (6.1-channel) reproduction to both 5.1-channel and 6.1-channel encoded software.

EX/ES/PLIIX: PLIIX MUSIC

Select to apply "PLIIX MUSIC" (6.1-channel) reproduction to both 5.1-channel and 6.1-channel encoded software.

EX/ES/PLIIX: OFF

Select to cancel the EX/ES/PLIIX (6.1-channel) reproduction.

Initial setting: EX/ES/PLIIX: AUTO

- * For some Dolby Digital Surround EX software, Dolby Digital 5.1-channel reproduction ("DOLBY D") may be applied even though you have selected "EX/ES/PLIIX: AUTO." In this case, select "EX/ES/PLIIX: ON" to apply "DOLBY D EX."

From the remote control

You can also make adjustments the following way from the remote control.

Set the mode selector to "AUDIO/TV/VCR/DBS."

Press EX/ES repeatedly to select an appropriate setting for your enjoyment.

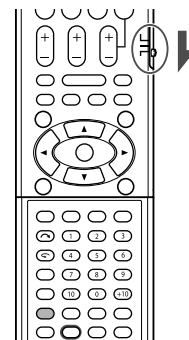

NOTES

- This function is not available in the following cases:
 - When "SURROUND SPEAKER" is set to "SURROUND SPK: NO" (see page 21).
 - When "DVD MULTI" is selected as the source.
- When "SURROUND BACK SPEAKER" is set to "SURR. BACK SPK: NO" (see page 21), the Virtual Surround Back (see page 38) is applied to EX/ES/PLIIX (6.1-channel) reproduction.

Selecting the main or sub channel —DUAL MONO

You can select the playback sound (channel) you want while playing digital software recorded (or broadcasted) in Dual Mono mode (see page 36), which includes two monaural channels separately.

DUAL MONO: MAIN

Select to play back the main channel (Ch 1).*
Signal indicator “L” lights up while playing back this channel.

DUAL MONO: SUB

Select to play back the sub-channel (Ch 2).*
Signal indicator “R” lights up while playing back this channel.

DUAL MONO: ALL

Select to play back both the main and sub-channels (Ch 1/Ch 2).*
Signal indicators “L” and “R” light up while playing back these channels.

Initial setting: DUAL MONO: MAIN

* Dual Mono signals can be heard from the following speakers—L (left front speaker), R (right front speaker), and C (center speaker), with respect to the current Surround setting:

Dual Mono setting	Without Surround		With Surround Activated				
			Center speaker setting				
			SMALL/LARGE			NO	
L	R	L	C	R	L	R	
MAIN	Ch 1	Ch 1	—	Ch 1	—	Ch 1	Ch 1
SUB	Ch 2	Ch 2	—	Ch 2	—	Ch 2	Ch 2
ALL	Ch 1	Ch 2	—	Ch 1+Ch 2	—	Ch 1+Ch 2	Ch 1+Ch 2

NOTE

The Dual Mono format is not identical with bilingual broadcasting for TV programs. So this setting does not take effect while watching such bilingual programs.

Setting bass sound

■ Setting subwoofer output—SUBWOOFER OUT

You can select the type of the signal which can be transmitted through the subwoofer. In other words, you can determine whether or not the bass elements of the front speaker channels are transmitted through the subwoofer regardless of the front speaker size setting (either “SMALL” or “LARGE”).

SUBWFR OUT: LFE

Select to emit only the LFE signals (while playing Dolby Digital and DTS software) or the bass elements of the “SMALL” front speakers (while playing any source other than above).

SUBWFR OUT: LFE+MAIN

Select to always emit the bass elements of the front speaker channels (MAIN). While playing Dolby Digital and DTS software, the bass elements and the LFE signals are both emitted.

Initial setting: SUBWFR OUT: LFE

NOTE

When “SUBWOOFER” is set to “SUBWOOFER: NO” (see page 21), this function is not available.

■ Setting the crossover frequency—CROSSOVER

Small speakers cannot reproduce the bass sounds efficiently. If you use a small speaker in any position, this receiver automatically reallocates the bass sound elements assigned to the small speaker to the large speakers.

To use this function properly, set this crossover frequency level according to the size of the small speaker connected.

- If you have selected “LARGE” for all speakers (see page 21), this function will not take effect (“CROSSOVER: OFF” appears).

CROSSOVER: 80Hz Select when the cone speaker unit built in the speaker is about 12 cm.

CROSSOVER: 100Hz Select when the cone speaker unit built in the speaker is about 10 cm.

CROSSOVER: 120Hz Select when the cone speaker unit built in the speaker is about 8 cm.

CROSSOVER: 150Hz Select when the cone speaker unit built in the speaker is about 6 cm.

CROSSOVER: 200Hz Select when the cone speaker unit built in the speaker is less than 5 cm.

Initial setting: CROSSOVER: 150Hz

NOTE

Crossover frequency is not valid for the HEADPHONE and 3D HEADPHONE modes.

■ Setting the low frequency effect attenuator —LFE ATT

If the bass sound is distorted while playing back software encoded with **Dolby Digital** or **DTS**, set the LFE level to eliminate distortion.

- This function takes effect only when the LFE signals come in.

LFE ATT: 0dB Normally select this.

LFE ATT: -10dB Select when the bass sound is distorted.

Initial setting: LFE ATT: 0dB

Using the Midnight mode —MIDNIGHT MODE

You can enjoy a powerful sound at night using the Midnight mode.

- Once you have made an adjustment, it is memorized for each source.

MIDNIGHT MODE: OFF

Select when you want to enjoy surround with its full dynamic range. (No effect applied.)

MIDNIGHT MODE: 1

Select when you want to reduce the dynamic range a little.

MIDNIGHT MODE: 2

Select when you want to apply the compression effect fully (useful at night).

Initial setting: MIDNIGHT MODE: OFF

From the remote control

You can also make adjustments the following way from the remote control.

Set the mode selector to "AUDIO/TV/VCR/DBS."

Press **SOUND**, then press **MIDNIGHT** repeatedly to select either one of the above.

NOTE

After pressing SOUND, the numeric buttons work for sound adjustments. To use the numeric buttons to operate your target source, press the corresponding source selecting button before operation; otherwise, the remote control may not work as you intend.

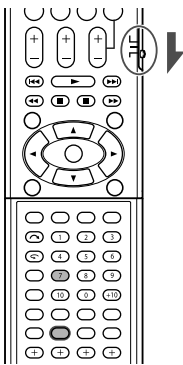

Setting the digital input (DIGITAL IN) terminals—DIGITAL IN 1/2/3

When you use the digital input terminals, register what components are connected to which terminals—DIGITAL IN 1/2/3 (see page 11) so that the correct source name will appear when you select the digital source.

Select one of the following components for each terminal:

DVR/DVD For the DVD player (or DVD recorder).

DBS For the DBS tuner.

VCR For the VCR.

TV For the TV.

Initial setting: DVR/DVD (for "DIGITAL IN 1")
DBS (for "DIGITAL IN 2")
VCR (for "DIGITAL IN 3")

NOTES

- You cannot assign the same component for different terminals. The priority order for assignment is as follows: "DIGITAL IN 1" > "DIGITAL IN 2" > "DIGITAL IN 3." "DIGITAL IN 1" can be set to any component.

Ex.: When "DIGITAL IN 1" is set to "TV,"

DIGITAL IN 1:

"DVR/DVD," "DBS," and "VCR" are selectable for "DIGITAL IN 2."

And when "DIGITAL IN 2" is set to "DVR/DVD,"

DIGITAL IN 1:

DIGITAL IN 2:

"DBS" and "VCR" are selectable for "DIGITAL IN 3."

- Setting "DIGITAL IN 1" affects "DIGITAL IN 2" and "DIGITAL IN 3" settings. When you have changed "DIGITAL IN 1," confirm the components assigned to "DIGITAL IN 2" and "DIGITAL IN 3."

Selecting the component video input mode—DVD VIDEO INPUT/VCR VIDEO INPUT

When you use the component video inputs for connecting the DVD recorder (or DVD player) or VCR, register the type of video input jacks.

If you have not selected appropriate video input jacks, you cannot view the playback picture on the TV or the AV COMPU LINK remote control system cannot operate properly (see page 40).

For the DVD recorder or DVD player (DVD VIDEO):

DVD VIDEO: S/C

Select when connecting the DVD recorder (or DVD player) to the composite video or S-video input jacks.

DVD VIDEO: COMPONENT

Select when connecting the DVD recorder (or DVD player) to the component video input jacks.

Initial setting: DVD VIDEO: S/C

For the VCR (VCR VIDEO):

VCR VIDEO: S/C

Select when connecting the VCR to the composite video or S-video input jacks.

VCR VIDEO: COMPONENT

Select when connecting the VCR to the component video input jacks.

Initial setting: VCR VIDEO: S/C

Superimposing the menus —SUPERIMPOSE

You can select whether or not to superimpose the on-screen display on the TV screen.

SUPERIMPOSE: ON

Select to superimpose the on-screen display on the TV screen.

SUPERIMPOSE: OFF

Select to cancel superimposition. The on-screen display will be shown on the blue background screen.

Initial setting: SUPERIMPOSE: ON

NOTES

- Some on-screen displays appear on the TV screen regardless of this setting.
- The on-screen display does not appear on the TV screen when connecting the TV through the COMPONENT MONITOR OUT jacks (see page 10).

Converting S-video signals into composite video signals—DOWN MIX

You can select whether or not to convert S-video signals into composite video signals.

DOWN MIX: ON Select to convert S-video signals into composite video signals.

DOWN MIX: OFF Select not to use this function.

Initial setting: DOWN MIX: OFF

NOTES

- This function is available when satisfying all the following requirements:
 - When a video component is connected to this receiver through at least one of the S-video input terminals.
 - When a video component or the TV is connected to this receiver through at least one of the composite video output jacks.
 - Either the DVD VIDEO INPUT or VCR VIDEO INPUT is set to “S/C” (see left column).
- When using this function, set the input mode of the TV correctly. (Refer also to the manual supplied with the TV.)

Converting composite video signals into S-video signals—Y/C SEPARATE

You can select whether or not to convert composite video signals come from a video component into S-video signals.

Y/C SEPARATE: ON Select to convert composite video signals into S-video signals.

Y/C SEPARATE: OFF Select not to use this function.

Initial setting: Y/C SEPARATE: OFF

NOTES

- This function is available when satisfying all the following requirements:
 - When a video component is connected to this receiver through at least one of the composite video input jacks.
 - When a video component or the TV is connected to this receiver through at least one of the S-video output terminals.
 - Either the DVD VIDEO INPUT or VCR VIDEO INPUT is set to “S/C” (see left column).
- When using this function, set the input mode of the TV correctly. (Refer also to the manual supplied with the TV.)

Sound adjustments

You can make sound adjustment to your preference after completing basic setting.

Basic adjustment items

You can adjust the following items. See pages in parentheses for details.

- You cannot select the items which is not available with the current setting.
- The name of the item shown below is the on-screen display indication and the name in parentheses is the display indication.

Items and to do	
SUBWOOFER LEVEL (SUBWFR LVL) Adjust the subwoofer output level. (29)	BASS BOOST (BASS BOOST) Boost the bass level. (30)
FRONT L LEVEL (FRONT L LVL) Adjust the left front speaker output level. (29)	SUBWFR PHASE (SBWFR PHASE) Select the subwoofer sound phase. (30)
FRONT R LEVEL (FRONT R LVL) Adjust the right front speaker output level. (29)	INPUT ATT (INPUT ATT) Attenuate the input level of analog source. (30)
CENTER LEVEL (CENTER LVL) Adjust the center speaker output level. (29)	EFFECT (EFFECT) Adjust the effect level. (31)
SURR. L LEVEL (SURR L LVL) Adjust the left surround speaker output level. (29)	PANORAMA (PANORAMA) Add wraparound sound effect with side-wall image. (31)
SURR. R LEVEL (SURR R LVL) Adjust the right surround speaker output level. (29)	CENTER GAIN (CENTER GAIN) Adjust the sound localization of the center channel. (31)
SURR. BACK LEVEL (S BACK LVL) Adjust the surround back speaker output level. (29)	CENTER TONE (CENTER TONE) Make the center tone soft or sharp. (31)
DIGITAL EQ 63Hz (D EQ 63Hz)* DIGITAL EQ 250Hz (D EQ 250Hz)* DIGITAL EQ 1kHz (D EQ 1kHz)* DIGITAL EQ 4kHz (D EQ 4kHz)* DIGITAL EQ 16kHz (D EQ 16kHz)* Adjust the equalization pattern of each band. (30)	CNTR ALIGNMENT (CNTR ALIGN) Align the vertical localization of the center channel. (31)

* If you have used Smart Surround Setup on pages 16 and 17, these settings are not required.

Operation through on-screen display menus

You can make adjustments to the basic settings easily by using the on-screen display menus.

Menu operation buttons

On the front panel:

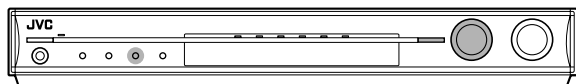

Button / JOG	To do
ADJUST button	show adjustment item previously selected.
SET button	move to the selected menu or return to the previous ADJUST MENU.
MULTI JOG	<ul style="list-style-type: none"> • select a menu or an item. • change a setting.

From the remote control:

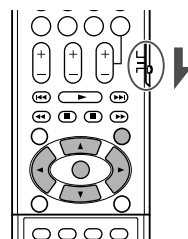

When operating the receiver using the remote control, set the mode selector to "AUDIO/TV/VCR/DBS."

Button	To do
MENU button	show "TOP MENU."
▲ / ▼ buttons	select a menu or an item.
SET button	move to the selected menu or return to the previous ADJUST MENU.
◀ / ▶ buttons	change a setting.

Setup menu configuration

- Items on the menus shown below are all set to the initial values when shipping from the factory.
- Some of the menus or some items on the menu cannot be shown or cannot be adjusted depending on the current settings and the connections. (For details, see the respective explanations in this section.)
- The "ADJUST MENU (3)" screen cannot be shown depending on the current settings and the connections.

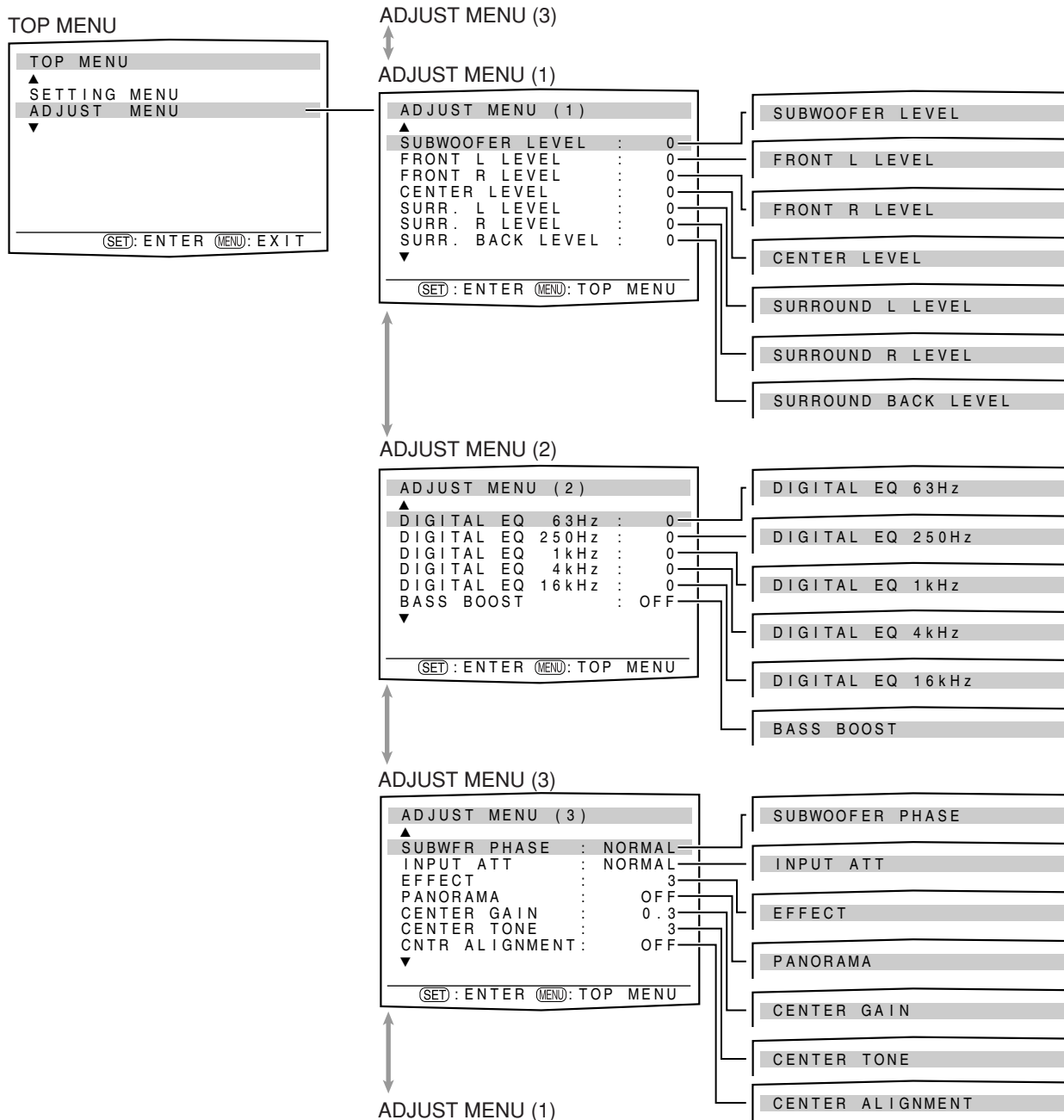

Menu operating procedure

When operating, the on-screen display appears on the TV screen regardless of the SUPERIMPOSE setting (see page 25).

Before you start, remember...



There is a time limit in doing the following steps. If the setting is canceled before you finish, start from step **1** again.

In this section, the operation of the remote control is used for explaining.

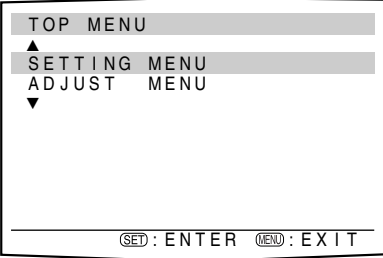
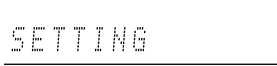
Ex.: When adjusting subwoofer output level.

Operations	On the TV screen	On the display
<p>1 To show “TOP MENU,” press MENU. Then press ▲ or ▼ to select “ADJUST MENU.”</p> <ul style="list-style-type: none"> On the front panel, turn MULTI JOG. 	 <p>“TOP MENU” appears.</p>	 <p>“SETTING” appears.</p>

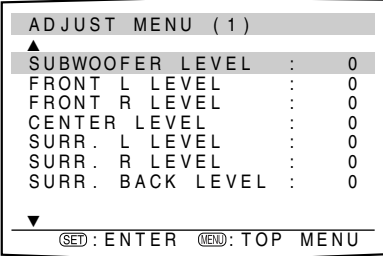
2 To select “ADJUST MENU,” press SET.



 <p>The adjustment item previously selected appears.</p>	 <p>The submenu previously selected appears.</p>
---	---

3 To select the desired submenu, press ▲ or ▼ repeatedly.

There are three screens from “ADJUST MENU (1)” to “ADJUST MENU (3).” To change the screen, simply pressing ▲ or ▼ repeatedly. You can go to the next/previous screen.

- On the front panel, turn MULTI JOG.

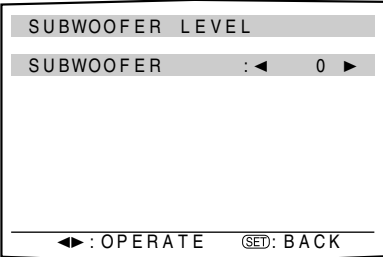

4 Press SET.

 <p>The selected submenu appears.</p>	 <p>The current setting of the selected item appears.</p>
---	--

5 To adjust the selected item, press ◀ or ▶ repeatedly, then press SET.

The on-screen display returns to the previous ADJUST MENU. In this example, “ADJUST MENU (1)” appears on the TV screen and “SUBWFR LVL” appears on the display.

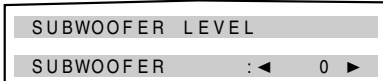
- On the front panel, turn MULTI JOG, then press SET.

	
--	---

-10 ◀---▶ 0 ◀---▶ +10

6 Repeat steps 2 to 5 to set other items if necessary.

NOTES

- To return to "TOP MENU," press MENU on the remote control.
- To exit from menu operations, press MENU on the remote control when "TOP MENU" appears. On the front panel, press ADJUST when a menu except "TOP MENU" appears.
- The adjustment item previously selected can be shown on the TV screen by pressing ADJUST on the front panel when the receiver is in normal operation mode.

Button indications on the screen

The buttons for operating the menu are shown on the TV screen. You can operate the menu with these buttons.

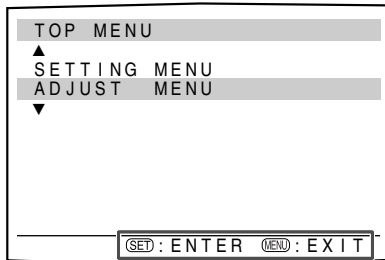

Usable buttons and their functions

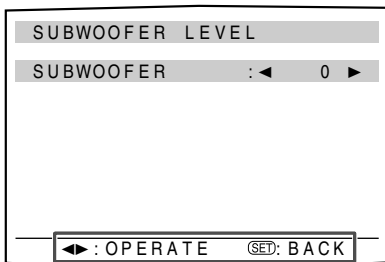

Usable buttons and their functions

Adjusting the items

When performing the basic settings viewing the indications on the display, the indications are slightly different from what is shown on the on-screen display.

This is because of the limited number of characters shown on the display.

- Ex.:
- "SUBWOOFER: +10" is shown as "SUBWFR +10" on the display.
 - "BASS BOOST: ON" is shown as "B BOOST ON" on the display.

Adjusting speaker output level

- **SUBWOOFER LEVEL** (subwoofer output level),
- **FRONT L LEVEL** (left front speaker output level),
- **FRONT R LEVEL** (right front speaker output level),
- **CENTER LEVEL** (center speaker output level),
- **SURROUND L LEVEL** (left surround speaker output level),
- **SURROUND R LEVEL** (right surround speaker output level),
- **SURROUND BACK LEVEL** (surround back speaker output level)

You can adjust the speaker output levels.

Adjust all the speakers' output levels so that you can listen to the sounds from all the speakers at the same level.

- Once you have made an adjustment, it is memorized for each source.

Adjustable range: -10 (dB) to +10 (dB) (in 1 step intervals)

Initial setting: 0 (dB) for all speakers

NOTES

- If you have selected "NO" for a speaker (see page 21), the output level for the corresponding speaker is not adjustable.
- While using the headphones, you can adjust only the left and right front speakers' output level.

From the remote control:

You can also make adjustments the following way from the remote control.

Set the mode selector to "AUDIO/TV/VCR/DBS."

**1 Press TEST TONE to check the speakers' output balance.**

- On the TV screen, "TEST TONE" appears. The » indicator corresponding to the speaker appears while a test tone comes out of the speakers.

EX.:

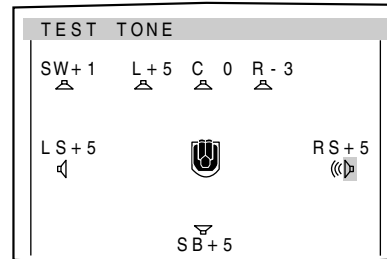

- On the display, "TEST L" starts flashing, and a test tone comes out of the speakers in the following order:

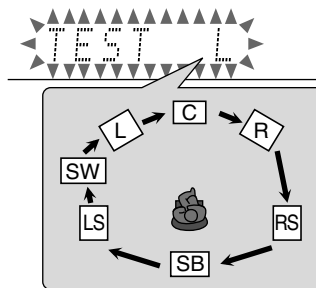
**2 Adjust the speaker output levels.**

To adjust the left front speaker level (L), press FRONT L +/-.

To adjust the right front speaker level (R), press FRONT R +/-.

To adjust the center speaker level (C), press CENTER +/-.

To adjust the left surround speaker level (LS), press SURR L +/-.

To adjust the right surround speaker level (RS), press SURR R +/-.

To adjust the surround back speaker level (SB), press S.BACK +/-.

To adjust the subwoofer level (SW), press SUBWFR +/-.

3 Press TEST TONE again to stop the test tone.**NOTES**

- You can adjust the speaker output levels without the test tone.
- No test tone comes out of the speakers and no speaker indication appears on the TV screen corresponding to the speaker which is set to "NO" in the speaker setting (see page 21).
- No test tone is available when the headphone is in use or "DVD MULTI" is selected.

Adjusting the equalization patterns —DIGITAL EQ 63Hz/250Hz/1kHz/4kHz/16kHz

You can adjust equalization patterns in five frequency bands (center frequency: 63 Hz, 250 Hz, 1 kHz, 4 kHz, 16 kHz) for the front speakers.

- Once you have made an adjustment, it is memorized for each source.

Adjustable range: -8 (dB) to +8 (dB) (in 2 dB intervals)

Initial setting: 0 (dB) for all bands

- When adjustment is made, the EQ indicator lights up on the display.

If no adjustment is required, set all the frequency bands to "0 (dB)."

- The EQ indicator goes off from the display.

From the remote control:

You can also make adjustments the following way from the remote control.

Before you start, remember...

There is a time limit in doing the following steps. If the setting is canceled before you finish, start from step **2** again.

Set the mode selector to "AUDIO/TV/VCR/DBS."

- Press **SOUND**.
- Press **EQ FREQ** repeatedly to select the band you want to adjust.
- Press **EQ LEVEL** \oplus/\ominus to adjust the equalization pattern of the selected band.
- Repeat steps **2** and **3** to adjust other bands.

NOTE

After pressing **SOUND**, the numeric buttons work for sound adjustments. To use the numeric buttons to operate your target source, press the corresponding source selecting button before operation; otherwise, the remote control may not work as you intend.

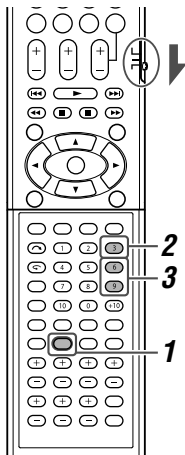

Adjusting the bass sounds

■ Reinforcing the bass—BASS BOOST

You can boost the bass level—Bass Boost.

- Once you have made an adjustment, it is memorized for each source.

BASS BOOST: ON Select to boost the bass level.
The BASS indicator lights up on the display.

BASS BOOST: OFF Select to deactivate the Bass Boost.

Initial setting: BASS BOOST: OFF

NOTE

This function affects only the sound coming out through the front speakers.

From the remote control:

You can also make adjustments the following way from the remote control.

Set the mode selector to "AUDIO/TV/VCR/DBS."

Press SOUND, then press BASS BOOST repeatedly.

- Each time you press **BASS BOOST**, the Bass Boost turns on and off alternately.

NOTE

After pressing **SOUND**, the numeric buttons work for sound adjustments. To use the numeric buttons to operate your target source, press the corresponding source selecting button before operation; otherwise, the remote control may not work as you intend.

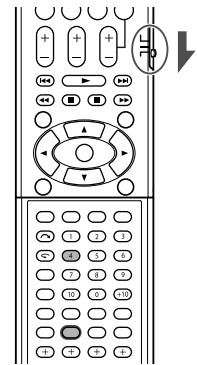

■ Selecting the subwoofer sound phase— SUBWOOFER PHASE

You can change the subwoofer sound phase to your preference.

- Once you have made an adjustment, it is memorized for each source.

PHASE: NORMAL Normally select this.

PHASE: REVERSE Select this when you feel the bass sound is better with this mode rather than with "PHASE: NORMAL."

Initial setting: PHASE: NORMAL

NOTE

This function takes effect only when "SUBWOOFER" is set to "SUBWOOFER: YES" (see page 21).

■ Attenuating the input signal—INPUT ATT

When the input level of **analog source** is too high, the sound will be distorted. If this happens, you need to attenuate the input signal level to prevent the sound distortion.

- Once you have made an adjustment, it is memorized for each source.

INPUT ATT: ON Select to attenuate the input signal level.
The ATT indicator lights up on the display.

INPUT ATT: NORMAL Select to deactivate attenuation.

Initial setting: INPUT ATT: NORMAL

Adjusting the sound parameters for the Surround/DSP modes

You can adjust the Surround/DSP sound parameters to your preference.

- For details about the Surround/DSP modes, see pages 34 to 39.

■ Adjusting the effect level for DSP modes —EFFECT

This setting is available only when one of the DSP modes (except ALL CH ST) is in use. To activate DSP mode, see page 39.

- Once you have made an adjustment, it is memorized for each DSP mode.

Adjustable range: 1 to 5 (in 1 step intervals)

Initial setting: EFFECT: 3

As the number increases, the effect becomes stronger. Normally, select "3."

From the remote control:

You can also make adjustments the following way from the remote control.

Set the mode selector to "AUDIO/TV/VCR/DBS."

Press **SOUND**, then press **EFFECT** repeatedly.

NOTE

After pressing **SOUND**, the numeric buttons work for sound adjustments. To use the numeric buttons to operate your target source, press the corresponding source selecting button before operation; otherwise, the remote control may not work as you intend.

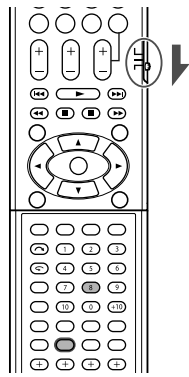

■ Adjusting the panorama control for Pro Logic II Music—PANORAMA

This setting is available only when Pro Logic II Music is in use. To activate Pro Logic II Music, see page 39.

- Once you have made an adjustment, it is memorized until you change the setting.

PANORAMA: ON Select to add "wraparound" sound effect with side-wall image.

PANORAMA: OFF Select to listen to originally recorded sound.

Initial setting: PANORAMA: OFF

■ Adjusting the sound localization of the center channel—CENTER GAIN

This setting is available only when Neo:6 Music is in use.

- If you have set "CENTER SPEAKER" to "CENTER SPK: NO" (see page 21), the center gain is not adjustable.
- Once you have made an adjustment, it is memorized until you change the setting.

Adjustable range: 0 to 1.0 (in 0.1 step intervals)

Initial setting: CENTER GAIN: 0.3

As the number increases, the center channel will be localized clearly.

Normally, select "0.3."

■ Making the center tone soft or sharp —CENTER TONE

This setting is available when one of the Surround/DSP modes is in use. To activate Surround/DSP mode, see page 39.

- This setting is common to all Surround modes, and is memorized separately for DSP modes.
- You cannot adjust the center tone in the following cases:
 - When "CENTER SPEAKER" is set to "CENTER SPK: NO" (see page 21).
 - When Dual Mono software is played back.
 - While listening with the headphones.

Adjustable range: 1 to 5 (in 1 step intervals)

Initial setting: CENTER TONE: 3

As the number increases, the dialogue becomes stronger.

Normally, select "3."

- When the center tone is set to other than "CENTER TONE: 3," the C.TONE indicator lights up on the display.

From the remote control:

You can also make adjustments the following way from the remote control.

Set the mode selector to "AUDIO/TV/VCR/DBS."

Press **SOUND**, then press **C.TONE** repeatedly.

NOTE

After pressing **SOUND**, the numeric buttons work for sound adjustments. To use the numeric buttons to operate your target source, press the corresponding source selecting button before operation; otherwise, the remote control may not work as you intend.

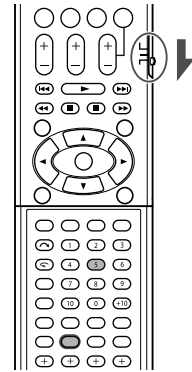

■ Align the vertical localization of the center channel —CENTER ALIGNMENT

This setting is available when one of the Surround/DSP modes (except "PLII MUSIC," "PLIIX MUSIC," "Neo:6 MUSIC," and "ALL CH ST") is in use. To activate Surround/DSP mode, see page 39.

- Once you have made an adjustment, it is memorized for each Surround/DSP mode.
- You cannot adjust the center alignment in the following cases:
 - When "CENTER SPEAKER" is set to "CENTER SPK: NO" (see page 21).
 - When Dual Mono software is played back.
 - While listening with the headphones.

C ALIGNMENT: ON Select when you cannot feel as if the actors or singers are speaking or singing on the screen.

C ALIGNMENT: OFF Select not to use this function.

Initial setting: C ALIGNMENT: OFF

Tuner operations

Tuner operations are mainly done from the remote control.

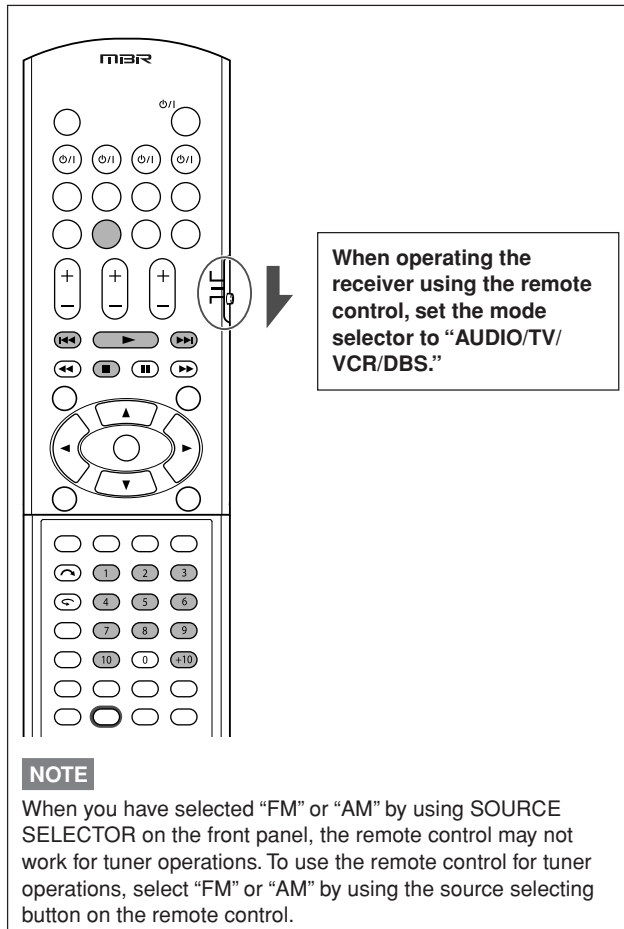

Setting the AM tuner interval spacing

Some countries space AM stations 9 kHz apart, and other countries use 10 kHz spacing. 9 kHz interval spacing is the initial setting.

- Be sure the receiver is turned off, but is plugged into an AC outlet when setting the AM tuner interval.

On the front panel ONLY:

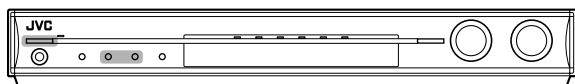

To select the 10 kHz interval:

Hold down ADJUST and press ϕ/I STANDBY/ON. "10k STEP" appears on the display.

To change back to the 9 kHz interval:

Hold down SETTING and press ϕ/I STANDBY/ON. "9k STEP" appears on the display.

NOTE

When you change the AM tuner interval spacing, stored preset stations are erased. In this case, restore stations.

Tuning in to stations manually

From the remote control ONLY:

1 Press FM/AM to select the band.

- The last received station of the selected band is tuned in.
- Each time you press the button, the band alternates between "FM" and "AM."

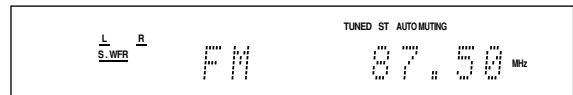

2 Press repeatedly or hold TUNING \oplus or \ominus TUNING until the station you want is tuned in.

- Pressing (or holding) TUNING \oplus increases the frequency.
- Pressing (or holding) TUNING \ominus decreases the frequency.

NOTES

- When you hold and release TUNING \oplus or \ominus TUNING, the frequency keeps changing until a station is tuned in.
- When a station of sufficient signal strength is tuned in, the TUNED indicator lights up on the display.
- When an FM stereo program is received, the ST (stereo) indicator also lights up.

Using preset tuning

Once a station is assigned a channel number, the station can be quickly tuned simply by selecting the number. You can preset up to 30 FM and 15 AM stations.

To store the preset stations

Before you start, remember...

There is a time limit in doing the following steps. If the setting is canceled before you finish, start from step 2 again.

From the remote control ONLY:

1 Tune in to the station you want to preset (see "Tuning in to stations manually" above).

- If you want to store the FM reception mode for this station, select the FM reception mode you want. See "Selecting the FM reception mode" on page 33.

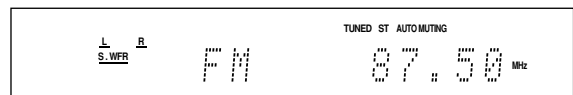

2 Press MEMORY.

The channel number position starts flashing on the display for about 5 seconds.



3 Press the numeric buttons (1 – 10, +10) to select a channel number while the channel number position is flashing.

- For channel number 5, press 5.
- For channel number 15, press +10, then 5.
- For channel number 30, press +10, +10, then 10.

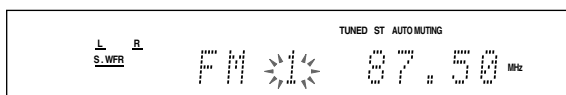

4 Press MEMORY again while the selected channel number is flashing on the display.

The selected channel number stops flashing.
The station is assigned to the selected channel number.

5 Repeat steps 1 to 4 until you store all the stations you want.

To erase a stored preset station

Storing a new station on a used channel number erases the previously stored one.

To tune in a preset station

From the remote control:

1 Press FM/AM to select the band.

The last received station of the selected band is tuned in and the numeric buttons now work for tuner operations.

- Each time you press the button, the band alternates between "FM" and "AM."

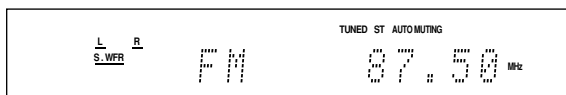

2 Press the numeric buttons (1 – 10, +10) to select a preset channel number.

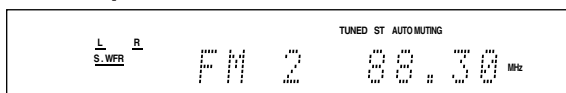

- For channel number 5, press 5.
- For channel number 15, press +10, then 5.
- For channel number 30, press +10, +10, then 10.

On the front panel:



Before you start, remember...

There is a time limit in doing the following steps. If the setting is canceled before you finish, start from step 2 again.

1 Turn SOURCE SELECTOR to select "FM" or "AM."

The last received station of the selected band is tuned in.

2 Press TUNER PRESET.

"P" appears on the display and MULTI JOG now works for selecting preset channels.

3 Turn MULTI JOG to select a preset channel number while "P" appears on the display.

- To increase the preset channel numbers, turn MULTI JOG clockwise.
- To decrease the preset channel numbers, turn MULTI JOG counterclockwise.

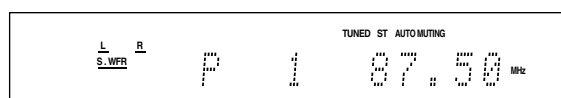

Selecting the FM reception mode

When an FM stereo broadcast is hard to receive or noisy, you can change the FM reception mode while receiving an FM broadcast.

- You can store the FM reception mode for each preset station (see page 32).

From the remote control ONLY:

While listening to an FM station, press FM MODE.

- Each time you press the button, the FM reception mode alternates between "AUTO MUTING" and "MONO."

AUTO MUTING

Normally select this.
When a program is broadcast in stereo, you will hear stereo sound; when in monaural, you will hear monaural sound. This mode is also useful to suppress static noise between stations. The AUTO MUTING indicator lights up on the display.

MONO

Select this to improve the reception (but stereo effect will be lost).
In this mode, you will hear noise while tuning in to the stations. The AUTO MUTING indicator goes off from the display. (The ST indicator also goes off.)

Initial setting: AUTO MUTING

Creating realistic sound fields

Reproducing theater ambience

In a movie theater, many speakers are located on the walls to reproduce impressive multi-channel sound, reaching you from all directions.

With these many speakers, sound localization and sound movement can be expressed.

Surround/DSP modes built in this receiver can create almost the same Surround sound as you can feel in a real movie theater.

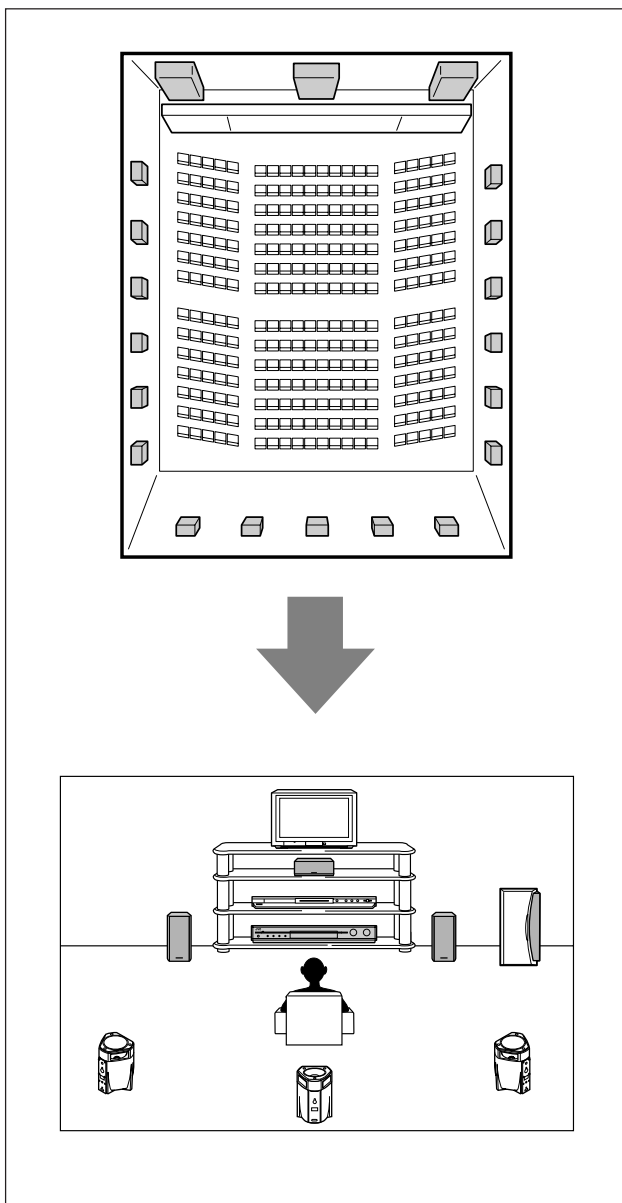

Introducing the Surround modes

■ Dolby Digital*

Dolby Digital is a digital signal compression method, developed by Dolby Laboratories, and enables multi-channel encoding and decoding.

- When Dolby Digital signal is detected through the digital input, the **DOLBY D** indicator lights up on the display.

Dolby Digital 5.1CH

Dolby Digital 5.1CH (DOLBY D) encoding method records and digitally compresses the left front channel, right front channel, center channel, left surround channel, right surround channel, and LFE channel signals (total 6 channels, but the LFE channel is counted as 0.1 channel. Therefore, called 5.1 channel).

Dolby Digital enables stereo surround sounds, and sets the cutoff frequency of the surround treble at 20 kHz, compared to 7 kHz for Dolby Pro Logic. As such, the sound movement and “being-there” feeling are enhanced much more than Dolby Pro Logic.

Dolby Digital EX

Dolby Digital EX (DOLBY D EX) is a digital surround encoding format that adds the third surround channels, called “surround back.”

Compared to the conventional Dolby Digital 5.1CH, these newly added surround back channels can reproduce more detailed movements behind you while viewing the video software. In addition, surround sound localization will become more stable.

■ Dolby Surround

Dolby Pro Logic II

Dolby Pro Logic II is a multi-channel playback format to convert 2-channel software into 5-channel (plus subwoofer). The matrix-based conversion method used for Dolby Pro Logic II makes no limitation for the cutoff frequency of the surround treble and enables stereo surround sound.

- This receiver provides two types of Dolby Pro Logic II modes—**Pro Logic II Movie** (PLII MOVIE) and **Pro Logic II Music** (PLII MUSIC).

When Dolby Pro Logic II is activated, the  **PL II** indicator lights up on the display.

PLII MOVIE Suitable for playing any Dolby Surround encoded software. You can enjoy a sound field very close to the one created with discrete 5.1-channel sounds.

PLII MUSIC Suitable for playing any 2-channel stereo software. You can enjoy wide and deep sounds.

Dolby Pro Logic IIx

Dolby Pro Logic IIx is a newly introduced multi-channel playback format to convert not only multi-channel software but 2-channel software into 6.1 channel (or 7.1 channel) that developed from Dolby Pro Logic II. The matrix-based conversion method used for Dolby Pro Logic IIx makes no limitation for the cutoff frequency of the surround treble.

- This receiver provides two types of Dolby Pro Logic IIx modes—**Pro Logic IIx Movie** (PLIIx MOVIE) and **Pro Logic IIx Music** (PLIIx MUSIC).

When Dolby Pro Logic IIx is activated, the  **PL IIx** indicator lights up on the display.

PLIIx MOVIE Suitable for playing any Dolby Surround encoded software. You can enjoy a sound field with a natural wraparound effect.

PLIIx MUSIC Suitable for playing any 2-channel stereo software. You can enjoy wide and deep 6.1-channel sounds.

- To enjoy software encoded with Dolby Digital, connect the source component using the digital terminal on the rear of this receiver. (See page 11.)

* Manufactured under license from Dolby Laboratories. “Dolby”, “Pro Logic”, and the double-D symbol are trademarks of Dolby Laboratories.

■ DTS**

DTS is another digital signal compression method, developed by Digital Theater Systems, Inc., and enables multi-channel encoding and decoding (1ch up to 6.1ch).

- When DTS signal is detected through the digital input, the **DTS** indicator lights up on the display.

DTS Digital Surround

DTS Digital Surround (DTS) is another discrete 5.1 channel digital audio format available on CD, LD, and DVD software. Compared to Dolby Digital, the DTS Digital Surround format has a lower audio compression rate which enables it to add breadth and depth to the sounds reproduced. As such, DTS Digital Surround features natural, solid, and clear sound.

DTS Extended Surround (DTS-ES)

DTS-ES is another multi-channel digital encoding format. It greatly improves the 360-degree surround impression and space expression by adding the third surround channel—surround back channel.

DTS-ES includes two signal formats with different surround signal recording methods—**DTS-ES Discrete 6.1ch** (ES DISCRETE) and **DTS-ES Matrix 6.1ch** (ES MATRIX).

DTS-ES Discrete 6.1ch has been designed to encode (and decode) a 6.1-channel signal discretely to avoid interference with each channel.

DTS-ES Matrix 6.1ch has been designed to add an extra surround channel to DTS Digital Surround 5.1-channel. By using a matrix encoding/decoding method, an additional “surround back” channel signal is encoded (and decoded) in both the left and right surround channel signals.

** “DTS”, “DTS-ES”, “Neo:6” and “DTS 96/24” are trademarks of Digital Theater Systems, Inc.

DTS 96/24

In recent years, there has been increasing interest in higher sampling rates both for recording and for reproducing at home. Higher sampling rates allow wider frequency range and greater bit depths provide extended dynamic range.

DTS 96/24 is a multi-channel digital signal format (fs 96 kHz/24 bits) introduced by Digital Theater Systems, Inc. to deliver "better-than-CD sound quality" into the home.

- When DTS 96/24 signal is detected, the **DTS** and **96/24** indicators light up. You can enjoy its 5.1-channel sound with full-quality.

DTS Neo:6

DTS Neo:6 is another conversion method to create 6-channel (plus subwoofer) from analog/digital 2-channel software by using the high precision digital matrix decoder used for DTS-ES Matrix 6.1ch.

- This receiver provides the following DTS Neo:6 modes—**Neo:6 Cinema** (NEO:6CINEMA) and **Neo:6 Music** (NEO:6 MUSIC). When one of them is activated, the **NEO:6** indicator lights up on the display.

NEO:6CINEMA Suitable for playing movies. You can get the same atmosphere with 2-channel software as with 6.1-channel software. It is also effective for playing software encoded with conventional surround formats.

NEO:6 MUSIC Suitable for playing music software. The front channel signals bypass the decoder (resulting in no loss of sound quality) and the surround signals transmitted through the other speakers expand the sound field naturally.

When using Surround mode, the sounds come out of the activated speakers which the Surround mode requires.

- **If either the surround speakers or center speaker is set to "NO" in the speaker setting (see page 21),** the corresponding channel signals are allocated to and emitted through the front speakers.
- **If both the surround speakers and center speaker are set to "NO" in the speaker setting (see page 21),** JVC's original 3D-PHONIC processing (which has been developed to create the surround effect through the front speakers only) is used. The 3D indicator lights up on the display.

3D HEADPHONE mode

If you connect a pair of headphones while one of the Surround modes is in use, the 3D HEADPHONE mode is activated without respect to the type of software played back. "3DHEADPHONE" appears on the display and the DSP, 3D, and HP indicators light up.

About other digital signals**Linear PCM**

Uncompressed digital audio data used for DVDs, CDs, and Video CDs.

DVDs support 2 channels with sampling rates of 48/96 kHz, at quantization of 16/20/24 bits. On the other hand, CDs and Video CDs are limited to 2 channels with 44.1 kHz at 16 bits.

- When Linear PCM signal is detected, the LPCM indicator lights up.

Dual Mono

Dual Mono can be easily understood when you think of the bilingual broadcast for TV programs (however, the Dual Mono format is not identical with those analog formats).

This format is now adopted in Dolby Digital, DTS, and so on. It allows two independent channels (called main channel and sub-channel) to be recorded separately.

- You can select either channel you want to listen to (see page 23).

Introducing the DSP modes

The sound heard in a concert hall, club, etc. consists of direct sound and indirect sound—early reflections and reflections from behind. Direct sounds reach the listener directly without any reflection. On the other hand, indirect sounds are delayed by the distances of the ceiling and walls. These direct sounds and indirect sounds are the most important elements of the acoustic surround effects.

The DSP (Digital Signal Processor) modes can create these important elements, and give you a real “being there” feeling.

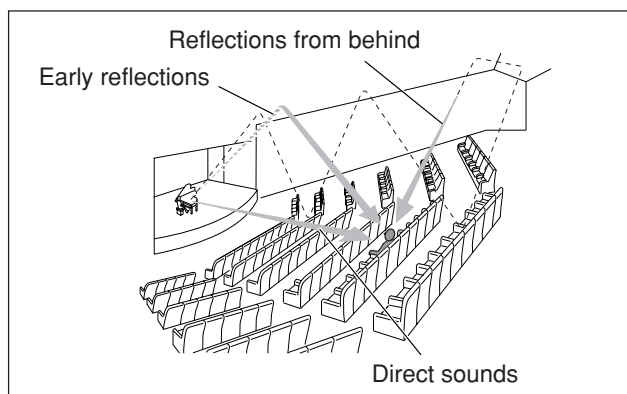

The DSP modes include the following modes:

- Digital Acoustic Processor (DAP) modes—HALL1, HALL2, LIVE CLUB, DANCE CLUB, PAVILION, THEATER1, THEATER2
- MONO FILM—Used for all types of 2-channel signals (including Dual Mono signal)
- All Channel Stereo mode (ALL CH ST)

When one of the DSP modes is activated, the DSP indicator lights up on the display.

Digital Acoustic Processor (DAP) modes

You can use the following DAP modes in order to reproduce a more acoustic sound field in your listening room.

HALL1	Reproduces the spatial feeling of a large shoebox-shaped hall designed primarily for classical concerts. (Its seating capacity is about 2000.)
HALL2	Reproduces the spatial feeling of a large vineyard-shaped hall designed primarily for classical concerts. (Its seating capacity is about 2000.)
LIVE CLUB	Reproduces the spatial feeling of a live music club with a low ceiling.
DANCE CLUB	Reproduces the spatial feeling of a rocking dance club.
PAVILION	Reproduces the spatial feeling of an exhibition hall with a high ceiling.
THEATER1	Reproduces the spatial feeling of a large theater where the seating capacity is about 600.
THEATER2	Reproduces the spatial feeling of a small theater where the seating capacity is about 300.

NOTE

When “THEATER1” or “THEATER2” is activated while playing back 2-channel analog or digital source, the built-in Dolby Pro Logic II decoder is activated and the PL II indicator lights up.

When using the DAP mode, the sounds come out of all the connected and activated speakers.

- If the surround speakers are set to “NO” in the speaker setting (see page 21), JVC’s original 3D-PHONIC processing (which has been developed to create the surround effect through the front speakers only) is used. The 3D indicator lights up on the display.

MONO FILM

In order to reproduce a more acoustic sound field in your listening room while viewing monaural sound video software (analog and 2-channel digital signals including Dual Mono signal), you can use this mode.

The surround effect will be added, and the sound localization of actor’s words will be improved.

This mode cannot be used for multi-channel digital signals.

When “MONO FILM” is used, sounds come out of all the connected (and activated) speakers.

- If the surround speakers are set to “NO” in the speaker setting (see page 21), JVC’s original 3D-PHONIC processing (which has been developed to create the surround effect through the front speakers only) is used. The 3D indicator lights up on the display.
- If incoming signals change from 2-channel digital signal to another digital signal type, “MONO FILM” is canceled and an appropriate Surround mode is activated.

All Channel Stereo mode (ALL CH ST)

This mode can reproduce a larger stereo sound field using all the connected (and activated) speakers.

This mode cannot be used if the surround speakers are set to “NO” in the speaker setting (see page 21).

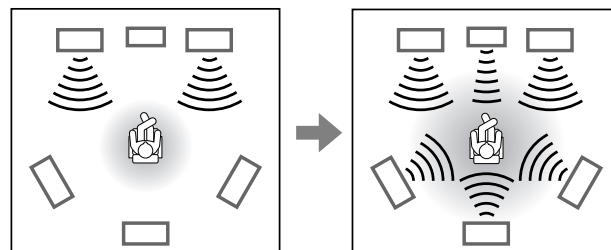

Sound reproduced from normal stereo

Sound reproduced from All Channel Stereo mode

3D HEADPHONE mode

If you connect a pair of headphones while one of the DSP modes is in use, the 3D HEADPHONE mode is activated without respect to the type of software played back. “3DHEADPHONE” appears on the display and the DSP, 3D, and HP indicators light up.

Using the Surround/DSP modes

Available Surround/DSP modes vary depending on the speaker settings and the incoming signals. See the table below.

- The numbers inside the parentheses following the incoming signal type indicate the number of the front channels and that of the surround channels. For example, (3/2) indicates that the signals are encoded with three front signals (left/right/center) and two (stereo) surround signals.
- For EX/ES/PLIIX setting, see page 22.

The name of the mode shown below is the display indication.

Incoming Signal Type		EX/ES/PLIIX setting				
		AUTO	ON	PLIIX MOVIE	PLIIX MUSIC	OFF
Dolby Digital	Dolby Digital Surround EX	DOLBY D EX*2*5	DOLBY D EX*2	DOLBY D EX*2*3	D + PLIIX MU*2	DOLBY D
	Dolby Digital (3/2, 2/2)	DOLBY D	DOLBY D EX*2	DOLBY D EX*2*3	D + PLIIX MU*2	DOLBY D
	Dolby Digital (3/1, 2/1, 3/0, 1/0)	DOLBY D				
	Dolby Digital (Dual Mono)	DUAL MONO				
DTS	DTS-ES Discrete*1	ES DISCRETE*2	ES DISCRETE*2	DTS + D EX*2*3	DTS + PLIIX MU*2	DTS
	DTS-ES Matrix*1	ES MATRIX*2	ES MATRIX*2	DTS + D EX*2*3	DTS + PLIIX MU*2	DTS
	DTS (3/2, 2/2)*1	DTS	DTS + NEO:6*2	DTS + D EX*2*3	DTS + PLIIX MU*2	DTS
	DTS (3/1, 2/1, 3/0, 1/0)	DTS				
	DTS (Dual Mono)	DUAL MONO				
Dolby Digital (2/0) DTS (2/0) Linear PCM Analog		PLIIX MOVIE*4/PLIIX MUSIC*4/NEO:6CINEMA/NEO:6 MUSIC				PLII MOVIE PLII MUSIC NEO:6CINEMA NEO:6 MUSIC
DVD MULTI		None				

*1 DTS 96/24 processing is not applied when the EX/ES/PLIIX setting is activated. If you want to apply the processing, set the EX/ES/PLIIX setting to "EX/ES/PLIIX: OFF" (see page 22).

*2 When "SURROUND BACK SPEAKER" is set to "SURR. BACK SPK: NO" (see page 21), Virtual Surround Back is activated for the modes.

*3 When using PLIIX Movie to reproduce Dolby Digital or DTS software, this receiver applies Dolby Digital EX (DOLBY D EX) or DTS plus Dolby Digital EX (DTS + D EX) processing (6.1-channel reproduction) to the software.

*4 When "SURROUND BACK SPEAKER" is set to "SURR. BACK SPK: NO" (see page 21), "PLIIX MOVIE" is changed to "PLII MOVIE" and "PLIIX MUSIC" is changed to "PLII MUSIC."

*5 For some Dolby Digital Surround EX software, Dolby Digital 5.1-channel reproduction ("DOLBY D") may be applied. In this case, select "EX/ES/PLIIX: ON" to apply "DOLBY D EX."

About the DSP modes

- The following DSP modes are available regardless of incoming signal type:
HALL1, HALL2, LIVE CLUB, DANCE CLUB, PAVILION, THEATER1, THEATER2
- When an incoming signal is a multi-channel (more than 2-channel) digital signal, "MONO FILM" is not available.
- You cannot select "ALL CH ST" when the surround speakers are set to "NO" in the speaker setting (see page 21).

Virtual Surround Back

This function creates the great surround effect from the behind as if you have connected the surround back speaker. The VIRTUAL SB (Surround Back) indicator lights up on the display.

If you have connected (and activated) the surround speakers, you can use Virtual Surround Back without connecting the surround back speaker.

Virtual Surround Back is activated when "EX/ES/PLIIX" is set to other than "EX/ES/PLIIX: OFF" and when playing back the software including the following signals:

- Dolby Digital Surround EX
- DTS-ES
- Dolby Digital or DTS with more than 4-channels

Virtual Surround Back is activated when one of the Surround modes is selected.

Activating the Surround/DSP modes

Available Surround/DSP modes vary depending on the incoming signals. For details, see page 38.

Activating one of the Surround/DSP modes automatically recalls the memorized settings and adjustments.

- To adjust the speaker output level, see page 29.
- To adjust the effect level for the DSP mode (except All Channel Stereo mode,) see page 31.
- To add “wraparound” sound effect to “PLII MUSIC” (PANORAMA control,) see page 31.
- To adjust the sound localization of the center channel for “NEO:6 MUSIC” (center gain,) see page 31.
- To adjust the vertical localization of the center channel for Surround/DSP modes (except “PLII MUSIC,” “PLIIX MUSIC,” “Neo6: MUSIC,” and “ALL CH ST”) (center alignment,) see page 31.

NOTES

- You cannot use any Surround/DSP modes when selecting “DVD MULTI” as the playback source.
- The on-screen display appears on the TV screen to show the Surround/DSP mode name for 5 seconds when you select the Surround/DSP mode.
To cancel the function, set “SUPERIMPOSE” to “SUPERIMPOSE: OFF” (see page 25).

From the remote control:

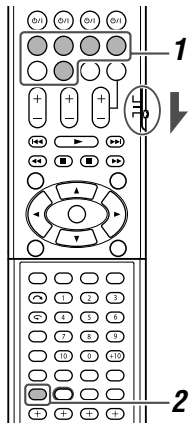

When operating the receiver using the remote control, set the mode selector to “AUDIO/TV/VCR/DBS.”

1 Select and play any source other than “DVD MULTI.”

- Make sure you have selected the input mode (analog or digital) correctly.

2 Press SURROUND repeatedly to select the Surround/DSP mode you want.

Ex.: When “DOLBY D” is selected for Dolby Digital multi-channel software:

DOLBY D

AUTO SURR	↔ Surround modes* ↔	
HALL1	↔ HALL2 ↔	
LIVE CLUB	↔ DANCE CLUB ↔	
PAVILION	↔ THEATER1 ↔	
THEATER2	↔ MONO FILM ↔	
ALL CH ST	↔ SURR OFF ↔	

(Back to the beginning)

To cancel Surround/DSP modes

Press SURROUND repeatedly so that “SURR OFF” appears on the display.

On the front panel:

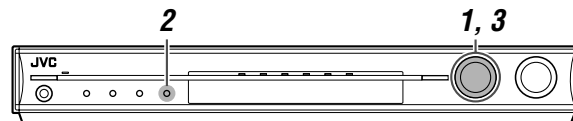

Before you start, remember...

There is a time limit in doing the following steps. If the setting is canceled before you finish, start from step 2 again.

1 Select and play any source other than “DVD MULTI.”

- Make sure you have selected the input mode (analog or digital) correctly.

2 Press SURROUND.

MULTI JOG now works for selecting Surround/DSP modes.

3 Turn MULTI JOG to select the Surround/DSP mode you want.

Ex.: When “DOLBY D” is selected for Dolby Digital multi-channel software:

DOLBY D

AUTO SURR	↔ Surround modes* ↔	
HALL1	↔ HALL2 ↔	
LIVE CLUB	↔ DANCE CLUB ↔	
PAVILION	↔ THEATER1 ↔	
THEATER2	↔ MONO FILM ↔	
ALL CH ST	↔ SURR OFF ↔	

(Back to the beginning)

To cancel Surround/DSP modes

Turn MULTI JOG so that “SURR OFF” appears on the display.

NOTE

The initial setting is “AUTO SURR.”

- * Available Surround modes vary depending on the incoming signals. For details, see “Using the Surround/DSP modes” on page 38.

When you select “AUTO SURR” (Auto Surround)

You can enjoy the Surround mode easily.

- For details about the Surround modes, see pages 34 to 36.
- When “AUTO SURR” is activated, the AUTO SR indicator lights up on the display.

How does “AUTO SURR” work?

- If a multi-channel signal comes in, an appropriate Surround mode will be selected automatically.
- If a Dolby Digital 2-channel or DTS 2-channel signal with surround signal comes in, “PLII MOVIE” will be selected.
- If a Dolby Digital 2-channel or DTS 2-channel signal without surround signal, or a Linear PCM signal comes in, “SURR OFF (stereo)” will be selected.

NOTES

- “AUTO SURR” does not take effect in the following cases:
 - While playing an analog source.
 - While selecting one of the fixed digital decode modes—“DOLBY D” or “DTS” (see page 13).
- While listening with the headphones, the 3D HEADPHONE mode (see pages 36 and 37) is activated without respect to the type of software played back.
- When “AUTO SURR” is selected, sound may not come out at the beginning of playback. If it occurs, select a Surround mode manually.

AV COMPU LINK remote control system

The AV COMPU LINK remote control system allows you to operate JVC's video components (TV, DVD player*, and VCR) through this receiver.

This receiver is equipped with the AV COMPU LINK-III, which has added a function to operate JVC's video components through the component video jacks. To use this remote control system, you need to connect the video components you want to operate, following the diagrams below and the procedures on page 41.

- Refer also to the manuals supplied with your video components.

* "DVD player" on pages 40 and 41 can be replaced with "DVD recorder."

Connections 1: AV COMPU LINK connection

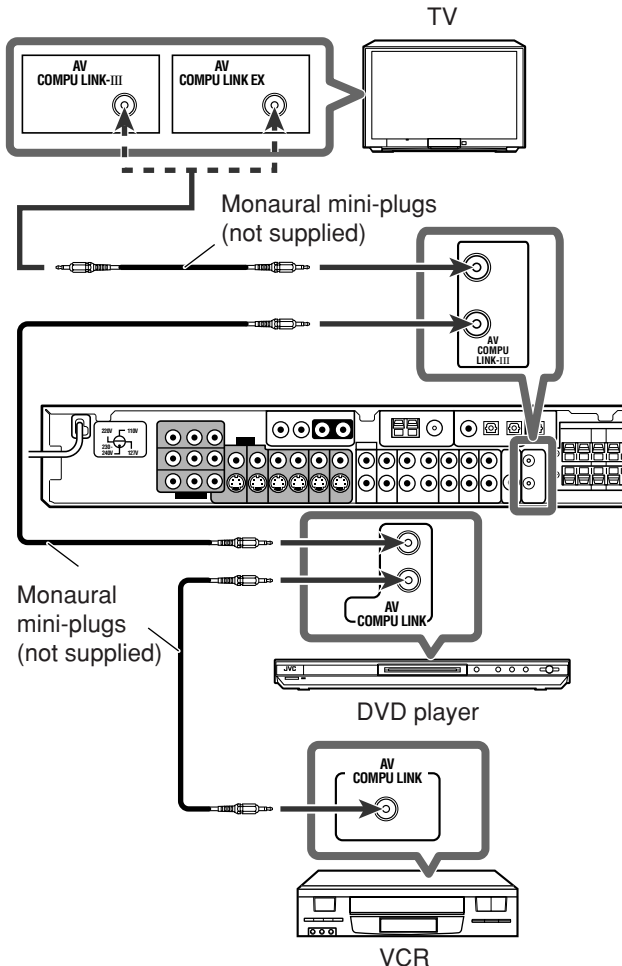

IMPORTANT:

The AV COMPU LINK remote control system cannot control the DBS tuner connected to the DBS IN jacks.

NOTES

- When connecting the receiver and a TV with the AV COMPU LINK EX terminal by using a component video cable, you cannot use Automatic selection of TV's input mode (see page 41).
- When connecting only the VCR and DVD player to this receiver, connect it directly to the receiver using cable with the monaural mini-plugs.
- You can connect only the TV with AV COMPU LINK EX or AV COMPU LINK-III terminal to the AV COMPU LINK-III terminal.

Connections 2: Video cable connection

This receiver is equipped with three types of the video terminals—composite video, S-video, and component video, and the signals coming into this receiver through one type of video terminals can output only through the terminal of the same type. So you need to connect the video components to this receiver using one of the following three ways.

- When using the AV COMPU LINK remote control system, set the video input for the DVD player and the VCR correctly (see "Selecting the component video input mode—DVD VIDEO INPUT/VCR VIDEO INPUT" on page 25); otherwise, the correct input for this receiver will not be selected on the TV.

Case 1*:

When connecting the source equipment to the receiver through the S-video terminals, connect this receiver to the TV's video input 1 terminal using S-video cables.

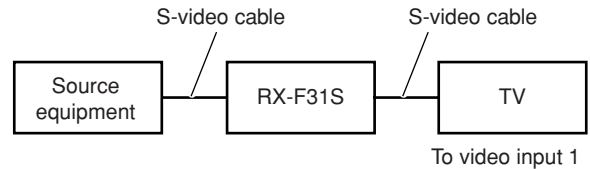

Case 2*:

When connecting the source equipment to the receiver through the composite video jacks, connect this receiver to the TV's video input 2 terminal (composite video input) using composite video cables.

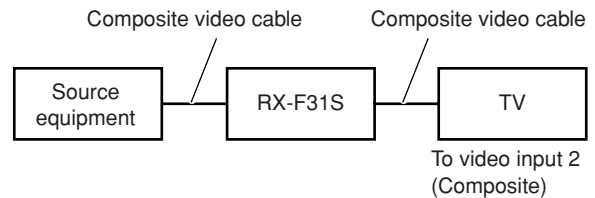

Case 3:

When connecting the source equipment to the receiver through the component video jacks, connect this receiver to the TV's video input 2 terminals (component video input) using component video cables.

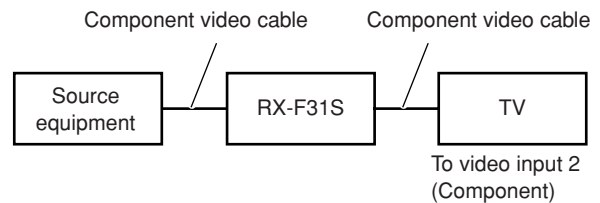

- * When using the AV COMPU LINK remote control system, set "DOWN MIX" and "Y/C SEPARATE" to "OFF"; otherwise, this system does not work correctly. For details about each setting, see page 25.

Connecting procedure

- 1 If you have already plugged your VCR, DVD player, TV, and this receiver into the AC outlets, unplug their AC power cords first.**
- 2 Connect your VCR, DVD player, TV, and this receiver as follows, using the cables with the monaural mini-plugs (not supplied).**
 - See "Connections 1" on the previous page.
- 3 Connect the audio input/output jacks on the VCR, DVD player, TV, and this receiver using the audio cables.**
 - See pages 7 to 10.
- 4 Connect the video input/output jacks on the VCR, DVD player, TV, and this receiver using the S-video cables, composite video cables, or component video cables.**
 - See "Connections 2" on the previous page.
- 5 Plug the AC power cords of the connected components and this receiver into the AC outlets.**
- 6 When turning on the TV for the first time after the AV COMPU LINK connection, turn the TV volume to the minimum using the TV volume control on the TV.**
- 7 Turn on other connected components first, then turn on this receiver.**
 - When turning on the VCR, use the remote control supplied with this receiver (press VCR \odot /I).

The AV COMPU LINK remote control system allows you to use the five basic functions listed below.

Remote control of the TV, DVD player, and VCR using this remote control

See pages 42 and 43 for details.

- Aim the remote control directly at **the remote sensor on each component.**

One-touch video play

Simply by inserting a video cassette without its safety tab into the VCR, you can enjoy the video playback without setting other switches manually. The receiver automatically turns on and changes the source to "VCR" (or "VCR DIGITAL").

The TV automatically turns on and changes the input mode to the appropriate position so that you can view the playback picture. When you insert a video cassette with its safety tab, press the play (▶) button on the VCR or on the remote control. So, you can get the same result.

One-touch DVD play

Simply by starting playback on the DVD player, you can enjoy the DVD playback without setting other switches manually.

- When the DVD player is connected through the analog input jacks on this receiver (and analog input is selected), the receiver automatically turns on and changes the source to "DVR/DVD" or "DVD MULTI."
- When the DVD player is connected through the digital input terminal on this receiver (and digital input is selected), the receiver automatically turns on and changes the source to "DVR/DVD DGT."

The TV automatically turns on and changes the input mode to the appropriate position so that you can view the playback picture.

Automatic selection of TV's input mode

- When you select "TV" (or "TV DIGITAL") as the source to play on the receiver, the TV automatically changes the input mode to the TV tuner so that you can watch TV.
- When you select "DVR/DVD" (or "DVR/DVD DGT"), "DVD MULTI," "VCR" (or "VCR DIGITAL"), or "DBS" (or "DBS DIGITAL") as the source to play on the receiver, the TV automatically changes the input mode to the appropriate position (either video input 1 or video input 2) so that you can view the playback picture.

NOTE

This function does not work when you connect this receiver and the TV with the AV COMPU LINK EX terminal using a component video cable. In this case, reconnect the TV referring to Case 1 or Case 2 on page 40.

Automatic power on/off

The TV, DVD player, and VCR turn on and off along with the receiver.

When you turn on the receiver;

- If the previously selected source is "TV" (or "TV DIGITAL") or "DBS" (or "DBS DIGITAL"), only the TV will turn on automatically.
- If the previously selected source is "DVR/DVD" (or "DVR/DVD DGT") or "DVD MULTI," the TV and DVD player will turn on automatically.
- If the previously selected source is "VCR" (or "VCR DIGITAL"), the TV and VCR will turn on automatically.

When you turn off the receiver, the TV, DVD player, and VCR will turn off.

NOTE

If you turn off the receiver while recording on the VCR, the VCR will not turn off, but continue recording.

Operating other JVC products

You can use the supplied remote control to operate not only this receiver but also other JVC products.

- Refer also to the manuals supplied with the other products. Some JVC VCRs can accept two types of the control signals—remote codes “A” and “B.”
 - When operating a VCR whose remote control code is set to “A,” set the manufacturer’s code to “01.”
 - When operating a VCR whose remote control code is set to “B,” set the manufacturer’s code to “02.”
 The initial setting is “01.” For details about the setting, see “Changing the transmittable signals for operating a VCR” on page 45.
- To operate other products, aim the remote control directly at the remote sensor on the target product.

■ TV

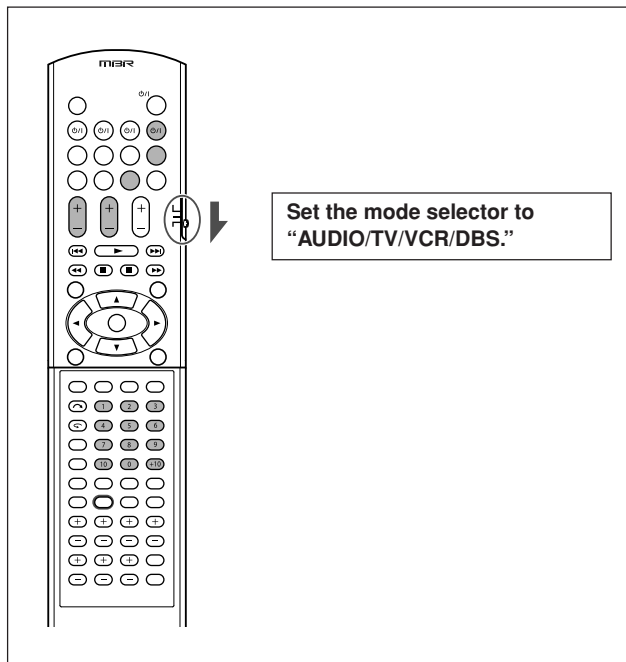

You can always perform the following operations:

TV \odot/I:	Turn on or off the TV.
TV VOL +/-:	Adjust the volume on the TV.
TV/VIDEO:	Change the input mode (either video input or TV tuner) on the TV.

After pressing TV, you can perform the following operations on the TV.

CHANNEL +/-:	Change the channel numbers.
1 – 9, 0, 100+:	Select the channel numbers.
TV RETURN (10):	Function as the TV RETURN button. (Switches between the previous channel and the current channel.)

■ VCR

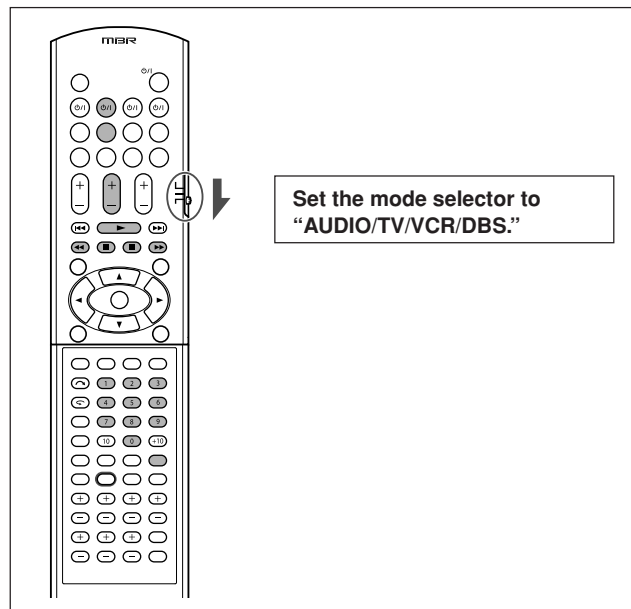

You can always perform the following operation:

VCR \odot/I:	Turn on or off the VCR.
----------------------------------	-------------------------

After pressing VCR, you can perform the following operations on the VCR.

CHANNEL +/-:	Change the channel numbers on the VCR.
1 – 9, 0:	Select the channel numbers on the VCR.
▶:	Start playback.
■:	Stop playback.
 :	Pause playback. To release it, press ▶.
▶▶:	Fast-wind a tape.
◀◀:	Rewind a tape.
REC PAUSE:	Enter recording pause. To start recording, press this button then ▶.

■ DVD recorder or DVD player

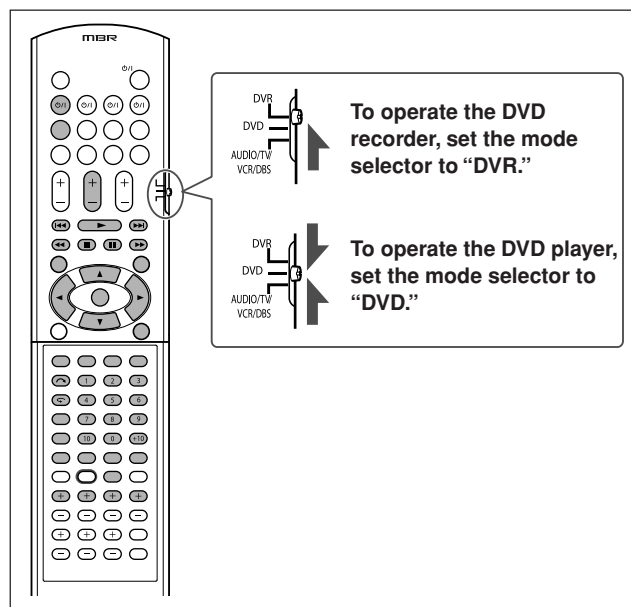

After setting the mode selector correctly, you can perform the following operations on the DVD recorder or DVD player.

See the instructions supplied with the DVD recorder or DVD player for details.

■ Changing the remote control code for DVD recorder

Some JVC DVD recorders can accept four types of the control signals. You can assign one of the four codes to the remote control supplied with this receiver for operating your DVD recorder. For details, refer to the manual supplied with the DVD recorder.

Initial setting: 03

- 1 Set the mode selector to "DVR."
- 2 Press and hold DVR/DVD \odot /I.
- 3 Press DVR/DVD.
- 4 Enter the remote control code you want using buttons 1 – 4, and 0.

EX.: To enter the code "2", press 0, then 2.

Code for DVR	Number to enter
1	01
2	02
3	03
4	04

5 Release DVR/DVD \odot /I.

Now, the remote control code has been changed.

You can always perform the following operation:

DVR/DVD \odot/I:	Turn on or off the DVD recorder or DVD player.
▶:	Start playback.
■:	Stop playback.
II:	Pause playback. To release it, press ▶.
▶▶:	Skip to the beginning of the next chapter.
◀◀:	Return to the beginning of the current (or previous) chapter.
▶▶▶:	Fast-forward playback.
◀◀◀:	Fast-reverse playback.
TOP MENU/MENU:	Display the menu recorded on discs.
ON SCREEN:	Shows the on-screen bar.
▲/▼/▶/◀:	Select an item on the menu screen.
ENTER:	Enter the selected item, channel number, chapter/title number, or track number (if required).

You can also use the following buttons to operate JVC DVD recorder and/or DVD player if it supports the corresponding function:

For various settings:

AUDIO:	Select the audio language/channel.
SUBTITLE:	Select the subtitle language.
SET UP:	Display the Preference display.
VFP:	Show the picture adjustment screen.
PROGRESSIVE*:	Change the scanning mode.
ANGLE:	Select the view angle.

For various playback:

↶ (one touch replay):	Move the playback position back 10 seconds before the current position.
RETURN:	Return to the main menu during menu operation.
CANCEL:	Cancel the programmed track, etc.

Only for DVD recorder operations:

CHANNEL +/-:	Change the channel numbers.
DVD/HDD:	Select the DVD recorder or HDD deck. (Only for a DVD recorder incorporated with HDD deck.)
↷ (skip):	Move the playback position ahead 30 seconds after the current position.
1 – 9, 0:	Select a channel number (while stopped) or a chapter/title number, track number (while playing back). Press ENTER to enter the number.
REC MODE:	Select the recording mode.
REC PAUSE:	Enter recording pause. To start recording, press ▶.
DISPLAY:	Change the display information.

Only for DVD player operations:

fs/Rate*:	Show the sampling frequency.
TITLE/GROUP:	Make the numeric buttons work for selecting the title/group number.
ZOOM:	Zoom in and out.
1 – 10, 0, +10:	Select a chapter/title number, track number, menu item, etc.
DVD/CARD:	Select the disc or memory card to play. (Only for a DVD player incorporated with memory card slots.)
DIMMER:	Change the display brightness.
THUMBNAIL:	Show the thumbnail screen for JPEG discs.
SLIDE:	Start the slide show playback for JPEG discs.
3D/S.EFFECT:	Apply the 3D effect.
PAGE:	Show browsable still pictures on DVD Audio discs.

* Press and hold when using these buttons.

If these buttons do not function normally, use the remote control supplied with your DVD recorder or DVD player. Refer also to the manuals supplied with the DVD recorder or DVD player for details.

Operating other manufacturers' products

By changing the transmittable signals, you can use the supplied remote control to operate other manufacturers' products.

- Refer also to the manuals supplied with the other products.
- To operate those components with the remote control, first you need to set the manufacturers' codes each for the TV, VCR, and DBS.
- After replacing batteries of the remote control, set the manufacturers' codes again.

□ Changing the transmittable signals for operating a TV

Set the mode selector to "AUDIO/TV/VCR/DBS."

1 Press and hold TV ϕ /I.

2 Press TV.

3 Enter the manufacturer's code using buttons 1 – 9, and 0.

See "Manufacturers' codes for TV" on the right.

4 Release TV ϕ /I.

Now, you can perform the following operations on the TV.

TV ϕ /I:	Turn on or off the TV.
TV VOL +/-:	Adjust the volume on the TV.
TV/VIDEO:	Change the input mode (either TV or VIDEO).

After pressing TV, you can perform the following operations on the TV.

CHANNEL +/-:	Change the channel numbers.
1 – 9, 0, 100+ (+10):	Select the channel numbers.

See the instructions supplied with the TV for details.

5 Try to operate your TV by pressing TV ϕ /I.

When your TV turns on or off, you have entered the correct code.

If more than one code is listed for your brand of TV, try each one until the correct one is entered.

Manufacturers' codes for TV

Manufacturer	Codes
JVC	01
Akai	02
Bell+Howell	03
Centurion	04
Coronad	05
Daewoo	06, 07, 08
Emerson	09, 10, 11, 12, 13
Fisher	14
GE•Pana	15, 16
GE•RCA	17
Gold Star	18, 19
Hitachi	20, 21
KTV	22, 23
Magnavox	24
Marantz	25
Mitsubishi	25
Panasonic	26, 27
Philips	24
Pioneer	28
Proscan	29
Quasar	30
Radioshack	31
RCA	02, 17, 32, 33, 34, 35
Samsung	36, 37
Sanyo	14
Sears	38
Sharp	39
Sony	40
Symphonic	41, 42
Toshiba	38
Zenith	43, 44

Initial setting: 01

Manufacturers' codes are subject to change without notice. If they are changed, this remote control cannot operate the equipment.

□ Changing the transmittable signals for operating a VCR

Set the mode selector to "AUDIO/TV/VCR/DBS."

1 Press and hold VCR \odot/I .

2 Press VCR.

3 Enter the manufacturer's code using buttons 1 – 9, and 0.

See "Manufacturers' codes for VCR" on the right.

4 Release VCR \odot/I .

Now, you can perform the following operation on the VCR.

VCR \odot/I :	Turn on or off the VCR.
-------------------------------	-------------------------

After pressing VCR, you can perform the following operations on the VCR.

CHANNEL +/- :	Change the channel numbers on the VCR.
----------------------	--

1 – 9, 0 :	Select the channel numbers on the VCR.
-------------------	--

▶ :	Start playback.
------------	-----------------

■ :	Stop playback.
------------	----------------

⏸ :	Pause playback.
------------	-----------------

▶▶ :	Fast-wind a tape.
-------------	-------------------

◀◀ :	Rewind a tape.
-------------	----------------

See the instructions supplied with the VCR for details.

5 Try to operate your VCR by pressing VCR \odot/I .

When your VCR turns on or off, you have entered the correct code.

If more than one code is listed for your brand of VCR, try each one until the correct one is entered.

Manufacturers' codes for VCR

Manufacturer	Codes
JVC	01, 02, 03, 04
Aiwa	05
Akai	06, 07, 08
Bell+Howell	09
Daewoo	10
Emerson	11, 12, 13, 14, 15
Fisher	16, 17, 18, 19
G.E.	20, 21
Go Video	22
Gold Star	23
Go-Video A	24
Go-Video B	25
Hitachi	20, 26
Magnavox	27, 28, 29
Mitsubishi	30, 31, 32, 33
NEC	34, 35
Panasonic	36, 37
Philips	27
RCA	38
Samsung	39, 40, 41
Sanyo	16, 17, 18, 19
Scott	42
Sharp	43, 44
Shintom	45
Sony	46, 47, 48, 49, 50, 51
Symphonic	52
Teknica	53, 54
Toshiba	55
Zenith	56

Initial setting: 01

Manufacturers' codes are subject to change without notice. If they are changed, this remote control cannot operate the equipment.

❑ Changing the transmittable signals for operating a DBS tuner

Set the mode selector to "AUDIO/TV/VCR/DBS."

- 1 Press and hold DBS \odot/I .
- 2 Press DBS.
- 3 Enter the manufacturer's code using buttons 1 – 9, and 0.

See "Manufacturers' codes for DBS tuner" below.

4 Release DBS \odot/I .

Now, you can perform the following operation on the DBS tuner.

DBS \odot/I:	Turn on or off the DBS tuner.
---	-------------------------------

After pressing DBS, you can perform the following operations on the DBS tuner.

CHANNEL +/-:	Change the channel numbers on the DBS tuner.
1 – 9, 0:	Select the channel numbers on the DBS tuner.

See the instructions supplied with the DBS tuner for details.

5 Try to operate your DBS tuner by pressing DBS \odot/I .

When your DBS tuner turns on or off, you have entered the correct code.

If more than one code is listed for your brand of DBS tuner, try each one until the correct one is entered.

Manufacturers' codes for DBS tuner

Manufacturer	Codes
Echostar	40
G.I.	01, 41
Gemini	02
Hamlin	03, 04, 05, 06
Hitachi	42
Hughes	43
Jerrold	07, 08, 09, 10, 11, 12, 13, 14, 15
Macom	16, 17, 18
Magnavox	19
Oak	20, 21, 22
Panasonic	23, 24, 44
Philips	25, 26, 27, 28, 29, 30
Pioneer	31, 32
Primestar	45
RCA	46
S. Atlanta	33, 34, 35
Samsung	36
Sony	47
Tocom	37
Toshiba	48
Zenith	38, 39

Initial setting: 01

❑ Changing the transmittable signals for operating a DVD player

Set the mode selector to "DVD."

- 1 Press and hold DVR/DVD \odot/I .
- 2 Press DVR/DVD.
- 3 Enter the manufacturer's code using buttons 1 – 9, and 0.

See "Manufacturers' codes for DVD player" below.

4 Release DVR/DVD \odot/I .

Now, you can perform the following operation on the DVD player.

DVR/DVD \odot/I:	Turn on or off the DVD player.
---	--------------------------------

▶:	Start playback.
◀◀:	Return to the beginning of the current chapter (or fast-forward for some models).
▶▶:	Skip to the beginning of the next chapter (or fast-reverse for some models).
■:	Stop playback.
 :	Pause playback.
MENU:	Display the menu recorded on DVD VIDEO discs.
▲/▼/▶/◀:	Select an item on the menu screen.
ENTER:	Enter the selected item.
1 – 9, 0:	Select the chapter number.

See the instructions supplied with the DVD player for details.

5 Try to operate your DVD player by pressing DVR/DVD \odot/I .

When your DVD player turns on or off, you have entered the correct code.

If more than one code is listed for your brand of DVD player, try each one until the correct one is entered.

Manufacturers' codes for DVD player

Manufacturer	Codes
JVC	01
Hitachi	12
Kenwood	05, 08
Mitsubishi	10
Onkyo	15, 16
Panasonic	04
Philips	07
Pioneer	03
Samsung	14
Sony	02
Toshiba	06
Yamaha	09

Initial setting: 01

NOTE

You cannot use this remote control to operate other manufacturers' DVD recorder.

Manufacturers' codes are subject to change without notice. If they are changed, this remote control cannot operate the equipment.

Troubleshooting

Use this chart to help you solve daily operational problems. If there are any problems you cannot solve, contact your JVC's service center.

	PROBLEM	POSSIBLE CAUSE	SOLUTION
Power	The power does not come on.	The power cord is not plugged in.	Plug the power cord into an AC outlet.
	The receiver turns off (enters standby mode).	Speakers are overloaded because of high volume.	1. Stop the playback source. 2. Turn on the receiver again, then turn the volume down.
		Speakers are overloaded because of a short circuit at the speaker terminals.	Check the speaker wiring. If speaker wiring is not short-circuited, contact your dealer.
		The receiver is overloaded because of a high voltage.	Consult your dealer after unplugging the power cord.
"OVER HEAT" flashes on the display, then the receiver turns off.	The receiver is overloaded because of high volume or long time usage.	Turn on the receiver again. If the receiver turns off soon, consult your dealer after unplugging the power cord.	
Sound and picture	No sound from speakers.	Speaker signal cables are not connected.	Check speaker wiring, then reconnect if necessary (see page 6) after unplugging the power cord.
		Connections are incorrect.	Check the audio connections (see pages 7 to 11) after unplugging the power cord.
		An incorrect source is selected.	Select the correct source.
		Muting is activated.	Press MUTING to cancel the mute (see page 15).
		An incorrect input mode (analog or digital) is selected.	Select the correct input mode (analog or digital).
	TV Direct is activated.	Deactivate TV Direct (see page 14).	
	Sound from one speaker only.	Speaker signal cables are not connected properly.	Check speaker wiring and reconnect if necessary (see page 6) after unplugging the power cord.
Bass sound is reinforced too much when listening in stereo.	Appropriate bass level is not selected.	Adjust audio position level (see page 14).	
Sounds are intermittently distorted or the noise is heard by the outside noise such as a lightning discharge.	The sounds may be intermittently distorted or the noise may be heard by the outside noise such as a lightning discharge but the sound will be restored automatically.	This is not a malfunction. But if this continues, turn on the receiver again.	
No picture is displayed on the monitor.	Connections are incorrect.	Check the video connections (see pages 7 to 10) after unplugging the power code.	
	Input mode is incorrect.	Check the component video input mode (see page 25).	
Remote control	Remote control does not operate as you intend.	The remote control is not ready for your intended operation.	Set the mode selector correctly, then press the corresponding source selecting button or SOUND before operation
	Remote control does not work.	There is an obstruction hiding the remote sensor on the receiver.	Remove the obstruction.
		Batteries are weak.	Replace batteries.
		The mode selector is set to the incorrect position.	Set the mode selector to the proper position.
Buttons cannot be used.	TV Direct is activated.	Deactivate TV Direct (see page 14).	
Tuner	Continuous hiss or buzzing during FM reception.	Incoming signal is too weak.	Connect an outdoor FM antenna or contact your dealer.
		The station is too far away.	Select another station.
		The wrong antenna is being used.	Check with your dealer to be sure you have the correct antenna.
		Antennas are not connected properly.	Check the connections.
	Occasional cracking noise during FM reception.	Ignition noise from automobiles.	Move the antenna farther from automobile traffic.

Specifications

Designs and specifications are subject to change without notice.

Amplifier

Output Power

At stereo operation:

Front channels: 100 W* per channel, min. RMS, driven into 6 Ω at 1 kHz with no more than 10% total harmonic distortion.

At surround operation:

Front channels: 100 W* per channel, min. RMS, driven into 6 Ω at 1 kHz with no more than 0.8% total harmonic distortion.

Center channel: 100 W*, min. RMS, driven into 6 Ω at 1 kHz, with no more than 0.8% total harmonic distortion.

Surround channels: 100 W* per channel, min. RMS, driven into 6 Ω at 1 kHz, with no more than 0.8% total harmonic distortion.

Surround back channel: 100 W*, min. RMS, driven into 6 Ω at 1 kHz, with no more than 0.8% total harmonic distortion.

* Measured on AC 110 V, 127 V, 220 V, and 240 V.

Audio

Audio Input Sensitivity/Impedance:

DVR/DVD (DVD MULTI), VCR, DBS, TV:
330 mV/47 k Ω

Audio Input (DIGITAL IN)*:

Coaxial: DIGITAL IN 1(DVR/DVD):
0.5 V(p-p)/75 Ω

Optical: DIGITAL IN 2(DBS), 3(VCR):
-21 dBm to -15 dBm
(660 nm \pm 30 nm)

* Corresponding to Linear PCM, Dolby Digital, and DTS (with sampling frequency—32 kHz, 44.1 kHz, 48 kHz).

Audio Output Level:

DVR, VCR, MONITOR OUT: 330 mV

Signal-to-Noise Ratio (*66 IHF/DIN): 80 dB/62 dB

Frequency Response (8 Ω): 20 Hz to 20 kHz (\pm 1 dB)

Bass Boost: +4 dB \pm 1 dB at 100 Hz

Equalization (at DSP operation):

Center frequency: 63 Hz, 250 Hz, 1 kHz, 4 kHz, 16 kHz
Control range: \pm 8 dB

Video

Video Input Sensitivity/Impedance:

Composite video: DVR/DVD, VCR, DBS:
1 V(p-p)/75 Ω

S-video: DVR/DVD, VCR, DBS:

Y (luminance): 1 V(p-p)/75 Ω

C (chrominance, burst): 0.3 V(p-p)/75 Ω

Component: DVR/DVD, VCR:

Y (luminance): 1 V(p-p)/75 Ω

PB, PR: 0.7 V(p-p)/75 Ω

Video Output Level/Impedance:

Composite video: DVR, VCR, MONITOR OUT:
1 V(p-p)/75 Ω

S-video: DVR, VCR, MONITOR OUT:

Y (luminance): 1 V(p-p)/75 Ω

C (chrominance, burst): 0.3 V(p-p)/75 Ω

Component: MONITOR OUT:

Y (luminance): 1 V(p-p)/75 Ω

PB, PR: 0.7 V(p-p)/75 Ω

Synchronization: Negative

FM tuner (IHF)

Tuning Range: 87.50 MHz to 108.00 MHz

Usable Sensitivity:

Monaural: 12.8 dBf (1.2 μ V/75 Ω)

50 dB Quieting Sensitivity:

Monaural: 16.0 dBf (1.7 μ V/75 Ω)

Stereo: 37.5 dBf (20.5 μ V/75 Ω)

Stereo Separation at OUT(REC): 35 dB at 1 kHz

AM tuner

Tuning Range: 531 kHz to 1 710 kHz (at 9 kHz intervals)

530 kHz to 1 710 kHz (at 10 kHz intervals)

General

Power Requirements: AC 110 V/127 V/220 V/230 V – 240 V \sim , adjustable with the voltage selector, 50 Hz/60 Hz

Power Consumption: 120 W (at operation)

5 W (in standby mode)

Dimensions (W x H x D): 435 mm x 70 mm x 317.2 mm

Mass: 6.3 kg

Mains (AC) Line Instruction (not applicable for Europe, U.S.A., Canada, and U.K.)

主 (AC) 电源线路说明 (不适用于欧洲、美国、加拿大、及英国型号)

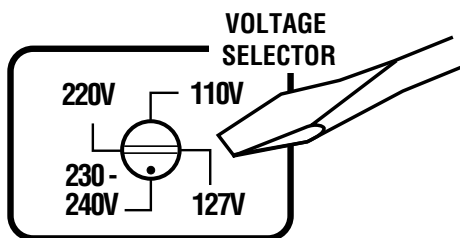
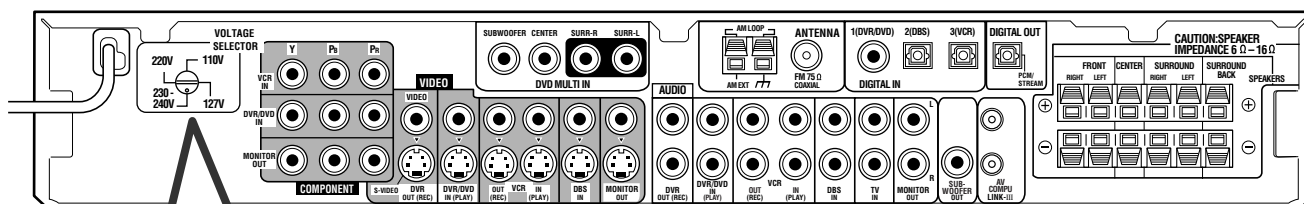

CAUTION for mains (AC) line

BEFORE PLUGGING IN, do check that your mains (AC) line voltage corresponds with the position of the voltage selector switch provided on the outside of this equipment and, if different, reset the voltage selector switch, to prevent from a damage or risk of fire/electric shock.

有关主 (AC) 电源线路的重要事项

接插电源以前，请务必检查当地的主 (AC) 电源线路电压是否和位于本机外面的电压选择开关设定的位置一致。如果不一致，请重新设定电压选择开关使其符合当地电压，以免损坏机器或引起火灾/触电的危险。

JVC

JVC



HOME CINEMA CONTROL CENTER

RX-F31S

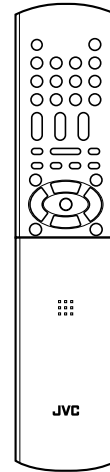
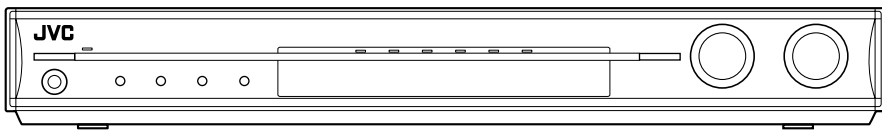

AV COMPU LINK

INSTRUCTIONS

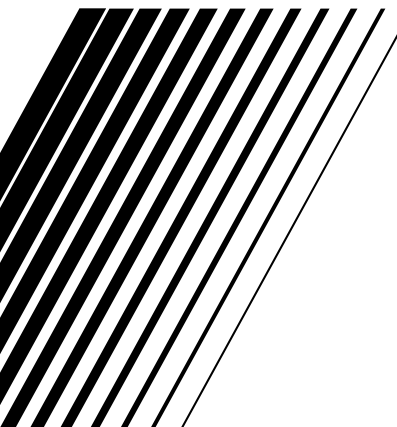

Warnings, Cautions, and Others

Caution—/I STANDBY/ON button!

Disconnect the mains plug to shut the power off completely. The /I STANDBY/ON button in any position does not disconnect the mains line. The power can be remote controlled.

CAUTION

To reduce the risk of electrical shocks, fire, etc.:

1. Do not remove screws, covers or cabinet.
2. Do not expose this appliance to rain or moisture.

CAUTION

- Do not block the ventilation openings or holes.
(If the ventilation openings or holes are blocked by a newspaper or cloth, etc., the heat may not be able to get out.)
- Do not place any naked flame sources, such as lighted candles, on the apparatus.
- When discarding batteries, environmental problems must be considered and local rules or laws governing the disposal of these batteries must be followed strictly.
- Do not expose this apparatus to rain, moisture, dripping or splashing and that no objects filled with liquids such as vases, shall be placed on the apparatus.

Caution: Proper Ventilation

To avoid risk of electric shock and fire and to protect from damage. Locate the apparatus as follows:

- Front: No obstructions open spacing.
Sides: No obstructions in 10 cm from the sides.
Back: No obstructions in 15 cm from the back.
Bottom: No obstructions, place on the level surface.

In addition, maintain the best possible air circulation as illustrated.

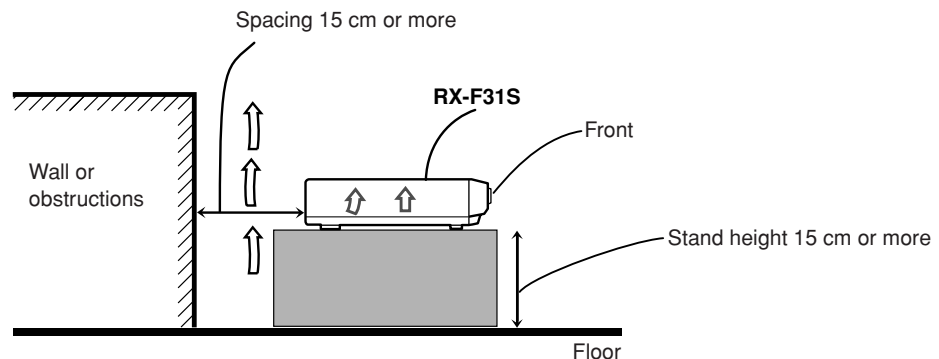
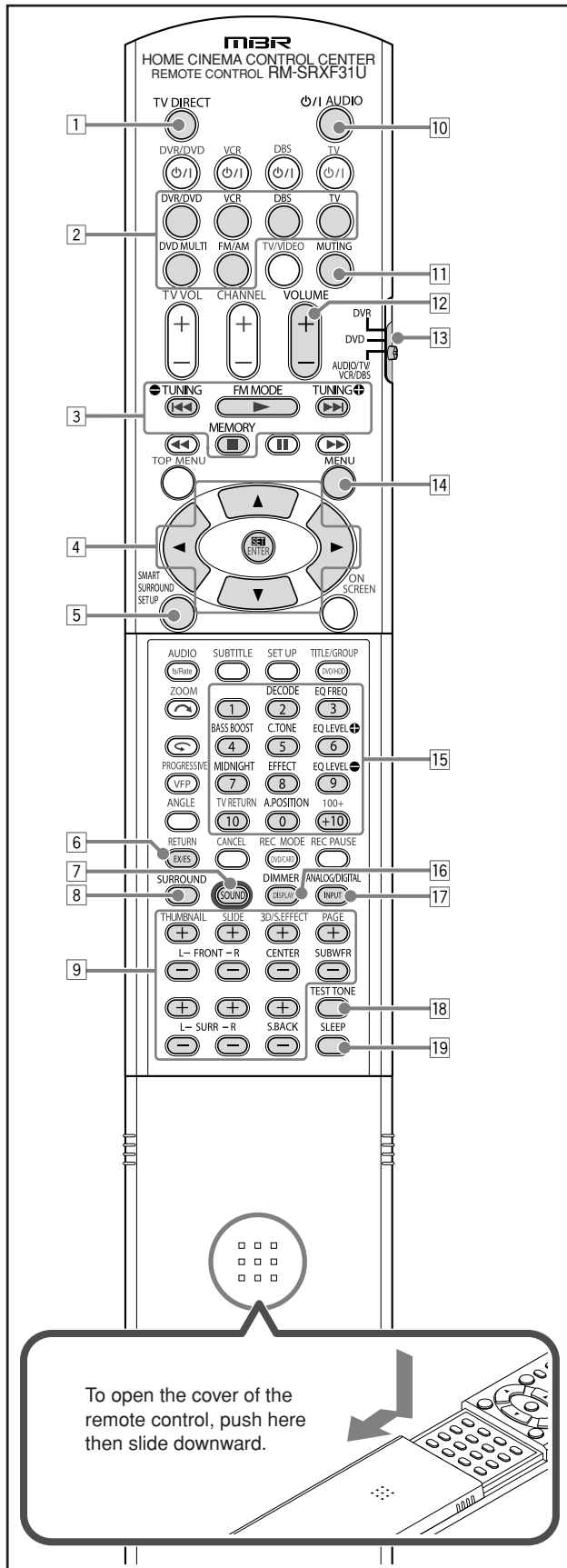

Table of Contents

Parts identification	2
Getting started	4
Before Installation	4
Checking the supplied accessories	4
Putting batteries in the remote control	4
Setting the voltage selector	4
Connecting the FM and AM antennas	5
Connecting the speakers	6
Connecting video components	7
Connecting the power cord	11
Basic operations	12
1 Turn on the power	12
2 Select the source to play	12
3 Adjust the volume	13
Selecting the digital decode mode	13
Adjusting the subwoofer audio position	14
Activating TV Direct	14
Turning off the sounds temporarily	15
Changing the display brightness	15
Turning off the power with the Sleep Timer	15
Basic settings	16
Setting the speaker information automatically	
—Smart Surround Setup	16
Basic setting items	18
Operation through on-screen display menus	18
Menu operation buttons	18
Setup menu configuration	19
Menu operating procedure	20
Setting the items	21
Setting the speakers	21
Activating the EX/ES/PLIIX setting—EX/ES/PLIIX	22
Selecting the main or sub channel—DUAL MONO	23
Setting bass sound	23
Using the Midnight mode—MIDNIGHT MODE	24
Setting the digital input (DIGITAL IN) terminals	
—DIGITAL IN 1/2/3	24
Selecting the component video input mode	
—DVD VIDEO INPUT/VCR VIDEO INPUT	25
Superimposing the menus—SUPERIMPOSE	25
Converting S-video signals into composite video signals	
—DOWN MIX	25
Converting composite video signals into S-video signals	
—Y/C SEPARATE	25
Sound adjustments	26
Basic adjustment items	26
Operation through on-screen display menus	26
Menu operation buttons	26
Setup menu configuration	27
Menu operating procedure	28
Adjusting the items	29
Adjusting speaker output level	29
Adjusting the equalization patterns	
—DIGITAL EQ 63Hz/250Hz/1kHz/4kHz/16kHz	30
Adjusting the bass sounds	30
Adjusting the sound parameters for the	
Surround/DSP modes	31
Tuner operations	32
Setting the AM tuner interval spacing	32
Tuning in to stations manually	32
Using preset tuning	32
Selecting the FM reception mode	33
Creating realistic sound fields	34
Reproducing theater ambience	34
Introducing the Surround modes	34
Introducing the DSP modes	37
Using the Surround/DSP modes	38
Activating the Surround/DSP modes	39
AV COMPU LINK remote control system	40
Operating other JVC products	42
Operating other manufacturers' products	44
Troubleshooting	47
Specifications	48

Parts identification



Remote control

See pages in parentheses for details.

- 1 TV DIRECT button (14)
- 2 Source selecting buttons (12, 14, 32, 33)
DVR/DVD, VCR, DBS, TV, DVD MULTI, FM/AM
- 3 Operating buttons for tuner (32, 33)
TUNING, FM MODE, TUNING, MEMORY
- 4 On-screen display operation buttons (18, 26)
Cursor buttons (▶, ◀, ▲, ▼), **SET**
- 5 SMART SURROUND SETUP button (16)
- 6 EX/ES button (22)
- 7 SOUND button (13, 14, 22, 24, 30, 31)
- 8 SURROUND button (39)
- 9 Adjusting buttons for speaker and subwoofer output levels (29)
FRONT L +/-, FRONT R +/-, CENTER +/-, SUBWFR +/-,
SURR L +/-, SURR R +/-, S.BACK +/-
- 10 **PH** AUDIO button (12, 14)
- 11 MUTING button (15)
- 12 VOLUME +/- button (13)
- 13 Mode selector (12, 14, 16, 18, 22, 24, 26, 29 – 32, 39)
DVR, DVD, AUDIO/TV/VCR/DBS
- 14 MENU button (18, 26)
- 15 • Numeric buttons (33)
• Adjusting buttons (13, 14, 24, 30, 31)
DECODE, EQ FREQ, BASS BOOST, C.TONE,
EQ LEVEL, MIDNIGHT, EFFECT, EQ LEVEL, A.POSITION
- 16 DIMMER button (15)
- 17 ANALOG/DIGITAL INPUT button (12)
- 18 TEST TONE button (17, 29)
- 19 SLEEP button (15)

The buttons which are not indicated here can be used for operating other JVC products or other manufacturers' products. For details, see pages 42 to 46.

- When operating this receiver, set the mode selector (13) to "AUDIO/TV/VCR/DBS."
- When operating a JVC DVD recorder, set the mode selector (13) to "DVR."
- When operating a JVC DVD player, set the mode selector (13) to "DVD."

To open the cover of the remote control, push here then slide downward.

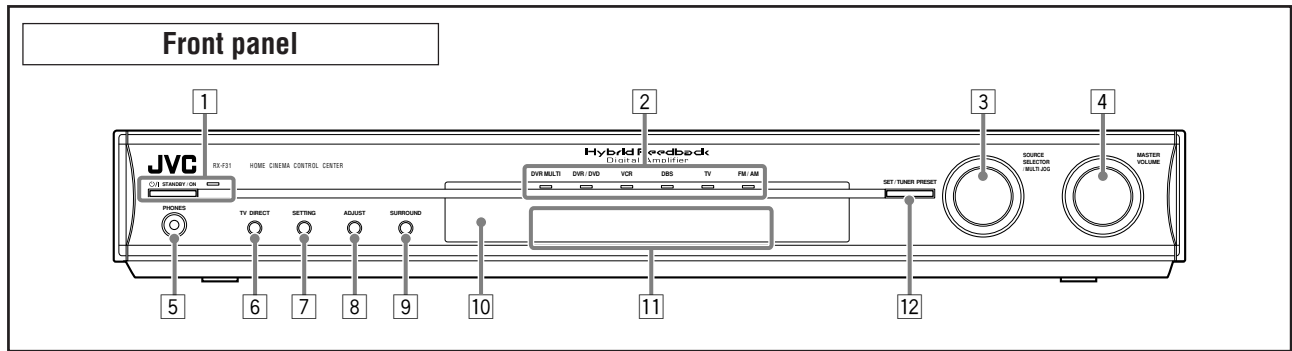

- | | |
|---|---|
| <ul style="list-style-type: none"> 1 Φ/I STANDBY/ON button and standby lamp (12, 14, 32) 2 Source lamps
DVD MULTI, DVR/DVD, VCR, DBS, TV, FM/AM 3 SOURCE SELECTOR (12, 14, 33)
• MULTI JOG (18, 26, 33, 39) 4 MASTER VOLUME control (13) 5 PHONES jack (13) 6 TV DIRECT button (14) | <ul style="list-style-type: none"> 7 SETTING button (18, 32) 8 ADJUST button (26, 32) 9 SURROUND button (39) 10 Remote sensor (4) 11 Display window (see below)
• SET button (17, 18, 26)
• TUNER PRESET button (33) |
|---|---|

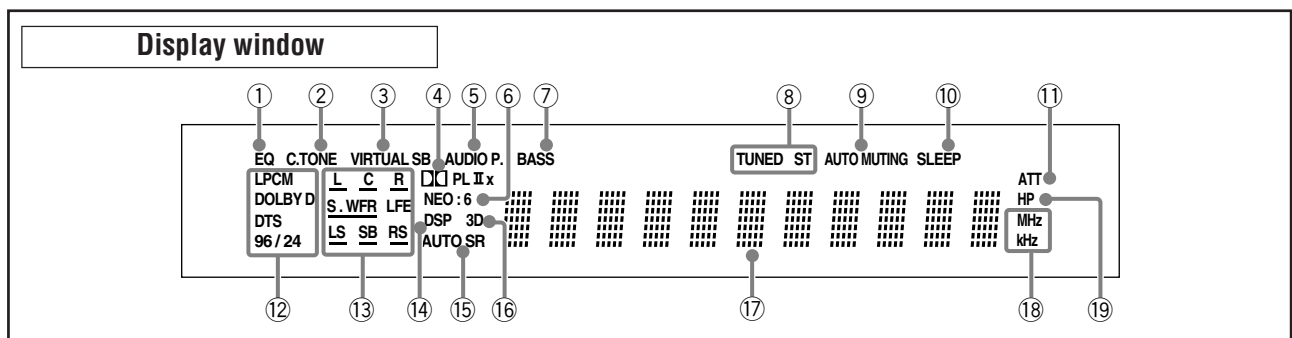

- | | |
|--|---|
| <ul style="list-style-type: none"> 1 EQ indicator (30) 2 C.TONE indicator (31) 3 VIRTUAL SB indicator (38) 4 $\square\square$ PL II and $\square\square$ PL IIx indicator (35) 5 AUDIO P. (position) indicator (14) 6 Neo:6 indicator (36) 7 BASS indicator (30) 8 Tuner operation indicators (32)
TUNED, ST (stereo) 9 AUTO MUTING indicator (33) 10 SLEEP indicator (15) | <ul style="list-style-type: none"> 11 ATT (attenuator) indicator (30) 12 Digital signal format indicators (13, 34 – 36)
LPCM (Linear PCM), DOLBY D (Dolby Digital), DTS, 96/24 13 Signal and speaker indicators (15) 14 DSP indicator (36, 37) 15 AUTO SR (surround) indicator (39) 16 3D indicator (36, 37) 17 Main display 18 Frequency unit indicators
MHz (for FM station), kHz (for AM station) 19 HP (headphones) indicator (13, 36, 37) |
|--|---|

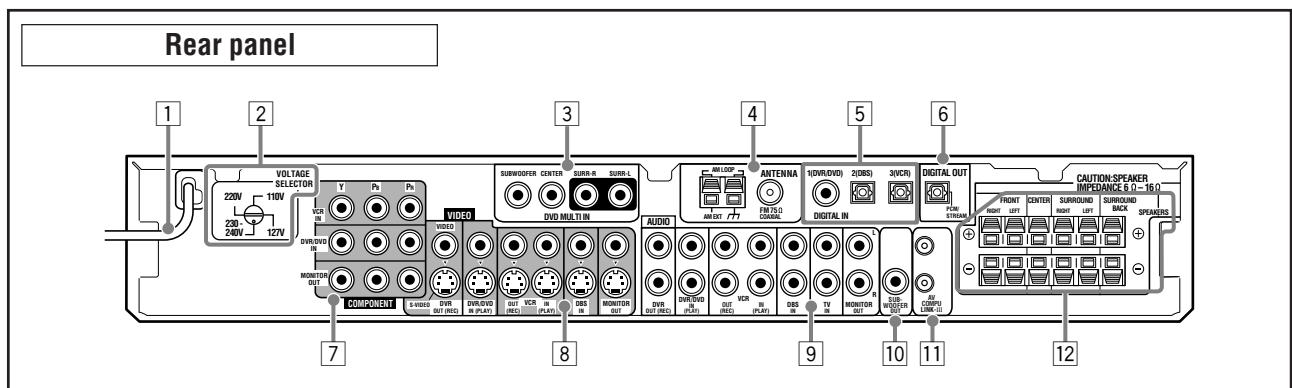

- | | |
|--|--|
| <ul style="list-style-type: none"> 1 Power cord (11) 2 VOLTAGE SELECTOR (4) 3 DVD MULTI IN jacks (8)
SUBWOOFER, CENTER, SURR-R, SURR-L 4 ANTENNA terminals (5) 5 DIGITAL IN terminals (11)
• Coaxial: 1(DVR/DVD)
• Optical: 2(DBS), 3(VCR) 6 DIGITAL OUT terminal (11) 7 COMPONENT (Y, Pb, Pr) jacks (7 – 10)
VCR IN, DVR/DVD IN, MONITOR OUT | <ul style="list-style-type: none"> 8 VIDEO terminals (7 – 10)
VIDEO (composite video) jacks, S-VIDEO terminals
• Input: DVR/DVD IN (PLAY), VCR IN (PLAY), DBS IN
• Output: DVR OUT (REC), VCR OUT (REC), MONITOR OUT 9 AUDIO jacks (7 – 10)
• Input: DVR/DVD IN (PLAY), VCR IN (PLAY), DBS IN, TV IN
• Output: DVR OUT (REC), VCR OUT (REC), MONITOR OUT 10 SUBWOOFER OUT jack (6) 11 AV COMPU LINK-III terminals (40) 12 SPEAKERS terminals (6)
FRONT, CENTER, SURROUND, SURROUND BACK |
|--|--|

Getting started

Before Installation

General precautions

- Be sure your hands are dry.
- Turn the power off to all components.
- Read the manuals supplied with the components you are going to connect.

Locations

- Install the receiver in a location that is level and protected from moisture and dust.
- The temperature around the receiver must be between -5°C and 35°C .
- Make sure there is good ventilation around the receiver. Poor ventilation could cause overheating and damage the receiver.
- Leave sufficient distance between the receiver and the TV.

Handling the receiver

- Do not insert any metal object into the receiver.
- Do not disassemble the receiver or remove screws, covers, or cabinet.
- Do not expose the receiver to rain or moisture.
- Do not pull on the power cord to unplug the cord. When unplugging the cord, always grasp the plug so as not to damage the cord.
- When you are away on travel or otherwise for an extended period or time, remove the plug from the wall outlet. A small amount of power is always consumed while the power cord is connected to the wall outlet.

The receiver has a built-in cooling fan which operates while the receiver is turned on. Be sure to leave enough ventilation to obtain sufficient cooling effect.

CAUTION:

Do not connect the AC power plug to the wall outlet until all connections are completed.

Checking the supplied accessories

Check to be sure you have all of the following supplied accessories. If anything is missing, contact your dealer immediately.

- Remote control (× 1)
- Batteries (× 2)
- AM loop antenna (× 1)
- FM antenna (× 1)
- Digital coaxial cable (× 1)
- AC plug adaptor (× 1)

Putting batteries in the remote control

Before using the remote control, put two supplied batteries first.

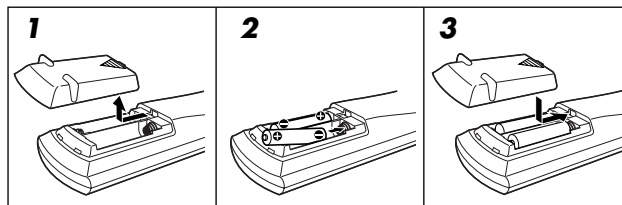

1 Press and slide the battery cover on the back of the remote control.

2 Insert batteries.

Make sure to match the polarity: (+) to (+) and (-) to (-).

3 Replace the cover.

If the range or effectiveness of the remote control decreases, replace the batteries. Use two R6(SUM-3)/AA(15F) type dry-cell batteries.

- Supplied batteries are for initial setup. Replace for continued use.

CAUTION:

Follow these precautions to avoid leaking or cracking cells:

- Place batteries in the remote control so they match the polarity: (+) to (+) and (-) to (-).
- Use the correct type of batteries. Batteries that look similar may differ in voltage.
- Always replace both batteries at the same time.
- Do not expose batteries to heat or flame.

When using the remote control, aim the remote control directly at the remote sensor on the front panel.

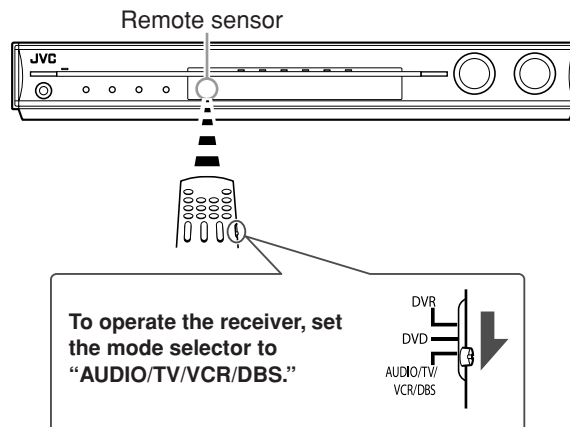

Connecting the FM and AM antennas

Do not connect the AC power plug to the wall outlet until all connections are completed.

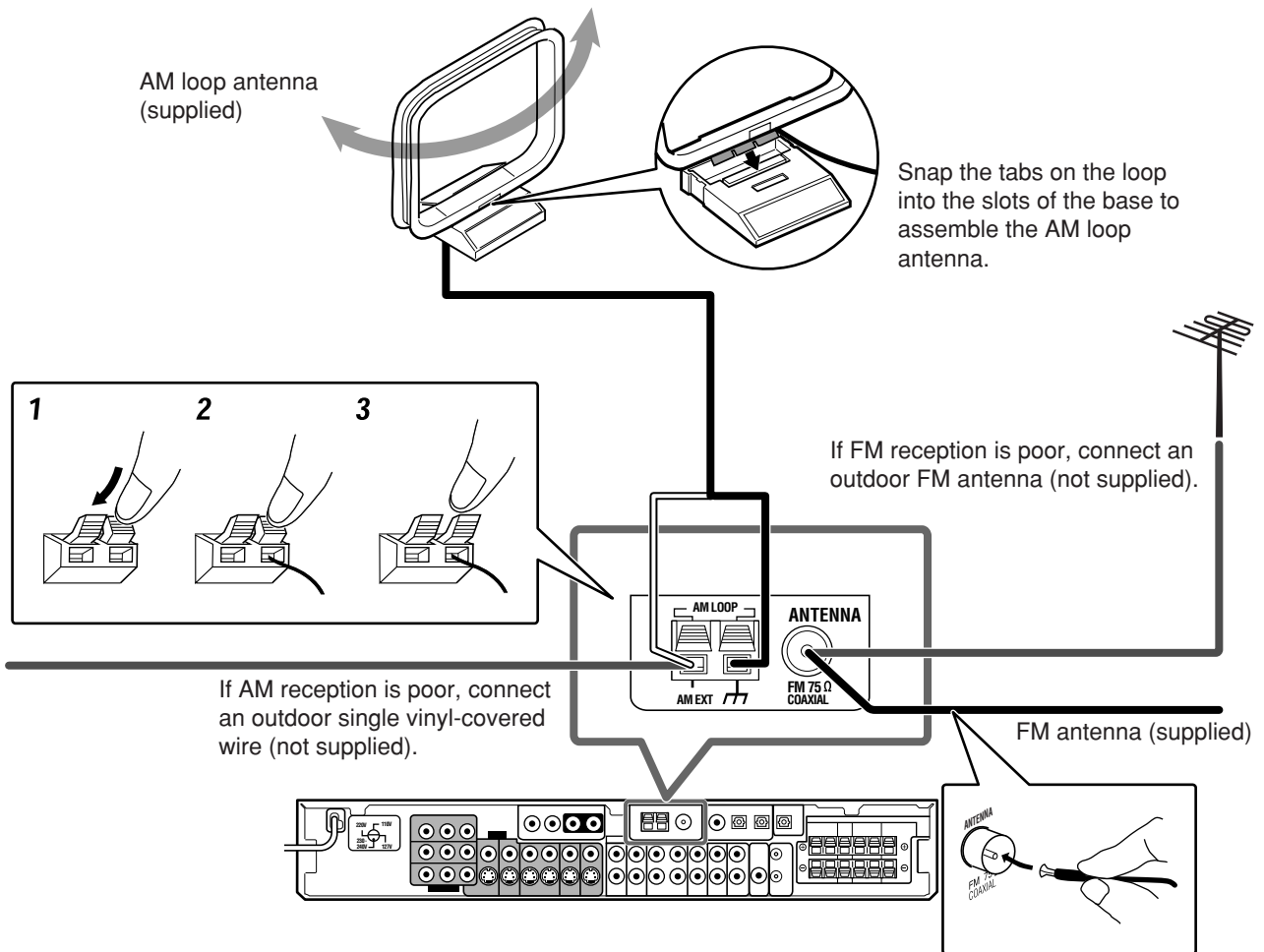

AM antenna connection

Connect the AM loop antenna supplied to the AM LOOP terminals.

Connect the white cord to the AM EXT terminal, and connect the black cord to the ⏏ terminal.

Turn the loop until you have the best reception.

- If the reception is poor, connect an outdoor single vinyl-covered wire (not supplied) to the AM EXT terminal. Keep the AM loop antenna connected.

FM antenna connection

Connect the FM antenna supplied to the FM 75 Ω COAXIAL terminal as a temporary measure.

Extend the supplied FM antenna horizontally.

- If the reception is poor, connect an outdoor FM antenna (not supplied). Before attaching a 75 Ω coaxial cable with a connector (IEC or DIN 45325), disconnect the supplied FM antenna.

NOTES

- If the AM loop antenna wire is covered with vinyl, remove the vinyl while twisting it as shown on the right.
- Make sure the antenna conductors do not touch any other terminals, connecting cords and power cord. This could cause poor reception.

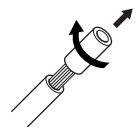

Connecting the speakers

Do not connect the AC power plug to the wall outlet until all connections are completed.

Speaker Layout Diagram

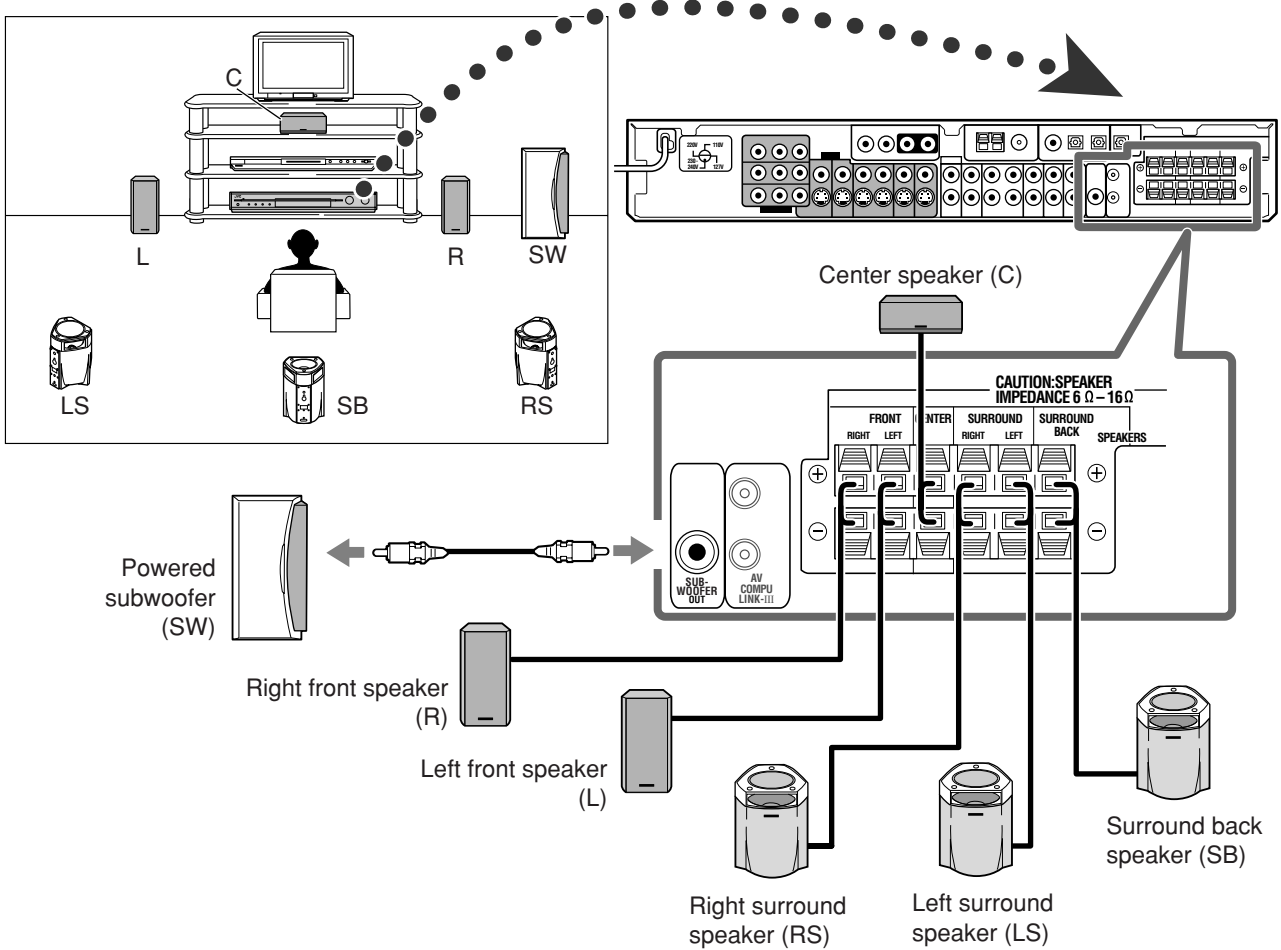

Connecting the speakers

Turn off all components before making connections.

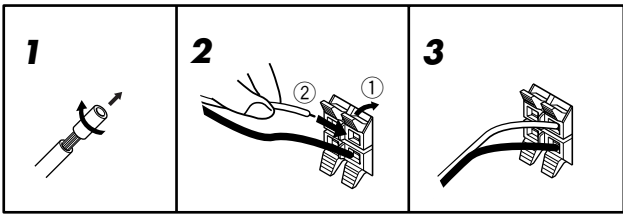

- 1** Twist and remove the insulation at the end of each speaker cord.
- 2** Press and hold the clamp of the speaker terminal (①), then insert the speaker cord (②).
 - For each speaker, connect the (+) and (-) terminals on the rear panel to the (+) and (-) terminals marked on the speakers.
- 3** Release the finger from the clamp.

CAUTIONS:

- Use speakers with the SPEAKER IMPEDANCE indicated by the speaker terminals (6 Ω – 16 Ω).
- DO NOT connect more than one speaker to one speaker terminal.

Connecting the powered subwoofer

By connecting a subwoofer, you can enhance the bass or reproduce the original LFE signals recorded in digital software.

Connect the input jack of a powered subwoofer to the SUBWOOFER OUT jack on the rear panel, using a cord with RCA pin plugs (not supplied).

- Refer also to the manual supplied with your subwoofer.

After connecting all the speakers and/or a subwoofer, set the speaker setting information properly to obtain the best possible surround effect. For details, see pages 16, 17, and 21 to 23.

NOTE

You can place a subwoofer wherever you like since bass sound is non-directional. Normally place it in front of you.

Connecting video components

Do not connect the AC power plug to the wall outlet until all connections are completed.

This receiver is equipped with the following video terminals—composite video, S-video, and component video terminals.

- If your video components have S-video (Y/C-separation) and/or component video (Y, P_B, P_R) jacks, connect them using an S-video cable (not supplied) or component video cable (not supplied). By using these terminals, you can get a better picture quality in the order:

Component > S-video > Composite

IMPORTANT:

Component video signals are transmitted only through component video output jacks. Therefore, if a recording video component and a playing video component are connected to the receiver through the video terminals of different type, you cannot record the picture. In addition, if the TV and a playing video component are connected to the receiver through the video terminals of different type, you cannot view the playback picture on the TV. On the other hand, S-video signals and composite video signals can be converted into each other and transmitted through the corresponding output jack. For details about the settings of the conversion, see page 25.

Turn off all components before making connections.

- When you connect other components, refer also to their manuals.

DO NOT use a TV through a VCR or a TV with a built-in VCR; otherwise, the picture may be distorted.

CAUTION:

If you connect a sound-enhancing device such as a graphic equalizer between the source components and this receiver, the sound output through this receiver may be distorted.

If your video components have AV COMPU LINK terminal

See also page 40 for detailed information about the connection and the AV COMPU LINK remote control system.

■ Connecting a DVD recorder or DVD player with its stereo output jacks (DVR/DVD):

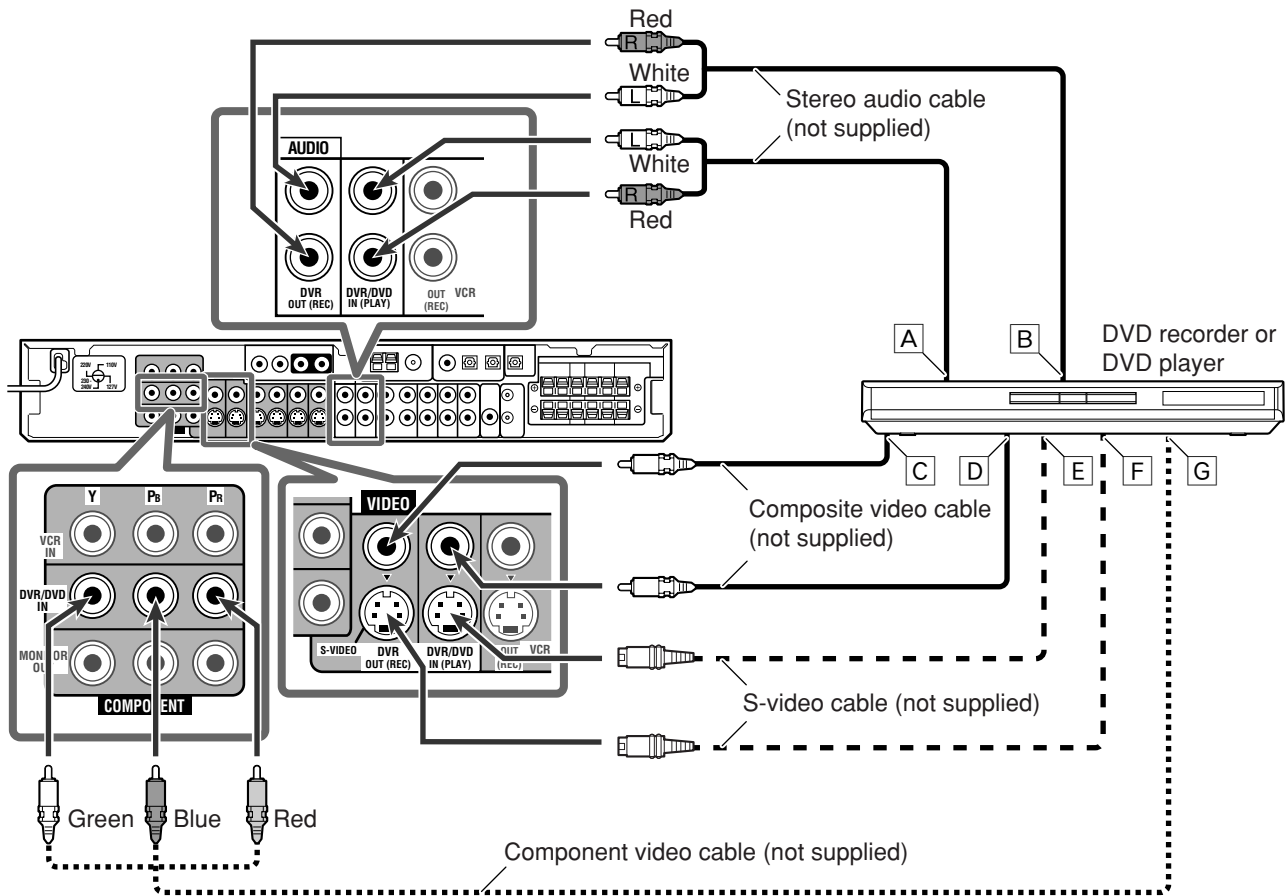

NOTES

- When connecting a DVD recorder or DVD player to the component video input jacks, make the component video input setting (DVD VIDEO INPUT) correctly. If you do not, you cannot view the playback picture on the TV or the AV COMPU LINK remote control system cannot operate properly. For details, see page 25.
- You can enjoy digital sound if using a digital coaxial or optical cable. When shipped from the factory, the audio input mode for a DVD recorder and DVD player is set to use the digital coaxial terminal (DIGITAL IN 1 (DVR/DVD)). For details of digital connection, see page 11.

- A To left/right audio channel output
- B **Only for DVD recorder:** To left/right audio channel input
- C **Only for DVD recorder:** To composite video input
- D To composite video output
- E To S-video output
- F **Only for DVD recorder:** To S-video input
- G To component video output
 - Connect Y, P_B, and P_R correctly.

■ Connecting a DVD recorder or DVD player with its analog discrete output jacks (DVD MULTI IN):

This connection is the best connection method for enjoying DVD Audio sounds. When a DVD Audio disc is played back, the original high-quality sounds can be reproduced only using this connection.

Turn off all components before making connections.

- When you connect other components, refer also to their manuals.

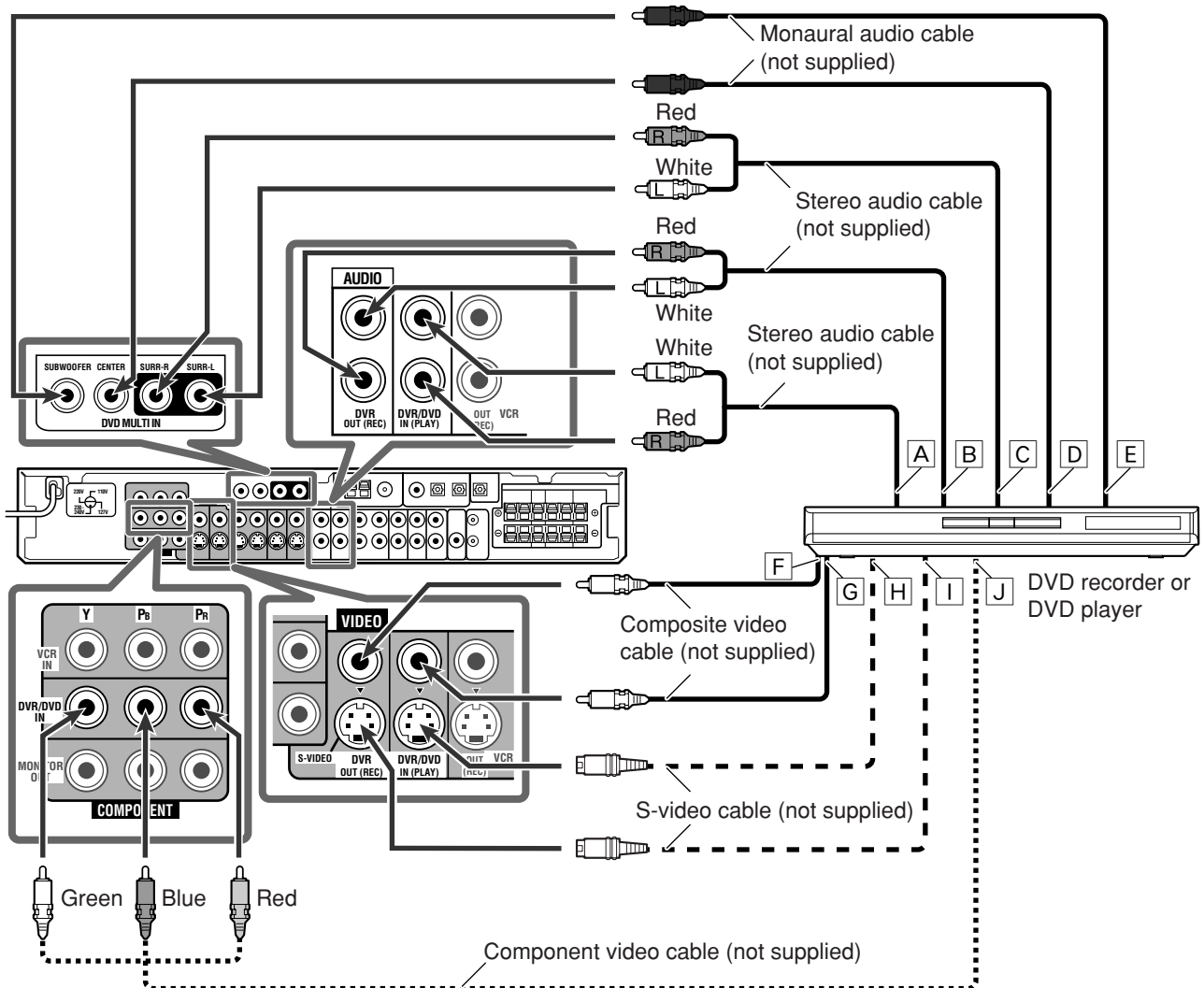

NOTE

When connecting a DVD recorder or DVD player to the component video input jacks, make the component video input setting (DVD VIDEO INPUT) correctly. If you do not, you cannot view the playback picture on the TV or the AV COMPU LINK remote control system cannot operate properly. For details, see page 25.

- A To left/right front channel audio output
 - B **Only for DVD recorder:** To left/right front channel audio input
 - C To left/right surround channel audio output
 - D To center channel audio output
 - E To subwoofer output
 - F **Only for DVD recorder:** To composite video input
 - G To composite video output
 - H To S-video output
 - I **Only for DVD recorder:** To S-video input
 - J To component video output
- Connect Y, Pb, and Pr correctly.

About "DVD MULTI"

When you select "DVD MULTI" as the source (see page 12), you can enjoy analog discrete output sound (5.1-channel reproduction) from the connected component.

- You may need to select analog discrete output mode on the component.

NOTES

- When using the headphones, you can listen to the front channel sounds (left and right) only. 3D HEADPHONE mode (see pages 36 and 37) is not available.
- When TV Direct is activated while "DVD MULTI" is selected as the source, the source changes to the last selected source—"DVR/DVD," "VCR," and "DBS" (see page 14).
- Surround/DSP modes (see pages 34 to 39) are not available for "DVD MULTI."

■ Connecting a VCR

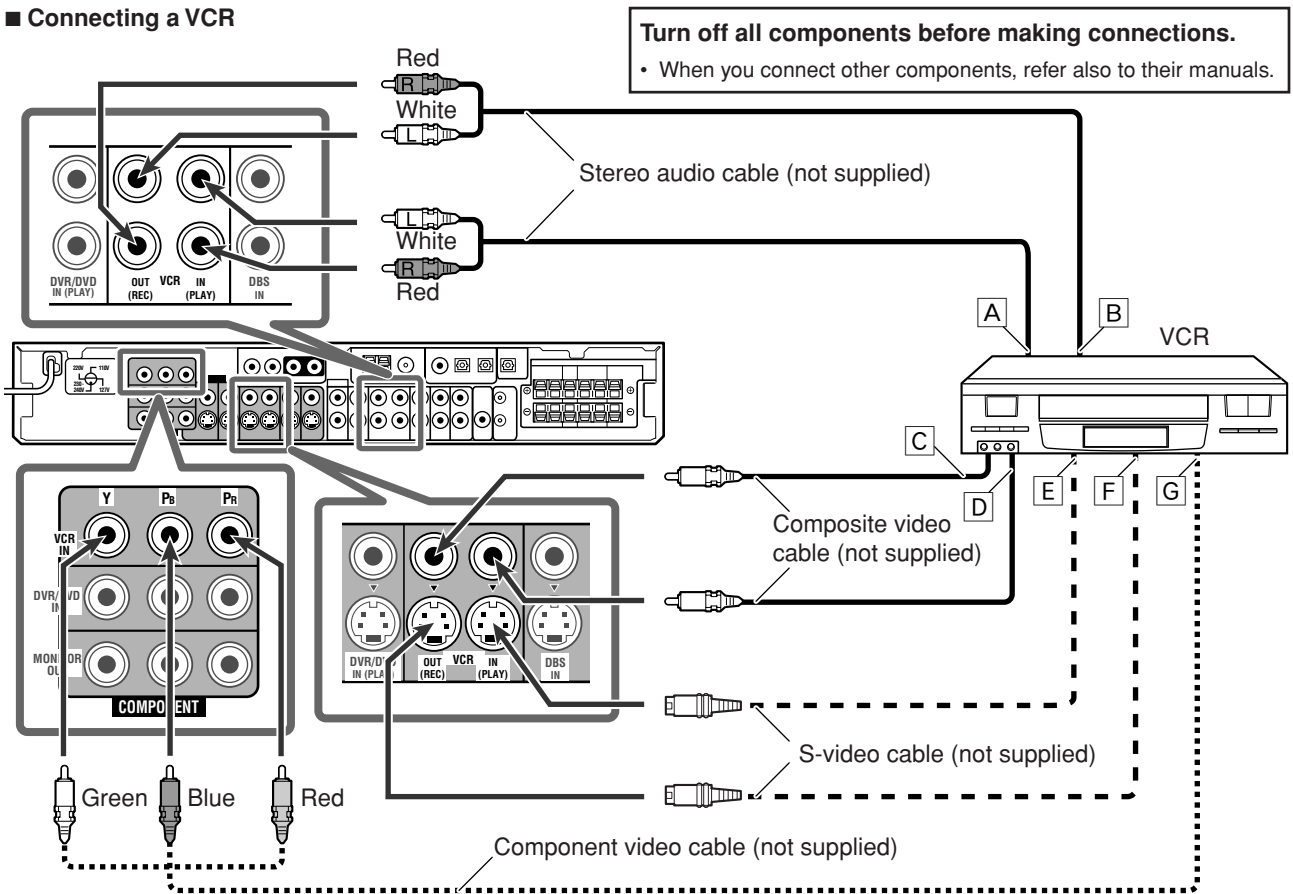

NOTES

- When connecting a VCR to the component video input jacks, make the component video input setting (VCR VIDEO INPUT) correctly. If you do not, you cannot view the playback picture on the TV or the AV COMPU LINK remote control system cannot operate properly. For details, see page 25.
- You can enjoy digital sound if using a digital coaxial or optical cable. When shipped from the factory, the audio input mode for a video component other than DVD recorder and DVD player is set to use the digital optical terminal (DIGITAL IN 3 (VCR)). For details of digital connection, see page 11.

- A To left/right audio channel output
 - B To left/right audio channel input
 - C To composite video input
 - D To composite video output
 - E To S-video output
 - F To S-video input
 - G To component video output
- Connect Y, Pb, and Pr correctly.

■ Connecting a DBS tuner

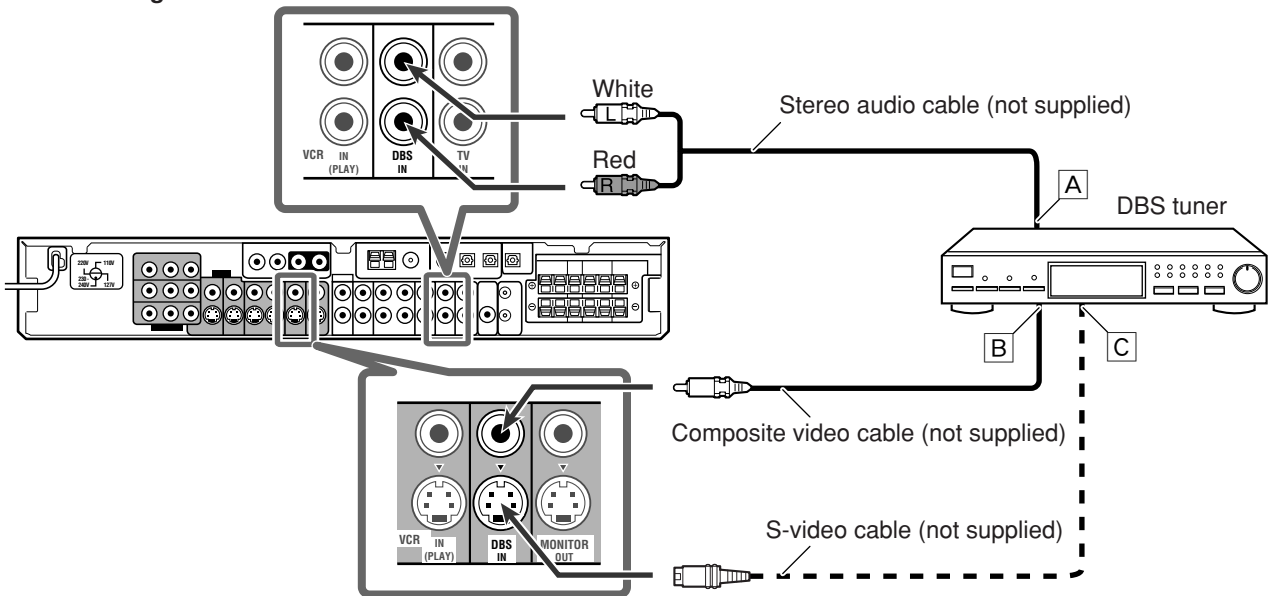

NOTE

You can enjoy digital sound if using a digital coaxial or optical cable. When shipped from the factory, the audio input mode for a TV is set to use the digital optical terminal (DIGITAL IN 2 (DBS)). For details of digital connection, see page 11.

- A To left/right audio channel output
- B To composite video output
- C To S-video output

■ Connecting a TV

Connect the TV to the appropriate MONITOR OUT jacks to view the playback picture from any other connected video components.

Turn off all components before making connections.

- When you connect other components, refer also to their manuals.

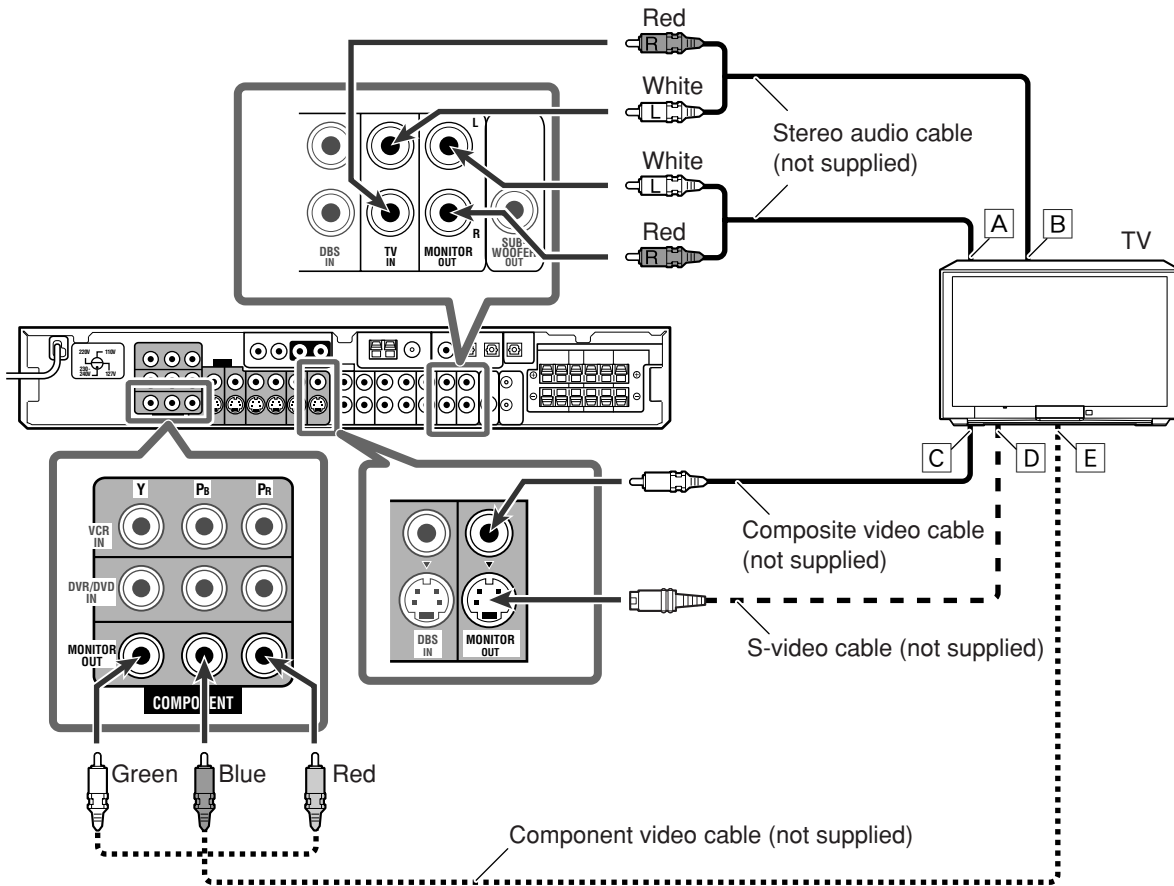

NOTES

- You can enjoy digital sound if using a digital coaxial or optical cable. For details of digital connection, see page 11.
- When connecting a TV through the COMPONENT MONITOR OUT jacks, the on-screen display does not appear on the TV screen (see page 25).

- A To left/right audio channel input
 - B To left/right audio channel output
 - C To composite video input
 - D To S-video input
 - E To component video input
- Connect Y, P_B, and P_R correctly.

IMPORTANT:

Audio signals come out through the MONITOR OUT (L/R) jacks ONLY when TV Direct is in use (see page 14). Connect these jacks to the audio input jacks corresponding to the video connection; otherwise, no sound comes out of the TV speaker when TV Direct is in use.

Digital connection

This receiver is equipped with three DIGITAL IN terminals—one digital coaxial terminal and two digital optical terminals—and one DIGITAL OUT terminal.

To reproduce the digital sound, use the digital connection in addition to the analog connection methods described on pages 7 to 10.

Digital coaxial cable (supplied: 1 cable)



Digital optical cable (not supplied)



Turn off all components before making connections.

- When you connect other components, refer also to their manuals.

Digital input terminals

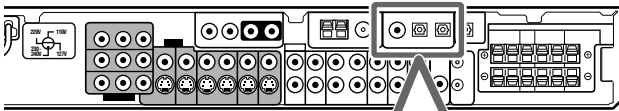

When the component has a digital coaxial output terminal, connect it to the 1(DVR/DVD) terminal, using a digital coaxial cable (supplied).

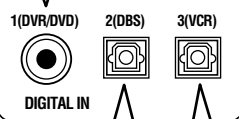

When the component has a digital optical output terminal, connect it to the 2(DBS) or 3(VCR) terminal, using a digital optical cable (not supplied).

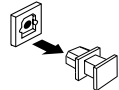

Before connecting a digital optical cable, unplug the protective plug.

NOTES

- When shipped from the factory, the DIGITAL IN terminals have been set for use with the following components:
 - 1(DVR/DVD): For DVD recorder or DVD player
 - 2(DBS): For DBS tuner
 - 3(VCR): For VCR
- If you connect other components, change the digital input (DIGITAL IN) terminal setting correctly. See "Setting the digital input (DIGITAL IN) terminals—DIGITAL IN 1/2/3" on page 24.
- Select the digital input mode. See "Selecting the analog or digital input mode" on page 12.
- When you want to operate the connected component (except DBS tuner) using the AV COMPU LINK remote control system (see pages 40 and 41), connect them also as described on pages 7 to 10.

Digital output terminal

You can connect any digital components which have an optical digital input terminal.

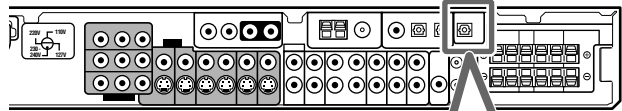

Connecting digital recording equipment to the DIGITAL OUT terminal enables you to perform digital-to-digital recording.

NOTE

The digital signal format transmitted through the DIGITAL OUT terminal is the same as that of the input signal. For example, when the DTS signals are input, the DTS signals are transmitted.

Connecting the power cord

When all the audio/video connections have been made, connect the AC power plug to the wall outlet. Make sure that the plugs are inserted firmly. The standby lamp lights in red.

CAUTIONS:

- Do not plug in before setting the VOLTAGE SELECTOR switch on the rear of the receiver and all connection procedures are complete.
- Do not touch the power cord with wet hands.
- Do not alter, twist or pull the power cord, or put anything heavy on it, which may cause fire, electric shock, or other accidents.
- If the cord is damaged, consult a dealer and have the power cord replaced with a new one.

NOTES

- Keep the power cord away from the connecting cables and the antenna. The power cord may cause noise or screen interference.
- The preset settings such as preset channels and sound adjustment may be erased in a few days in the following cases:
 - When you unplug the power cord.
 - When a power failure occurs.
- If the wall outlet does not match the AC plug, use the supplied AC plug adaptor.

Basic operations

The on-screen display appears on the TV screen for 5 seconds (except "turning off the sounds temporarily") to show the indication in the following cases:

- When you select the source (see right column).
- When you adjust the volume (see page 13).
- When you turn off the sounds temporarily (see page 15).
- When you select the Surround/DSP modes (see page 39).

To cancel the function, set "SUPERIMPOSE" to "SUPERIMPOSE: OFF" (see page 25).

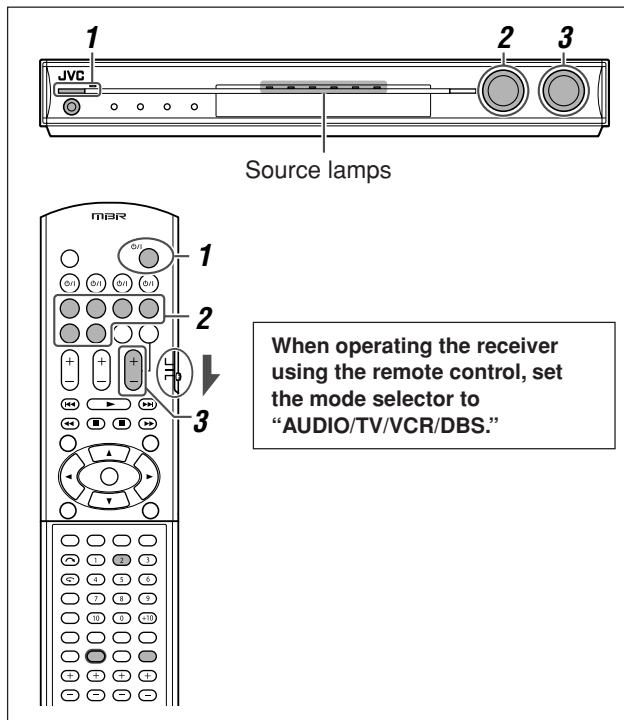

1 Turn on the power

Press **STANDBY/ON** (or **AUDIO** on the remote control).

The standby lamp goes off and the source lamp of the current source lights in red.

Current source name appears.

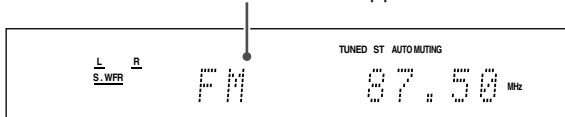

To turn off the power (into standby)

Press **STANDBY/ON** (or **AUDIO** on the remote control) again.

The standby lamp lights in red.

NOTE

A small amount of power is consumed in standby mode. To turn the power off completely, unplug the AC power cord.

2 Select the source to play

On the front panel:

Turn **SOURCE SELECTOR** until the source name you want appears on the display.

The source lamp corresponding to the selected source lights in red.

- As you turn **SOURCE SELECTOR**, the source changes as follows:

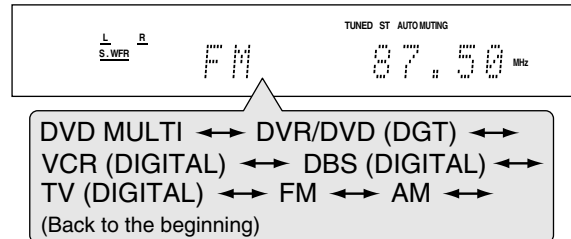

DVD MULTI:	Select for the DVD player using the analog discrete output mode (5.1-channel reproduction).
DVR/DVD (DGT)*:	Select for the DVD recorder or DVD player.
VCR (DIGITAL)*:	Select for the VCR.
DBS (DIGITAL)*:	Select for the DBS tuner.
TV (DIGITAL)*:	Select for the TV.
FM:	Select for an FM broadcast.
AM:	Select for an AM broadcast.

From the remote control:

Press one of the source selecting buttons.

- For the tuner, press **FM/AM**. Each time you press **FM/AM**, the band alternates between "FM" and "AM."

* Selecting the analog or digital input mode

For a component you have connected using both the analog connection and the digital connection methods (see pages 7 to 11), you need to select the correct input mode.

- You can select the digital input only for sources which you have selected digital input terminals for. (See "Setting the digital input (DIGITAL IN) terminals—DIGITAL IN 1/2/3" on page 24.)

From the remote control ONLY:

Press **ANALOG/DIGITAL INPUT** to select the analog or digital input mode.

- Each time you press the button, the input mode alternates between the analog input ("ANALOG") and the digital input ("DGTL AUTO").

This setting is memorized for each source.

DGTL AUTO: Select for the digital input mode. The receiver automatically detects the incoming signal format, then the digital signal format indicator (LPCM, DOLBY D, DTS, or DTS 96/24) for the detected signal lights up.

ANALOG: Select for the analog input mode.

Initial setting: DGTL AUTO

NOTE

When you select "DVD MULTI," "FM," or "AM" as the source, the analog and digital input mode is not available.

3 Adjust the volume

To increase the volume, turn **MASTER VOLUME** control clockwise (or press **VOLUME +** on the remote control).

To decrease the volume, turn **MASTER VOLUME** control counterclockwise (or press **VOLUME –** on the remote control).

- When you adjust the volume, the volume level indication appears on the display for a while.

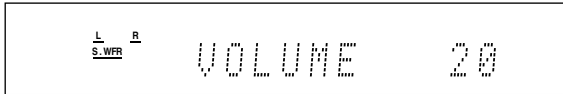

CAUTION:

Always set the volume to the minimum before starting any sources. If the volume is set at its high level, the sudden blast of sound energy can permanently damage your hearing and/or ruin your speakers.

NOTE

The volume level can be adjusted within the range of “0” (minimum) to “50” (maximum).

Listening with headphones

You can enjoy not only stereo software but also multi-channel software through the headphones. (Sounds are down-mixed to the front channels while playing multi-channel software.)

Connect a pair of headphones to the PHONES jack on the front panel to activate the HEADPHONE mode.

The HP (headphone) indicator lights up on the display.

- You can also enjoy the Surround/DSP mode through the headphones—3D HEADPHONE mode. For details, see pages 36 and 37.
- Disconnecting a pair of headphones from the PHONES jack cancels the HEADPHONE (or 3D HEADPHONE) mode and activates the speakers.

CAUTION:

Be sure to turn down the volume:

- Before connecting or putting on headphones, as high volume can damage both the headphones and your hearing.
- Before removing headphones, as high volume may output from the speakers.

Selecting the digital decode mode

If the following symptoms occur while playing Dolby Digital or DTS software with “DGTL AUTO” selected (see page 12), follow the procedure below:

- Sound does not come out at the beginning of playback.
- Noise comes out while searching for or skipping chapters or tracks.

From the remote control ONLY:

Press SOUND, then press DECODE to select “DOLBY D” or “DTS.”

- Each time you press DECODE, the digital decode mode changes as follows:

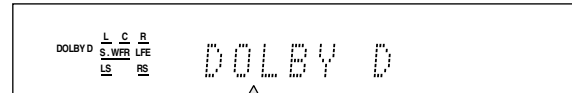

DGTL AUTO → DOLBY D →
DTS → (Back to the beginning)

- To play back software encoded with Dolby Digital, select “DOLBY D.”
- To play back software encoded with DTS, select “DTS.”

NOTES

- When you turn off the power or select another source, “DOLBY D” or “DTS” is canceled and the digital decode mode is automatically reset to “DGTL AUTO.”
- After pressing SOUND, the numeric buttons work for sound adjustments. To use the numeric buttons to operate your target source, press the corresponding source selecting button before operation; otherwise, the remote control may not work as you intend.

The following digital signal format indicators on the display indicate what type of signal comes into the receiver.

LPCM: Lights up when Linear PCM signal comes in.

DOLBY D:

- Lights up when Dolby Digital signal comes in.
- Flashes when “DOLBY D” is selected for any software other than Dolby Digital.

DTS:

- Lights up when conventional DTS signal comes in.
- Flashes when “DTS” is selected for any software other than DTS.

DTS 96/24: Lights up when DTS 96/24 signal comes in.

NOTE

When “DGTL AUTO” cannot recognize the incoming signal, no digital signal format indicator lights up on the display.

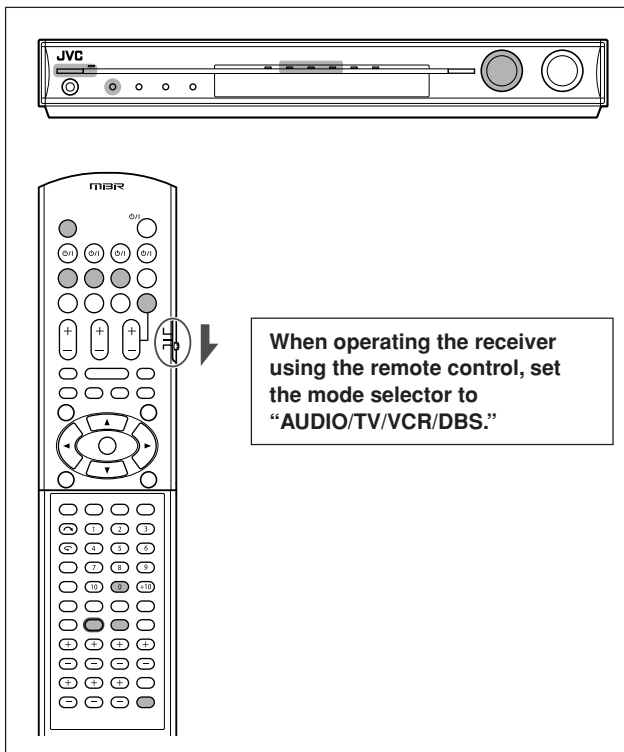

Adjusting the subwoofer audio position

If the subwoofer sound is much reinforced for stereo sound compared to the sound reproduced with multi-channel, set the subwoofer audio position. The subwoofer output level is automatically decreased by the selected value when you are listening in stereo.

The AUDIO P. indicator lights up when this function is activated.

- Once you have made an adjustment, it is memorized for each source.

From the remote control ONLY:

Press SOUND, then press A.POSITION repeatedly.

- Each time you press A.POSITION, the subwoofer audio position level changes as follows:

AUDIO P. indicator

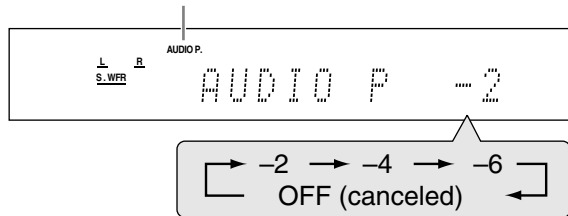

The smaller the number becomes, the more the level decreases automatically when listening in stereo.

- If no adjustment is required, select "OFF" (initial setting).

NOTES

- The minimum subwoofer output level is -10 dB.
Ex.: When setting the subwoofer output level to " -8 (dB)" and the subwoofer audio position to " -4 (dB)," the subwoofer output level when listening in stereo will be -10 dB.
To adjust the subwoofer output level, see page 29.
- This function is not available when the Surround/DSP mode is activated or "DVD MULTI" is selected.
- After pressing SOUND, the numeric buttons work for sound adjustments. To use the numeric buttons to operate your target source, press the corresponding source selecting button before operation; otherwise, the remote control may not work as you intend.

Activating TV Direct

TV Direct enables you to use this receiver as an AV selector **while the receiver is turned off.**

When TV Direct is activated, the pictures and sounds go from the video components such as DVD player to the TV through this receiver. Thus, you can use the video components and the TV as if they were connected directly.

- This function takes effect for the following sources—DVR/DVD, VCR, and DBS.

To activate (or deactivate) TV Direct, follow the procedure below:

1 Press TV DIRECT.

All the indications disappear, then the source lamp of the current source lights in green.

2 Turn on the video component and TV.

3 Select the target video component.

On the front panel:

Turn SOURCE SELECTOR until one of the source lamps—DVR/DVD, VCR, or DBS—lights in green.

From the remote control:

Press one of the source selecting buttons—DVR/DVD, VCR, or DBS.

The source lamp corresponding to the selected source lights in green.

To cancel TV Direct and turn off the receiver, press \odot /I STANDBY/ON on the front panel (or \odot /I AUDIO on the remote control).

The receiver is turned off and the standby lamp lights up.

To cancel TV Direct and turn on the receiver, press TV DIRECT again.

The receiver is turned on and the source lamp currently selected lights in red.

NOTES

- When TV Direct is activated, you cannot enjoy any of the sound effects the receiver produces, and cannot use the speakers connected to the receiver.
- When TV Direct is activated while "DVD MULTI," "FM," or "AM" is selected as the source, the source changes to the last selected source—"DVR/DVD," "VCR," or "DBS."

Turning off the sounds temporarily

From the remote control ONLY:

Press **MUTING** to turn off the sound through all connected speakers and headphones.

"MUTING" appears on the display and the volume turns off.



To restore the sound, press **MUTING** again.

- Pressing **VOLUME +/-** (or turning **MASTER VOLUME** control on the front panel) also restores the sound.

Changing the display brightness

You can dim the display—Dimmer.

From the remote control ONLY:

Press **DIMMER** repeatedly.

- Each time you press the button, the display brightness changes as follows:

- DIMMER 1: Dims the display slightly.
Dims the blue illumination slightly.
- DIMMER 2: Dims the display more than DIMMER 1.
Dims the blue illumination slightly (more than DIMMER 1).
- DIMMER 3: Turns off the display and blue illumination.
(Temporarily canceled when you operate the receiver.*)
- DIMMER OFF: Cancels the Dimmer (normal display).

* Except when activating or deactivating TV Direct.

Turning off the power with the Sleep Timer

You can fall asleep while listening to music—Sleep Timer.

From the remote control ONLY:

Press **SLEEP** repeatedly.

- Each time you press the button, the shut-off time changes in 10 minute intervals. The **SLEEP** indicator lights up on the display.

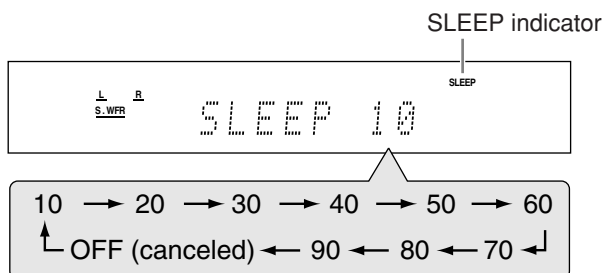

When the shut-off time comes:

The receiver turns off automatically.

To check or change the remaining time until the shut-off time:

Press **SLEEP** once.

The remaining time (in minutes) until the shut-off time appears.

- To change the shut-off time, press **SLEEP** repeatedly.

To cancel the Sleep Timer:

Press **SLEEP** repeatedly so that "SLEEP OFF" appears on the display. (The **SLEEP** indicator goes off.)

- The Sleep Timer is also canceled when:
 - You turn off the receiver, or
 - TV Direct is activated.

Basic adjustment of auto memory

This receiver memorizes sound settings for each source:

- when you turn off the power, and
- when you change the source.

When you change the source, the memorized settings for the newly selected source are automatically recalled.

The following can be stored for each source:

- Analog/digital input mode (see page 12)
- Subwoofer audio position (see page 14)
- Midnight mode (see page 24)
- Speaker output level (see page 29)
- Digital equalization pattern (see page 30)
- Bass boost (see page 30)
- Subwoofer phase (see page 30)
- Input attenuator mode (see page 30)
- Surround/DSP mode selection (see page 39)

NOTE

If the source is "FM" or "AM," you can assign a different setting for each band.

Signal and speaker indicators on the display

Signal indicators

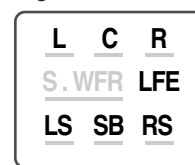

Speaker indicators

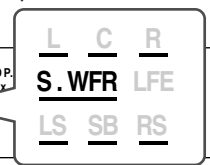

The signal indicators light up as follows:

- L:
 - **When digital input is selected:** Lights up when the left channel signal comes in.
 - **When analog input is selected:** Always lights up.
- R:
 - **When digital input is selected:** Lights up when the right channel signal comes in.
 - **When analog input is selected:** Always lights up.
- C: Lights up when the center channel signal comes in.
- LS*: Lights up when the left surround channel signal comes in.
- RS*: Lights up when the right surround channel signal comes in.
- SB: Lights up when the surround back channel signal comes in.
- LFE: Lights up when the LFE channel signal comes in.

* When monaural surround signal comes in, only "S" lights up.

NOTE

When "DVD MULTI" is selected as the source, all the signal indicators except "SB" light up.

The speaker indicators light up as follows:

- The subwoofer indicator (**S.WFR**) lights up when "SUBWOOFER" is set to "SUBWOOFER: YES." For details, see page 21.
- The other speaker indicators light up only when the corresponding speaker is set to "SMALL" or "LARGE," and also when required for the current playback.

Basic settings

To obtain the best possible sound effect from Surround/DSP modes (see pages 34 to 39), you need to set up the speaker and subwoofer information after all the connections are completed. From pages 16 to 25, how to set speakers and other basic items of the receiver are explained.

Setting the speaker information automatically—Smart Surround Setup

The distance from your listening point to the speakers is one of the important elements to obtain the best possible sound effect from the Surround/DSP modes.

By using Smart Surround Setup, the following are automatically calculated by one simple action—clapping hands.

- Speaker distance (compared to that of the closest speaker)
- Speaker output level (except the subwoofer)

NOTES

- Before starting Smart Surround Setup, set the speaker information correctly (SMALL, LARGE, or NO) according to your speakers except the subwoofer (see page 21).
- The speakers which are set to “NO” in the speaker setting (see page 21) are not indicated clearly on the TV screen.
- When the setting is made by Smart Surround Setup, the speaker distance and output level you have set before will be inactive.
- You can see the setting process on the TV screen and the display during Smart Surround Setup. If you have turned off the display, cancel the Dimmer (see page 15); otherwise, you cannot see the information on the display.
- Smart Surround Setup will not be done correctly if you or other object blocks the sound.
- When you change your speakers, do the following procedure again.

In this section, the on-screen display on the TV screen is used for explaining.

- The on-screen display does not appear on the TV screen when connecting the TV through the COMPONENT MONITOR OUT jacks (see page 10).

From the remote control ONLY:

When operating the receiver using the remote control, set the mode selector to “AUDIO/TV/VCR/DBS.”

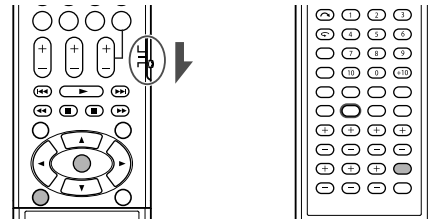

1 Take your position where you listen to the sound.

- Make sure speaker cables are connected firmly.

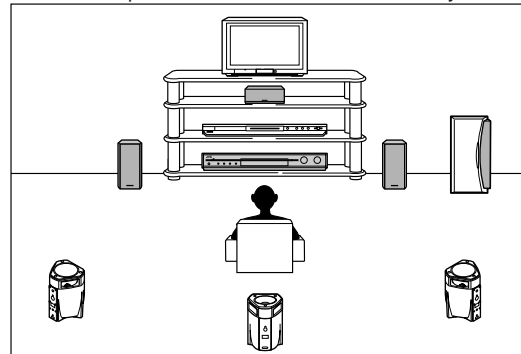

2 Press and hold SMART SURROUND SETUP until “SETTING UP” flashes.

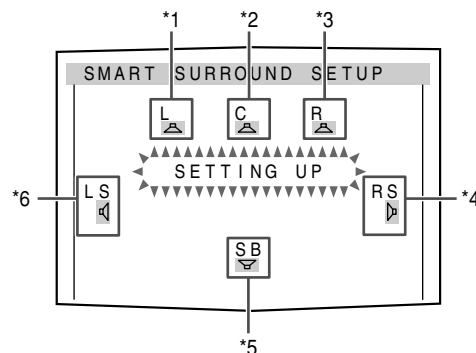

- *1 L: Left front speaker
- *2 C: Center speaker
- *3 R: Right front speaker
- *4 RS: Right surround speaker
- *5 SB: Surround back speaker
- *6 LS: Left surround speaker

3 When “CLAP YOUR HANDS.” appears, clap your hands over your head once while the indications still remain.

- On the display, “SETTING UP” stops flashing.

The receiver starts detecting the level of the sound coming through each speaker (except the subwoofer).

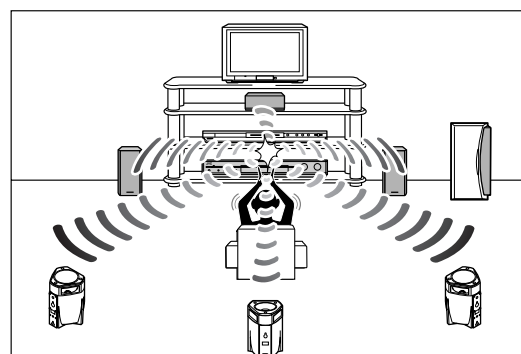

When your clapping sound is detected successfully,

- On the TV screen, "SUCCESSFUL," "RESULT," and the setting values appear. The setting values are shown for about 12 seconds.

Ex.:

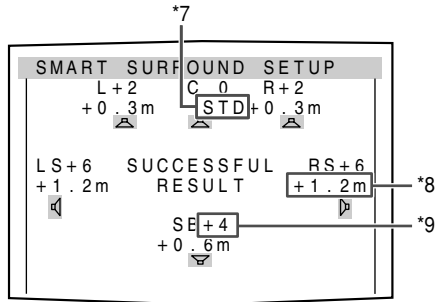

- On the display, "SUCCESSFUL" appears, then the setting values are shown as follows for about 12 seconds:

Ex.:

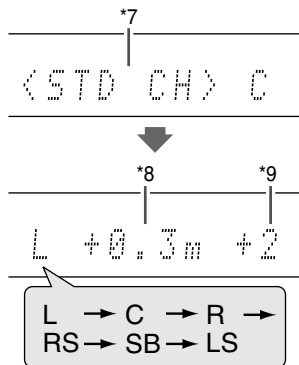

- *7 Standard channel (the closest speaker). This speaker position now works as the reference position ("0m/ft") and other speakers' distance is shown by the difference with this reference speaker position.
- *8 Difference of each speaker position in distance (in meters or feet).
- *9 Each speaker's output level (-6 to +6).

When finishing to show the setting values,

On the TV screen, "COMPLETED" appears, then "TEST TONE" and "END" appear. On the display, "TEST? END?" appears.

- To adjust the speakers' output levels manually, press TEST TONE (see page 29).
- To disappear the on-screen display, press SET or any button except TEST TONE.
- The receiver returns to normal operation mode automatically if no operations are done for about 10 seconds.

Ex.:

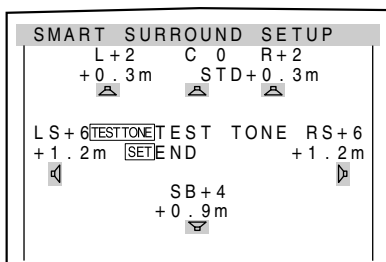

When your clapping sound is not detected correctly,

"SETTING UP" appears again after one of the following messages. In this case, repeat step 3.

- SILENT:**
 - The receiver detects sound from only the left and right front speakers.
 - The receiver detects no sound from the front speakers and detects sound from at least one of other speakers.
- SILENT-ALL:** The receiver cannot detect any sound from any speaker for about 10 seconds.
- AGAIN:**
 - The receiver cannot detect sound from the left or right front speaker.
 - The receiver fails to calculate the speakers' output level and difference of each speaker's position in distance.

In the following cases, set the speakers manually.

When "SILENT" appears twice in succession.

The setting is partially made. (The distance of the speakers from which sound has not been detected is set to "+9.0m (+30ft).")

The receiver exits from Smart Surround Setup.

When "MANUAL" appears.

The receiver fails to detect the sound three times. The receiver exits from Smart Surround Setup.

To cancel Smart Surround Setup, press SMART SURROUND SETUP while "SETTING UP" flashes.

- No other operations can be accepted after "SETTING UP" stops flashing. Complete the Smart Surround Setup.

To check the current setting made by Smart Surround Setup,

press SMART SURROUND SETUP while the receiver is in normal operation mode.

The setting values appear. On the display, the setting values are shown one after another.

- The current setting is not indicated but "MANUAL" appears if you change the following settings after using Smart Surround Setup:
 - If you change speaker distance manually.
 - If you change one of the speaker sizes either from "NO" to "SMALL" or "LARGE," or from "SMALL" or "LARGE" to "NO."
 To check the current setting, see each setting item of the speaker distance (see page 22) and the speaker output level (see page 29).
- If you have not used Smart Surround Setup, "NO S.S.S." appears.

NOTES

- The speaker distance and output level manually set will be applied instead of those set by using Smart Surround Setup in the following cases:
 - When you change one of the speaker distance (see page 22).
 - When you change one of the speaker size either from "NO" to "SMALL" or "LARGE," or from "SMALL" or "LARGE" to "NO" (see page 21).
- When you want to adjust the speaker distance and output level manually, see pages 22 and 29.
- When the headphone is in use or "DVD MULTI" is selected as the source, the receiver returns to normal operation mode without showing "TEST TONE."
- Do not clap your hands so hard that it may hurt your hands.

Basic setting items

You can adjust the following items. See pages in parentheses for details.

- You cannot select the items which is not available with the current setting.
- The name of the item shown below is the on-screen display indication and the name in parentheses is the display indication.

Items and to do	
SUBWOOFER (SUBWOOFER) Register your subwoofer. (21)	DUAL MONO (DUAL MONO) Select the Dual Mono sound channel. (23)
FRONT SPK (FRONT SPK) Register your front speaker size. (21)	SUBWFR OUT (SUBWFR OUT) Select sounds emitted from the subwoofer. (23)
CENTER SPK (CENTER SPK) Register your center speaker size. (21)	CROSSOVER (CROSSOVER) Select the cutoff frequency to the subwoofer. (23)
SURR. SPK (SURRND SPK) Register your surround speaker size. (21)	LFE ATT (LFE ATT) Attenuate the bass (LFE) sounds. (23)
SURR. BACK SPK (S BACK SPK) Register your surround back speaker size. (21)	MIDNIGHT (MIDNIGHT) Reproduce a powerful sound at night. (24)
DISTANCE UNIT (DIST UNIT) Select the measuring unit for the speaker distance. (22)	DIGITAL IN 1 (DIGITAL IN1) Select the component connected to the digital coaxial terminal—1(DVR/DVD). (24)
FL SPK DISTANCE (FRNT L DIST)* Register the distance from the left front speaker to your listening point. (22)	DIGITAL IN 2 (DIGITAL IN2) Select the component connected to the digital optical terminal—2(VIDEO). (24)
FR SPK DISTANCE (FRNT R DIST)* Register the distance from the right front speaker to your listening point. (22)	DIGITAL IN 3 (DIGITAL IN3) Select the component connected to the digital optical terminal—3(TV). (24)
C SPK DISTANCE (CENTER DIST)* Register the distance from the center speaker to your listening point. (22)	DVD VIDEO (DVD VIDEO) Select the type of video terminal used for the DVD recorder or DVD player. (25)
LS SPK DISTANCE (SURR L DIST)* Register the distance from the left surround speaker to your listening point. (22)	VCR VIDEO (VCR VIDEO) Select the type of video terminal used for the VCR. (25)
RS SPK DISTANCE (SURR R DIST)* Register the distance from the right surround speaker to your listening point. (22)	SUPERIMPOSE (SUPERIMPOSE) Select to superimpose the menus on the TV screen. (25)
SB SPK DISTANCE (S BACK DIST)* Register the distance from the surround back speaker to your listening point. (22)	DOWN MIX (DOWN MIX) Select to convert S-video signals into composite video signals. (25)
EX/ES/PLIIX (EX/ES/PLIIX) Select the EX/ES/PLIIX reproduction mode. (22)	Y/C SEPARATE (Y/C SEP.) Select to convert composite video signals into S-video signals. (25)

* If you have used Smart Surround Setup on pages 16 and 17, these settings are not required.

Operation through on-screen display menus

You can make adjustments to the basic settings easily by using the on-screen display menus.

Menu operation buttons

On the front panel:



Button / JOG	To do
SETTING button	show setting item previously selected.
SET button	move to the selected menu or return to the previous SETTING MENU.
MULTI JOG	<ul style="list-style-type: none"> • select a menu or an item. • change a setting.

From the remote control:

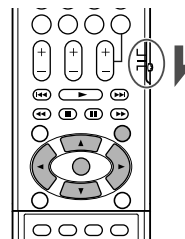

When operating the receiver using the remote control, set the mode selector to "AUDIO/TV/VCR/DBS."

Button	To do
MENU button	show "TOP MENU."
▲ / ▼ buttons	select a menu or an item.
SET button	move to the selected menu or return to the previous SETTING MENU.
◀ / ▶ buttons	change a setting.

Setup menu configuration

- Items on the menus shown below are all set to the initial values when shipping from the factory.
- Some of the menus or some items on the menu cannot be shown or cannot be adjusted depending on the current settings and the connections. (For details, see the respective explanations in this section.)

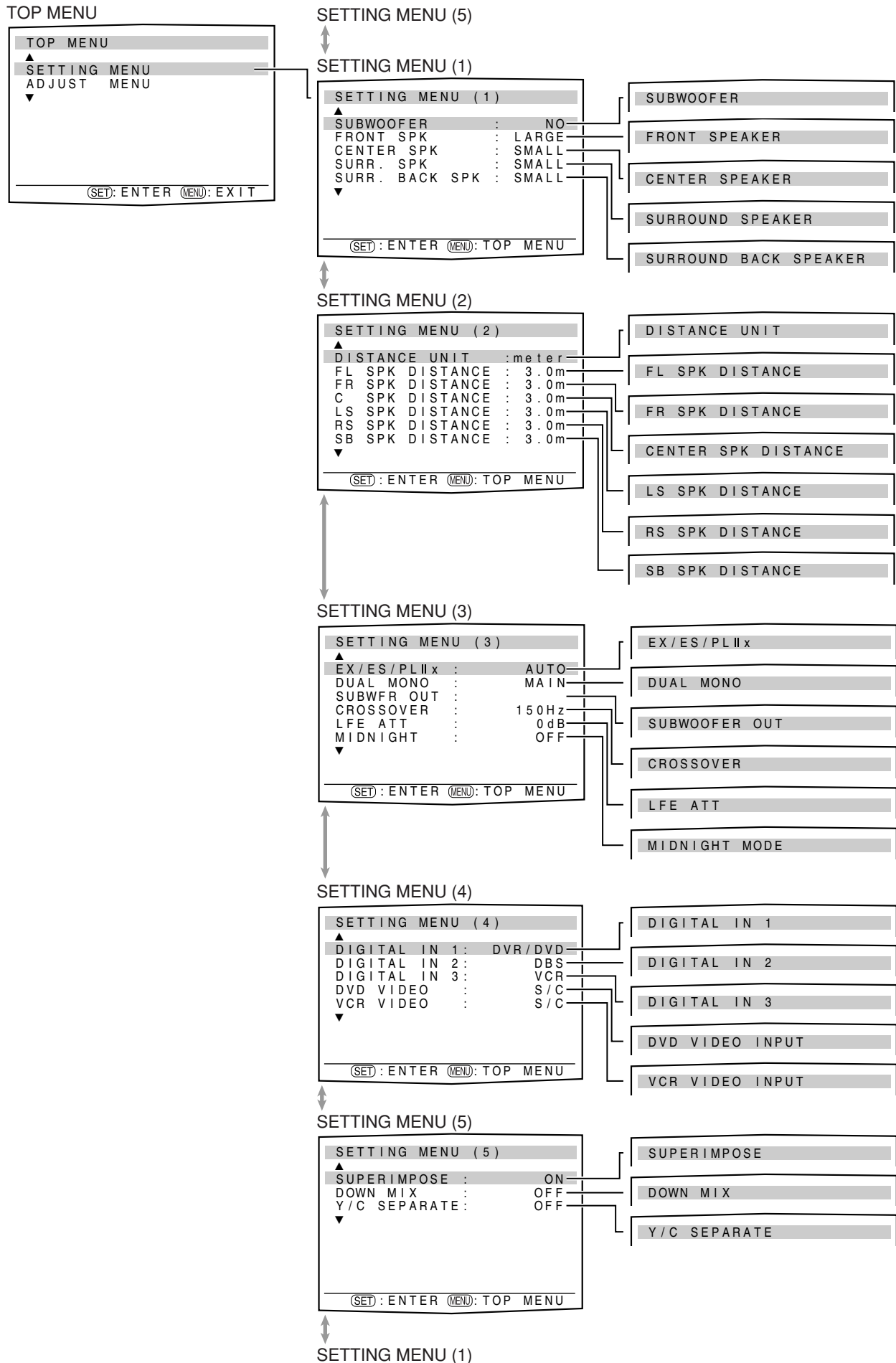

Menu operating procedure

When operating, the on-screen display appears on the TV screen regardless of the SUPERIMPOSE setting (see page 25).

Before you start, remember...

There is a time limit in doing the following steps. If the setting is canceled before you finish, start from step **1** again.

In this section, the operation of the remote control is used for explaining.

Ex.: When setting DIGITAL IN 1 terminal.

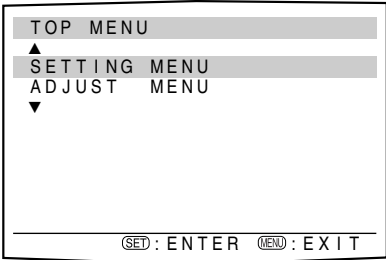
Operations	On the TV screen	On the display
<p>1 To show “TOP MENU,” press MENU.</p>	 <p>“TOP MENU” appears.</p>	<div style="border: 1px solid black; padding: 5px; width: fit-content; margin: 0 auto;">SETTING</div> <p>“SETTING” appears.</p>

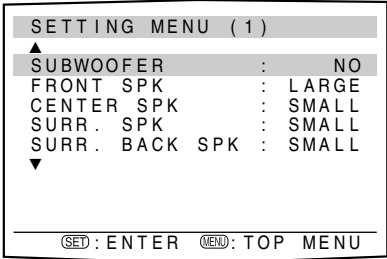
<p>2 To select “SETTING MENU,” press SET.</p>	 <p>The setting item previously selected appears.</p>	<div style="border: 1px solid black; padding: 5px; width: fit-content; margin: 0 auto;">SUBWOOFER</div> <p>The submenu previously selected appears.</p>
--	--	---

3 To select the desired submenu, press ▲ or ▼ repeatedly.

There are five screens from “SETTING MENU (1)” to “SETTING MENU (5).” To change the screen, simply pressing ▲ or ▼ repeatedly. You can go to the next/previous screen.

- On the front panel, turn MULTI JOG.

Button indications on the screen

The buttons for operating the menu are shown on the TV screen. You can operate the menu with these buttons.

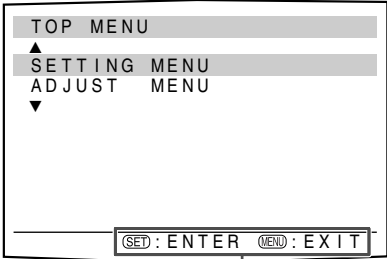
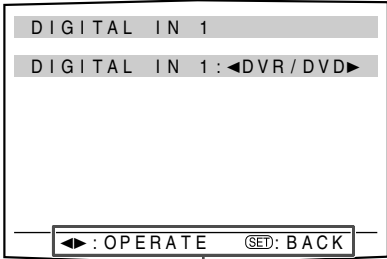
 <p>Usable buttons and their functions</p>	 <p>Usable buttons and their functions</p>
---	--

4 Press SET.

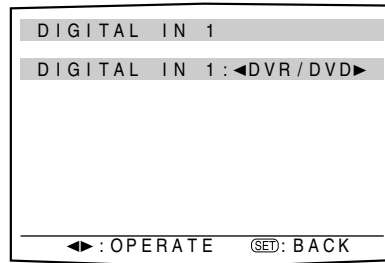

D1 DVR/DVD

The current setting of the selected item appears.

The selected submenu appears.

5 To select the appropriate setting, press < or > repeatedly, then press SET.

The on-screen display returns to the previous SETTING MENU. In this example, "SETTING MENU (4)" appears on the TV screen and "DIGITAL IN1" appears on the display.

- On the front panel, turn MULTI JOG, then press SET.

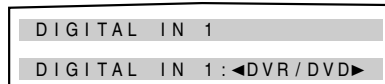

D1 DVR/DVD

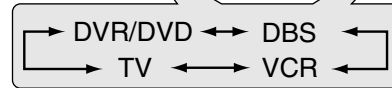

6 Repeat steps 2 to 5 to set other items if necessary.

NOTES

- To return to "TOP MENU," press MENU on the remote control.
- To exit from menu operations, press MENU on the remote control when "TOP MENU" appears. On the front panel, press SETTING when a menu except "TOP MENU" appears.
- The setting item previously selected can be shown on the TV screen by pressing SETTING on the front panel when the receiver is in normal operation mode.

Setting the items

When performing the basic settings viewing the indications on the display, the indications are slightly different from what is shown on the on-screen display.

This is because of the limited number of characters shown on the display.

Ex.: • "SUBWOOFER: YES" is shown as "SUBWFR: YES" on the display.

- "MIDNIGHT MODE: OFF" is shown as "NIGHT: OFF" on the display.

Setting the speakers

■ Setting subwoofer information—SUBWOOFER

Each time the receiver turns on, the receiver detects the subwoofer connection and automatically changes the setting of the subwoofer.

When you want to change the setting manually, select either one below.

SUBWOOFER: YES

Select when you have connected a subwoofer.

The subwoofer indicator (**S.WFR**) lights up on the display. You can adjust the subwoofer output level (see page 29).

SUBWOOFER: NO

Select when you have disconnected a subwoofer. Selecting this changes the front speaker size to "LARGE" (see right column).

NOTE

You need to change the setting each time you turn on the receiver if you want to change the subwoofer information set automatically.

■ Setting the speaker size—FRONT SPEAKER, CENTER SPEAKER, SURROUND SPEAKER, SURROUND BACK SPEAKER

Register the sizes of all the connected speakers.

LARGE	Select when the cone speaker size is larger than 12 cm.
SMALL	Select when the cone speaker size is smaller than 12 cm.
NO	Select when you have disconnected a speaker. (Not selectable for the front speakers.)

Initial setting: SMALL for all speakers*

* When "SUBWOOFER" is set to "SUBWOOFER: NO," the front speaker size is fixed to "LARGE" (and you cannot select "SMALL").

NOTES

- If you have selected "SMALL" for the front speaker size, you cannot select "LARGE" for other speakers.
- When "SURROUND SPEAKER" is set to "SURROUND SPK: SMALL," you cannot select "LARGE" for the surround back speaker.
- When "SURROUND SPEAKER" is set to "SURROUND SPK: NO," the surround back speaker is fixed to "NO."
- If you change one of the speaker sizes either from "NO" to "SMALL" or "LARGE," or from "SMALL" or "LARGE" to "NO," the distance manually set will be applied instead of those set by using Smart Surround Setup.

■ Setting the speaker distance

The distance from your listening point to the speakers is one of the important elements to obtain the best possible sound effect from the Surround/DSP modes.

By referring to the speaker distance, the receiver automatically sets the delay time of the sound through each speaker so that sounds through all the speakers can reach you at the same time.

- If you have used Smart Surround Setup on pages 16 and 17, this setting is not required.

■ Measuring unit—DISTANCE UNIT

Select which measuring unit you use.

DISTANCE UNIT: meter Select to set the distance in meters.

DISTANCE UNIT: feet Select to set the distance in feet.

Initial setting: DISTANCE UNIT: meter

■ Speaker distance—

**FL SPK DISTANCE (for the left front speaker),
FR SPK DISTANCE (for the right front speaker),
CENTER SPK DISTANCE (for the center speaker),
LS SPK DISTANCE (for the left surround speaker),
RS SPK DISTANCE (for the right surround speaker),
SB SPK DISTANCE (for the surround back speaker)**

Adjustable range: 0.3 m to 9.0 m in 0.3 m intervals
(1 ft to 30 ft in 1 ft intervals)

Initial setting: 3.0 m (10 ft) for all speakers

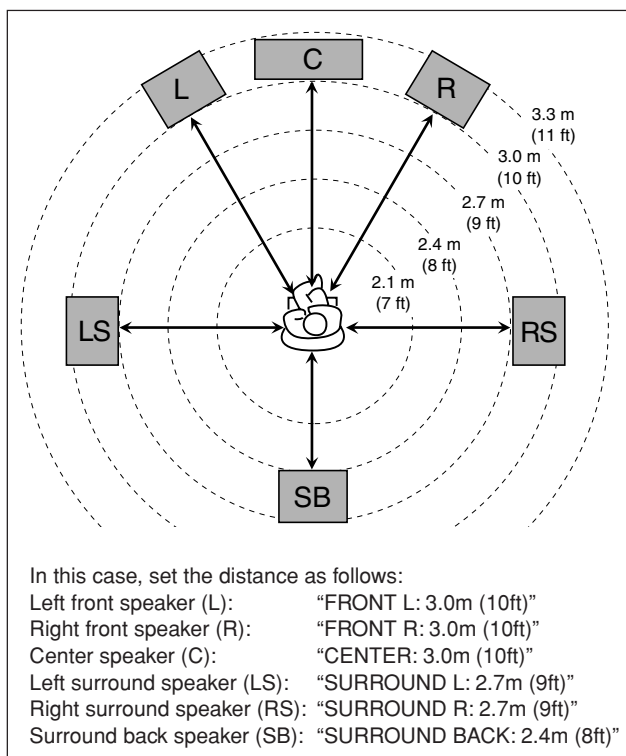

NOTES

- You cannot set the speaker distance for the speakers you have set to "NO."
- If you change one of these settings manually, the distance manually set will be applied instead of those set by using Smart Surround Setup.

Activating the EX/ES/PLIIX setting —EX/ES/PLIIX

Depending on this setting, available Surround modes for digital multi-channel software vary—EX/ES/PLIIX (6.1-channel) reproduction or 5.1-channel reproduction. Select an appropriate setting for your enjoyment.

- For details about relation between EX/ES/PLIIX setting and available Surround mode, see page 38.
- To activate the Surround mode, see page 39.

EX/ES/PLIIX: AUTO

According to the incoming signal, an appropriate Surround mode is applied.

- For Dolby Digital Surround EX and DTS-ES software, 6.1-channel reproduction is applied*.
- For other multi-channel (more than 4 channel) encoded software, 5.1-channel reproduction is applied.

EX/ES/PLIIX: ON

Select to apply 6.1-channel reproduction to both 5.1-channel and 6.1-channel encoded software.

EX/ES/PLIIX: PLIIX MOVIE

Select to apply "PLIIX MOVIE" (6.1-channel) reproduction to both 5.1-channel and 6.1-channel encoded software.

EX/ES/PLIIX: PLIIX MUSIC

Select to apply "PLIIX MUSIC" (6.1-channel) reproduction to both 5.1-channel and 6.1-channel encoded software.

EX/ES/PLIIX: OFF

Select to cancel the EX/ES/PLIIX (6.1-channel) reproduction.

Initial setting: EX/ES/PLIIX: AUTO

- * For some Dolby Digital Surround EX software, Dolby Digital 5.1-channel reproduction ("DOLBY D") may be applied even though you have selected "EX/ES/PLIIX: AUTO." In this case, select "EX/ES/PLIIX: ON" to apply "DOLBY D EX."

From the remote control

You can also make adjustments the following way from the remote control.

Set the mode selector to "AUDIO/TV/VCR/DBS."

Press EX/ES repeatedly to select an appropriate setting for your enjoyment.

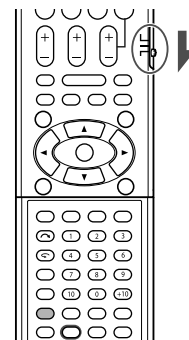

NOTES

- This function is not available in the following cases:
 - When "SURROUND SPEAKER" is set to "SURROUND SPK: NO" (see page 21).
 - When "DVD MULTI" is selected as the source.
- When "SURROUND BACK SPEAKER" is set to "SURR. BACK SPK: NO" (see page 21), the Virtual Surround Back (see page 38) is applied to EX/ES/PLIIX (6.1-channel) reproduction.

Selecting the main or sub channel —DUAL MONO

You can select the playback sound (channel) you want while playing digital software recorded (or broadcasted) in Dual Mono mode (see page 36), which includes two monaural channels separately.

DUAL MONO: MAIN

Select to play back the main channel (Ch 1).*
Signal indicator “L” lights up while playing back this channel.

DUAL MONO: SUB

Select to play back the sub-channel (Ch 2).*
Signal indicator “R” lights up while playing back this channel.

DUAL MONO: ALL

Select to play back both the main and sub-channels (Ch 1/Ch 2).*
Signal indicators “L” and “R” light up while playing back these channels.

Initial setting: DUAL MONO: MAIN

* Dual Mono signals can be heard from the following speakers—L (left front speaker), R (right front speaker), and C (center speaker), with respect to the current Surround setting:

Dual Mono setting	Without Surround		With Surround Activated				
			Center speaker setting				
			SMALL/LARGE			NO	
L	R	L	C	R	L	R	
MAIN	Ch 1	Ch 1	—	Ch 1	—	Ch 1	Ch 1
SUB	Ch 2	Ch 2	—	Ch 2	—	Ch 2	Ch 2
ALL	Ch 1	Ch 2	—	Ch 1+Ch 2	—	Ch 1+Ch 2	Ch 1+Ch 2

NOTE

The Dual Mono format is not identical with bilingual broadcasting for TV programs. So this setting does not take effect while watching such bilingual programs.

Setting bass sound

■ Setting subwoofer output—SUBWOOFER OUT

You can select the type of the signal which can be transmitted through the subwoofer. In other words, you can determine whether or not the bass elements of the front speaker channels are transmitted through the subwoofer regardless of the front speaker size setting (either “SMALL” or “LARGE”).

SUBWFR OUT: LFE

Select to emit only the LFE signals (while playing Dolby Digital and DTS software) or the bass elements of the “SMALL” front speakers (while playing any source other than above).

SUBWFR OUT: LFE+MAIN

Select to always emit the bass elements of the front speaker channels (MAIN). While playing Dolby Digital and DTS software, the bass elements and the LFE signals are both emitted.

Initial setting: SUBWFR OUT: LFE

NOTE

When “SUBWOOFER” is set to “SUBWOOFER: NO” (see page 21), this function is not available.

■ Setting the crossover frequency—CROSSOVER

Small speakers cannot reproduce the bass sounds efficiently. If you use a small speaker in any position, this receiver automatically reallocates the bass sound elements assigned to the small speaker to the large speakers.

To use this function properly, set this crossover frequency level according to the size of the small speaker connected.

- If you have selected “LARGE” for all speakers (see page 21), this function will not take effect (“CROSSOVER: OFF” appears).

CROSSOVER: 80Hz Select when the cone speaker unit built in the speaker is about 12 cm.

CROSSOVER: 100Hz Select when the cone speaker unit built in the speaker is about 10 cm.

CROSSOVER: 120Hz Select when the cone speaker unit built in the speaker is about 8 cm.

CROSSOVER: 150Hz Select when the cone speaker unit built in the speaker is about 6 cm.

CROSSOVER: 200Hz Select when the cone speaker unit built in the speaker is less than 5 cm.

Initial setting: CROSSOVER: 150Hz

NOTE

Crossover frequency is not valid for the HEADPHONE and 3D HEADPHONE modes.

■ Setting the low frequency effect attenuator —LFE ATT

If the bass sound is distorted while playing back software encoded with **Dolby Digital** or **DTS**, set the LFE level to eliminate distortion.

- This function takes effect only when the LFE signals come in.

LFE ATT: 0dB Normally select this.

LFE ATT: -10dB Select when the bass sound is distorted.

Initial setting: LFE ATT: 0dB

Using the Midnight mode —MIDNIGHT MODE

You can enjoy a powerful sound at night using the Midnight mode.

- Once you have made an adjustment, it is memorized for each source.

MIDNIGHT MODE: OFF

Select when you want to enjoy surround with its full dynamic range. (No effect applied.)

MIDNIGHT MODE: 1

Select when you want to reduce the dynamic range a little.

MIDNIGHT MODE: 2

Select when you want to apply the compression effect fully (useful at night).

Initial setting: MIDNIGHT MODE: OFF

From the remote control

You can also make adjustments the following way from the remote control.

Set the mode selector to "AUDIO/TV/VCR/DBS."

Press **SOUND**, then press **MIDNIGHT** repeatedly to select either one of the above.

NOTE

After pressing SOUND, the numeric buttons work for sound adjustments. To use the numeric buttons to operate your target source, press the corresponding source selecting button before operation; otherwise, the remote control may not work as you intend.

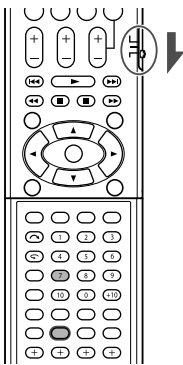

Setting the digital input (DIGITAL IN) terminals—DIGITAL IN 1/2/3

When you use the digital input terminals, register what components are connected to which terminals—DIGITAL IN 1/2/3 (see page 11) so that the correct source name will appear when you select the digital source.

Select one of the following components for each terminal:

DVR/DVD For the DVD player (or DVD recorder).

DBS For the DBS tuner.

VCR For the VCR.

TV For the TV.

Initial setting: DVR/DVD (for "DIGITAL IN 1")
DBS (for "DIGITAL IN 2")
VCR (for "DIGITAL IN 3")

NOTES

- You cannot assign the same component for different terminals. The priority order for assignment is as follows: "DIGITAL IN 1" > "DIGITAL IN 2" > "DIGITAL IN 3." "DIGITAL IN 1" can be set to any component.
Ex.: When "DIGITAL IN 1" is set to "TV,"
DIGITAL IN 1:
"DVR/DVD," "DBS," and "VCR" are selectable for "DIGITAL IN 2."
And when "DIGITAL IN 2" is set to "DVR/DVD,"
DIGITAL IN 1:
DIGITAL IN 2:
"DBS" and "VCR" are selectable for "DIGITAL IN 3."
- Setting "DIGITAL IN 1" affects "DIGITAL IN 2" and "DIGITAL IN 3" settings. When you have changed "DIGITAL IN 1," confirm the components assigned to "DIGITAL IN 2" and "DIGITAL IN 3."

Selecting the component video input mode—DVD VIDEO INPUT/VCR VIDEO INPUT

When you use the component video inputs for connecting the DVD recorder (or DVD player) or VCR, register the type of video input jacks.

If you have not selected appropriate video input jacks, you cannot view the playback picture on the TV or the AV COMPU LINK remote control system cannot operate properly (see page 40).

For the DVD recorder or DVD player (DVD VIDEO):

DVD VIDEO: S/C

Select when connecting the DVD recorder (or DVD player) to the composite video or S-video input jacks.

DVD VIDEO: COMPONENT

Select when connecting the DVD recorder (or DVD player) to the component video input jacks.

Initial setting: DVD VIDEO: S/C

For the VCR (VCR VIDEO):

VCR VIDEO: S/C

Select when connecting the VCR to the composite video or S-video input jacks.

VCR VIDEO: COMPONENT

Select when connecting the VCR to the component video input jacks.

Initial setting: VCR VIDEO: S/C

Superimposing the menus —SUPERIMPOSE

You can select whether or not to superimpose the on-screen display on the TV screen.

SUPERIMPOSE: ON

Select to superimpose the on-screen display on the TV screen.

SUPERIMPOSE: OFF

Select to cancel superimposition. The on-screen display will be shown on the blue background screen.

Initial setting: SUPERIMPOSE: ON

NOTES

- Some on-screen displays appear on the TV screen regardless of this setting.
- The on-screen display does not appear on the TV screen when connecting the TV through the COMPONENT MONITOR OUT jacks (see page 10).

Converting S-video signals into composite video signals—DOWN MIX

You can select whether or not to convert S-video signals into composite video signals.

DOWN MIX: ON Select to convert S-video signals into composite video signals.

DOWN MIX: OFF Select not to use this function.

Initial setting: DOWN MIX: OFF

NOTES

- This function is available when satisfying all the following requirements:
 - When a video component is connected to this receiver through at least one of the S-video input terminals.
 - When a video component or the TV is connected to this receiver through at least one of the composite video output jacks.
 - Either the DVD VIDEO INPUT or VCR VIDEO INPUT is set to “S/C” (see left column).
- When using this function, set the input mode of the TV correctly. (Refer also to the manual supplied with the TV.)

Converting composite video signals into S-video signals—Y/C SEPARATE

You can select whether or not to convert composite video signals come from a video component into S-video signals.

Y/C SEPARATE: ON Select to convert composite video signals into S-video signals.

Y/C SEPARATE: OFF Select not to use this function.

Initial setting: Y/C SEPARATE: OFF

NOTES

- This function is available when satisfying all the following requirements:
 - When a video component is connected to this receiver through at least one of the composite video input jacks.
 - When a video component or the TV is connected to this receiver through at least one of the S-video output terminals.
 - Either the DVD VIDEO INPUT or VCR VIDEO INPUT is set to “S/C” (see left column).
- When using this function, set the input mode of the TV correctly. (Refer also to the manual supplied with the TV.)

Sound adjustments

You can make sound adjustment to your preference after completing basic setting.

Basic adjustment items

You can adjust the following items. See pages in parentheses for details.

- You cannot select the items which is not available with the current setting.
- The name of the item shown below is the on-screen display indication and the name in parentheses is the display indication.

Items and to do	
SUBWOOFER LEVEL (SUBWFR LVL) Adjust the subwoofer output level. (29)	BASS BOOST (BASS BOOST) Boost the bass level. (30)
FRONT L LEVEL (FRONT L LVL) Adjust the left front speaker output level. (29)	SUBWFR PHASE (SBWFR PHASE) Select the subwoofer sound phase. (30)
FRONT R LEVEL (FRONT R LVL) Adjust the right front speaker output level. (29)	INPUT ATT (INPUT ATT) Attenuate the input level of analog source. (30)
CENTER LEVEL (CENTER LVL) Adjust the center speaker output level. (29)	EFFECT (EFFECT) Adjust the effect level. (31)
SURR. L LEVEL (SURR L LVL) Adjust the left surround speaker output level. (29)	PANORAMA (PANORAMA) Add wraparound sound effect with side-wall image. (31)
SURR. R LEVEL (SURR R LVL) Adjust the right surround speaker output level. (29)	CENTER GAIN (CENTER GAIN) Adjust the sound localization of the center channel. (31)
SURR. BACK LEVEL (S BACK LVL) Adjust the surround back speaker output level. (29)	CENTER TONE (CENTER TONE) Make the center tone soft or sharp. (31)
DIGITAL EQ 63Hz (D EQ 63Hz)* DIGITAL EQ 250Hz (D EQ 250Hz)* DIGITAL EQ 1kHz (D EQ 1kHz)* DIGITAL EQ 4kHz (D EQ 4kHz)* DIGITAL EQ 16kHz (D EQ 16kHz)* Adjust the equalization pattern of each band. (30)	CNTR ALIGNMENT (CNTR ALIGN) Align the vertical localization of the center channel. (31)

* If you have used Smart Surround Setup on pages 16 and 17, these settings are not required.

Operation through on-screen display menus

You can make adjustments to the basic settings easily by using the on-screen display menus.

Menu operation buttons

On the front panel:

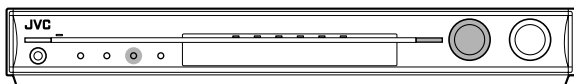

Button / JOG	To do
ADJUST button	show adjustment item previously selected.
SET button	move to the selected menu or return to the previous ADJUST MENU.
MULTI JOG	<ul style="list-style-type: none"> • select a menu or an item. • change a setting.

From the remote control:

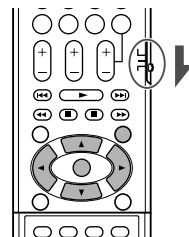

When operating the receiver using the remote control, set the mode selector to "AUDIO/TV/VCR/DBS."

Button	To do
MENU button	show "TOP MENU."
▲ / ▼ buttons	select a menu or an item.
SET button	move to the selected menu or return to the previous ADJUST MENU.
◀ / ▶ buttons	change a setting.

Setup menu configuration

- Items on the menus shown below are all set to the initial values when shipping from the factory.
- Some of the menus or some items on the menu cannot be shown or cannot be adjusted depending on the current settings and the connections. (For details, see the respective explanations in this section.)
- The "ADJUST MENU (3)" screen cannot be shown depending on the current settings and the connections.

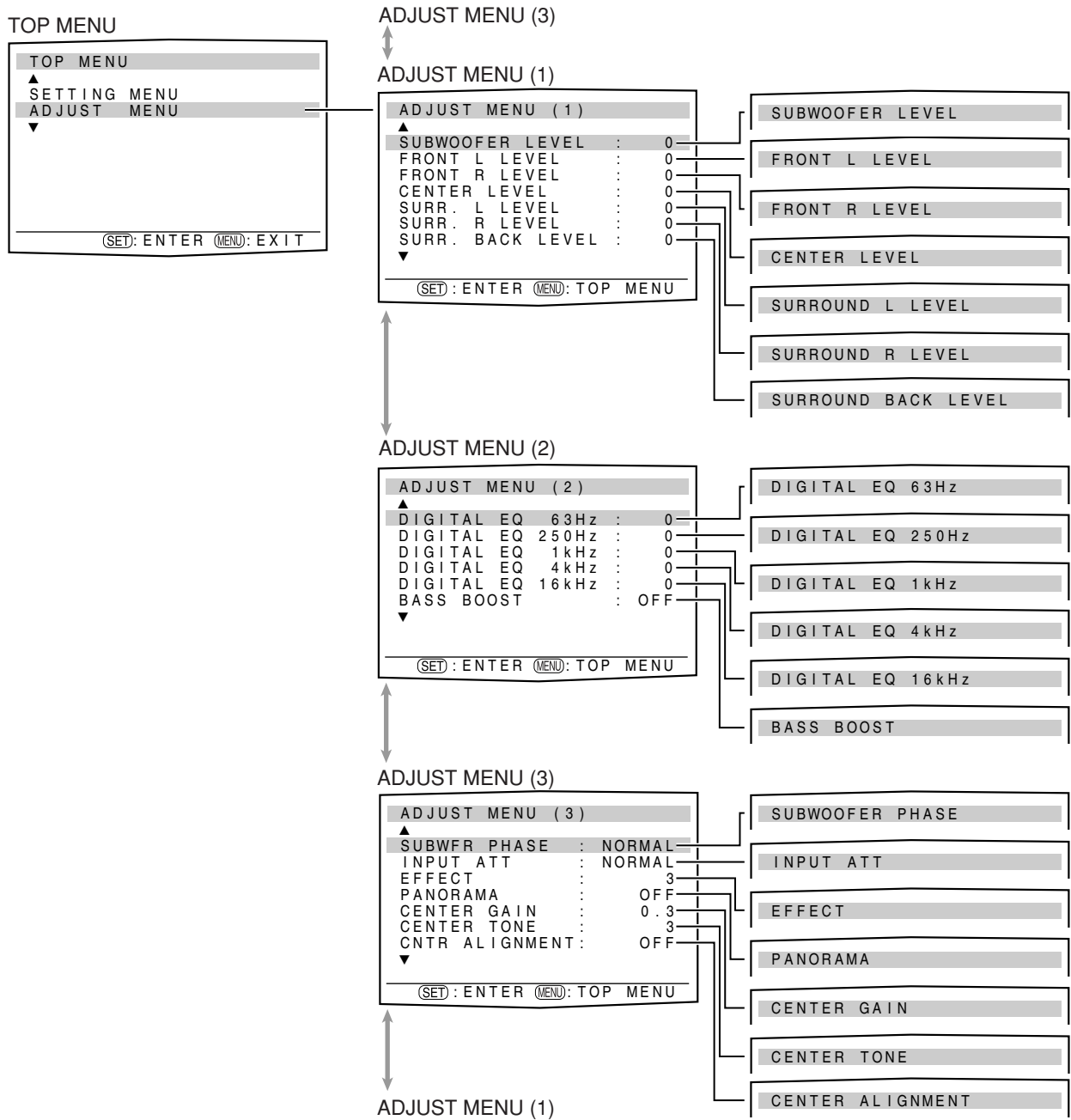

Menu operating procedure

When operating, the on-screen display appears on the TV screen regardless of the SUPERIMPOSE setting (see page 25).

Before you start, remember...

There is a time limit in doing the following steps. If the setting is canceled before you finish, start from step 1 again.

In this section, the operation of the remote control is used for explaining.

Ex.: When adjusting subwoofer output level.

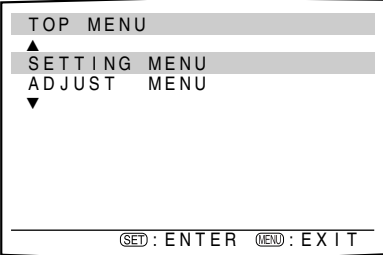
Operations	On the TV screen	On the display
<p>1 To show “TOP MENU,” press MENU. Then press ▲ or ▼ to select “ADJUST MENU.”</p> <ul style="list-style-type: none"> On the front panel, turn MULTI JOG. 	 <p>“TOP MENU” appears.</p>	<div style="border: 1px solid black; padding: 5px; display: inline-block;">SETTING</div> <p>“SETTING” appears.</p>

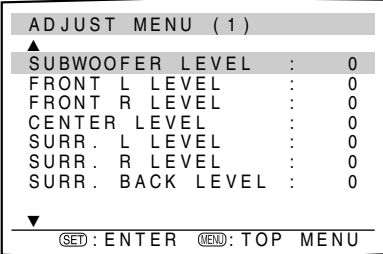
<p>2 To select “ADJUST MENU,” press SET.</p>	 <p>The adjustment item previously selected appears.</p>	<div style="border: 1px solid black; padding: 5px; display: inline-block;">SUBWFR LVL</div> <p>The submenu previously selected appears.</p>
---	---	---

3 To select the desired submenu, press ▲ or ▼ repeatedly.

There are three screens from “ADJUST MENU (1)” to “ADJUST MENU (3).” To change the screen, simply pressing ▲ or ▼ repeatedly. You can go to the next/previous screen.

- On the front panel, turn MULTI JOG.

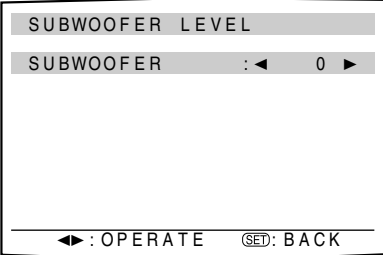
<p>4 Press SET.</p>	 <p>The selected submenu appears.</p>	<div style="border: 1px solid black; padding: 5px; display: inline-block;">SUBWFR 0</div> <p>The current setting of the selected item appears.</p>
----------------------------	---	--

5 To adjust the selected item, press ◀ or ▶ repeatedly, then press SET.

The on-screen display returns to the previous ADJUST MENU. In this example, “ADJUST MENU (1)” appears on the TV screen and “SUBWFR LVL” appears on the display.

- On the front panel, turn MULTI JOG, then press SET.

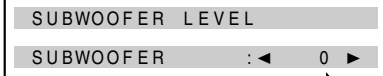
	<div style="border: 1px solid black; padding: 5px; display: inline-block;">SUBWFR 0</div>
<div style="border: 1px solid black; padding: 5px; display: inline-block; margin: 10px auto;"> -10 ◀-----▶ 0 ◀-----▶ +10 </div>	

6 Repeat steps 2 to 5 to set other items if necessary.

NOTES

- To return to "TOP MENU," press MENU on the remote control.
- To exit from menu operations, press MENU on the remote control when "TOP MENU" appears. On the front panel, press ADJUST when a menu except "TOP MENU" appears.
- The adjustment item previously selected can be shown on the TV screen by pressing ADJUST on the front panel when the receiver is in normal operation mode.

Button indications on the screen

The buttons for operating the menu are shown on the TV screen. You can operate the menu with these buttons.

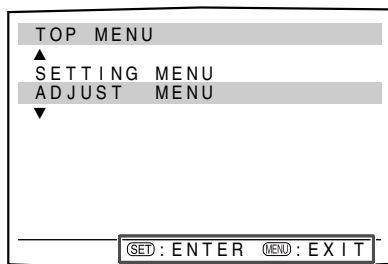

Usable buttons and their functions

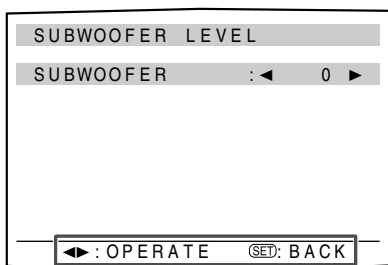

Usable buttons and their functions

Adjusting the items

When performing the basic settings viewing the indications on the display, the indications are slightly different from what is shown on the on-screen display.

This is because of the limited number of characters shown on the display.

- EX.: • "SUBWOOFER: +10" is shown as "SUBWFR +10" on the display.
- "BASS BOOST: ON" is shown as "B BOOST ON" on the display.

Adjusting speaker output level

- **SUBWOOFER LEVEL** (subwoofer output level),
- **FRONT L LEVEL** (left front speaker output level),
- **FRONT R LEVEL** (right front speaker output level),
- **CENTER LEVEL** (center speaker output level),
- **SURROUND L LEVEL** (left surround speaker output level),
- **SURROUND R LEVEL** (right surround speaker output level),
- **SURROUND BACK LEVEL** (surround back speaker output level)

You can adjust the speaker output levels.

Adjust all the speakers' output levels so that you can listen to the sounds from all the speakers at the same level.

- Once you have made an adjustment, it is memorized for each source.

Adjustable range: -10 (dB) to +10 (dB) (in 1 step intervals)

Initial setting: 0 (dB) for all speakers

NOTES

- If you have selected "NO" for a speaker (see page 21), the output level for the corresponding speaker is not adjustable.
- While using the headphones, you can adjust only the left and right front speakers' output level.

From the remote control:

You can also make adjustments the following way from the remote control.

Set the mode selector to "AUDIO/TV/VCR/DBS."



1 Press TEST TONE to check the speakers' output balance.

- On the TV screen, "TEST TONE" appears. The » indicator corresponding to the speaker appears while a test tone comes out of the speakers.

EX.:

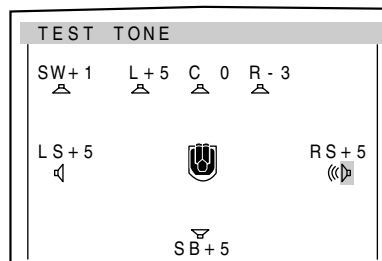

- On the display, "TEST L" starts flashing, and a test tone comes out of the speakers in the following order:

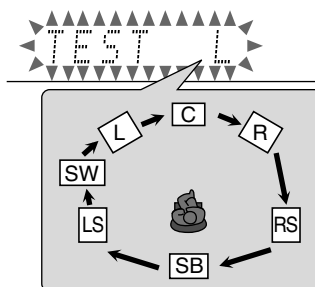

2 Adjust the speaker output levels.

To adjust the left front speaker level (L), press FRONT L +/-.

To adjust the right front speaker level (R), press FRONT R +/-.

To adjust the center speaker level (C), press CENTER +/-.

To adjust the left surround speaker level (LS), press SURR L +/-.

To adjust the right surround speaker level (RS), press SURR R +/-.

To adjust the surround back speaker level (SB), press S.BACK +/-.

To adjust the subwoofer level (SW), press SUBWFR +/-.

3 Press TEST TONE again to stop the test tone.

NOTES

- You can adjust the speaker output levels without the test tone.
- No test tone comes out of the speakers and no speaker indication appears on the TV screen corresponding to the speaker which is set to "NO" in the speaker setting (see page 21).
- No test tone is available when the headphone is in use or "DVD MULTI" is selected.

Adjusting the equalization patterns —DIGITAL EQ 63Hz/250Hz/1kHz/4kHz/16kHz

You can adjust equalization patterns in five frequency bands (center frequency: 63 Hz, 250 Hz, 1 kHz, 4 kHz, 16 kHz) for the front speakers.

- Once you have made an adjustment, it is memorized for each source.

Adjustable range: -8 (dB) to +8 (dB) (in 2 dB intervals)

Initial setting: 0 (dB) for all bands

- When adjustment is made, the EQ indicator lights up on the display.

If no adjustment is required, set all the frequency bands to "0 (dB)."

- The EQ indicator goes off from the display.

From the remote control:

You can also make adjustments the following way from the remote control.

Before you start, remember...

There is a time limit in doing the following steps. If the setting is canceled before you finish, start from step **2** again.

Set the mode selector to "AUDIO/TV/VCR/DBS."

- 1 Press SOUND.**
- 2 Press EQ FREQ repeatedly to select the band you want to adjust.**
- 3 Press EQ LEVEL \oplus/\ominus to adjust the equalization pattern of the selected band.**
- 4 Repeat steps 2 and 3 to adjust other bands.**

NOTE

After pressing SOUND, the numeric buttons work for sound adjustments. To use the numeric buttons to operate your target source, press the corresponding source selecting button before operation; otherwise, the remote control may not work as you intend.

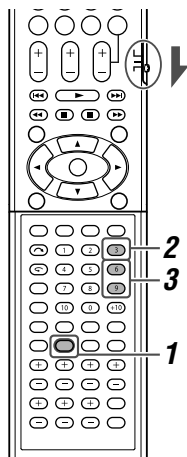

Adjusting the bass sounds

■ Reinforcing the bass—BASS BOOST

You can boost the bass level—Bass Boost.

- Once you have made an adjustment, it is memorized for each source.

BASS BOOST: ON Select to boost the bass level.
The BASS indicator lights up on the display.

BASS BOOST: OFF Select to deactivate the Bass Boost.

Initial setting: BASS BOOST: OFF

NOTE

This function affects only the sound coming out through the front speakers.

From the remote control:

You can also make adjustments the following way from the remote control.

Set the mode selector to "AUDIO/TV/VCR/DBS."

Press SOUND, then press BASS BOOST repeatedly.

- Each time you press BASS BOOST, the Bass Boost turns on and off alternately.

NOTE

After pressing SOUND, the numeric buttons work for sound adjustments. To use the numeric buttons to operate your target source, press the corresponding source selecting button before operation; otherwise, the remote control may not work as you intend.

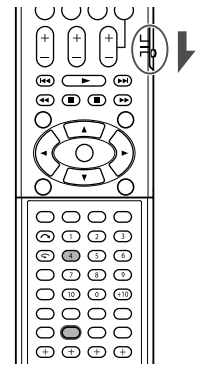

■ Selecting the subwoofer sound phase—SUBWOOFER PHASE

You can change the subwoofer sound phase to your preference.

- Once you have made an adjustment, it is memorized for each source.

PHASE: NORMAL Normally select this.

PHASE: REVERSE Select this when you feel the bass sound is better with this mode rather than with "PHASE: NORMAL."

Initial setting: PHASE: NORMAL

NOTE

This function takes effect only when "SUBWOOFER" is set to "SUBWOOFER: YES" (see page 21).

■ Attenuating the input signal—INPUT ATT

When the input level of **analog source** is too high, the sound will be distorted. If this happens, you need to attenuate the input signal level to prevent the sound distortion.

- Once you have made an adjustment, it is memorized for each source.

INPUT ATT: ON Select to attenuate the input signal level.
The ATT indicator lights up on the display.

INPUT ATT: NORMAL Select to deactivate attenuation.

Initial setting: INPUT ATT: NORMAL

Adjusting the sound parameters for the Surround/DSP modes

You can adjust the Surround/DSP sound parameters to your preference.

- For details about the Surround/DSP modes, see pages 34 to 39.

■ Adjusting the effect level for DSP modes —EFFECT

This setting is available only when one of the DSP modes (except ALL CH ST) is in use. To activate DSP mode, see page 39.

- Once you have made an adjustment, it is memorized for each DSP mode.

Adjustable range: 1 to 5 (in 1 step intervals)

Initial setting: EFFECT: 3

As the number increases, the effect becomes stronger.

Normally, select "3."

From the remote control:

You can also make adjustments the following way from the remote control.

Set the mode selector to "AUDIO/TV/VCR/DBS."

Press **SOUND**, then press **EFFECT** repeatedly.

NOTE

After pressing **SOUND**, the numeric buttons work for sound adjustments. To use the numeric buttons to operate your target source, press the corresponding source selecting button before operation; otherwise, the remote control may not work as you intend.

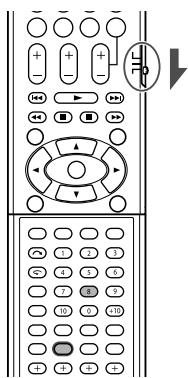

■ Adjusting the panorama control for Pro Logic II Music—PANORAMA

This setting is available only when Pro Logic II Music is in use. To activate Pro Logic II Music, see page 39.

- Once you have made an adjustment, it is memorized until you change the setting.

PANORAMA: ON Select to add "wraparound" sound effect with side-wall image.

PANORAMA: OFF Select to listen to originally recorded sound.

Initial setting: PANORAMA: OFF

■ Adjusting the sound localization of the center channel—CENTER GAIN

This setting is available only when Neo:6 Music is in use.

- If you have set "CENTER SPEAKER" to "CENTER SPK: NO" (see page 21), the center gain is not adjustable.
- Once you have made an adjustment, it is memorized until you change the setting.

Adjustable range: 0 to 1.0 (in 0.1 step intervals)

Initial setting: CENTER GAIN: 0.3

As the number increases, the center channel will be localized clearly.

Normally, select "0.3."

■ Making the center tone soft or sharp —CENTER TONE

This setting is available when one of the Surround/DSP modes is in use. To activate Surround/DSP mode, see page 39.

- This setting is common to all Surround modes, and is memorized separately for DSP modes.
- You cannot adjust the center tone in the following cases:
 - When "CENTER SPEAKER" is set to "CENTER SPK: NO" (see page 21).
 - When Dual Mono software is played back.
 - While listening with the headphones.

Adjustable range: 1 to 5 (in 1 step intervals)

Initial setting: CENTER TONE: 3

As the number increases, the dialogue becomes stronger.

Normally, select "3."

- When the center tone is set to other than "CENTER TONE: 3," the C.TONE indicator lights up on the display.

From the remote control:

You can also make adjustments the following way from the remote control.

Set the mode selector to "AUDIO/TV/VCR/DBS."

Press **SOUND**, then press **C.TONE** repeatedly.

NOTE

After pressing **SOUND**, the numeric buttons work for sound adjustments. To use the numeric buttons to operate your target source, press the corresponding source selecting button before operation; otherwise, the remote control may not work as you intend.

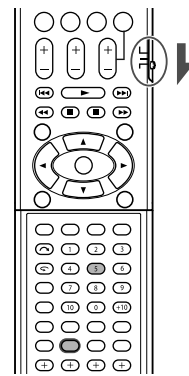

■ Align the vertical localization of the center channel —CENTER ALIGNMENT

This setting is available when one of the Surround/DSP modes (except "PLII MUSIC," "PLIIX MUSIC," "Neo:6 MUSIC," and "ALL CH ST") is in use. To activate Surround/DSP mode, see page 39.

- Once you have made an adjustment, it is memorized for each Surround/DSP mode.
- You cannot adjust the center alignment in the following cases:
 - When "CENTER SPEAKER" is set to "CENTER SPK: NO" (see page 21).
 - When Dual Mono software is played back.
 - While listening with the headphones.

C ALIGNMENT: ON Select when you cannot feel as if the actors or singers are speaking or singing on the screen.

C ALIGNMENT: OFF Select not to use this function.

Initial setting: C ALIGNMENT: OFF

Tuner operations

Tuner operations are mainly done from the remote control.

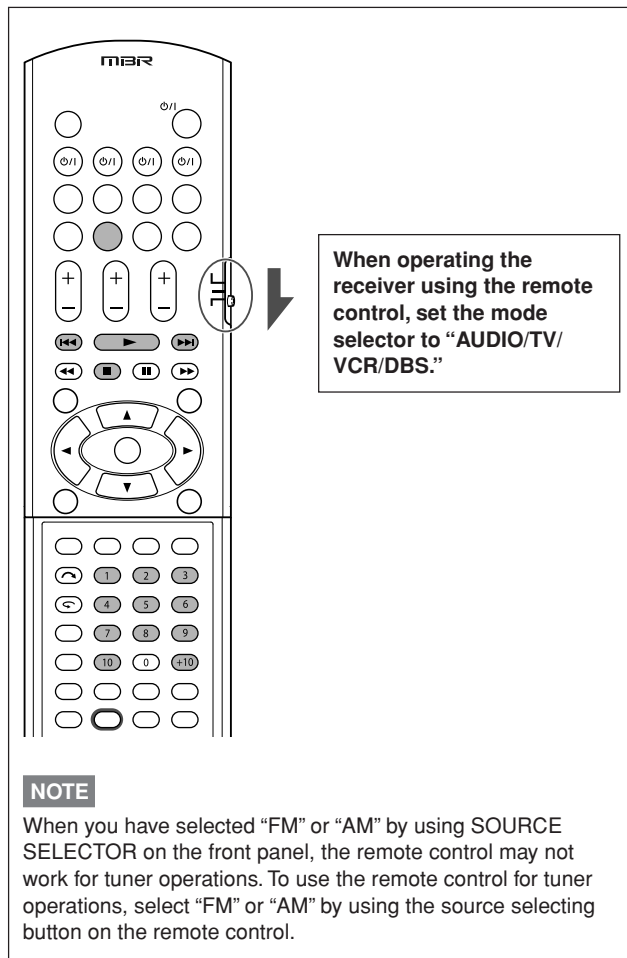

NOTE

When you have selected "FM" or "AM" by using SOURCE SELECTOR on the front panel, the remote control may not work for tuner operations. To use the remote control for tuner operations, select "FM" or "AM" by using the source selecting button on the remote control.

Setting the AM tuner interval spacing

Some countries space AM stations 9 kHz apart, and other countries use 10 kHz spacing. 9 kHz interval spacing is the initial setting.

- Be sure the receiver is turned off, but is plugged into an AC outlet when setting the AM tuner interval.

On the front panel ONLY:



To select the 10 kHz interval:

Hold down ADJUST and press ϕ/I STANDBY/ON. "10k STEP" appears on the display.

To change back to the 9 kHz interval:

Hold down SETTING and press ϕ/I STANDBY/ON. "9k STEP" appears on the display.

NOTE

When you change the AM tuner interval spacing, stored preset stations are erased. In this case, restore stations.

Tuning in to stations manually

From the remote control ONLY:

1 Press FM/AM to select the band.

The last received station of the selected band is tuned in.

- Each time you press the button, the band alternates between "FM" and "AM."

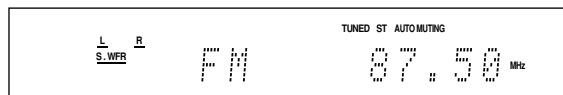

2 Press repeatedly or hold TUNING \oplus or \ominus TUNING until the station you want is tuned in.

- Pressing (or holding) TUNING \oplus increases the frequency.
- Pressing (or holding) \ominus TUNING decreases the frequency.

NOTES

- When you hold and release TUNING \oplus or \ominus TUNING, the frequency keeps changing until a station is tuned in.
- When a station of sufficient signal strength is tuned in, the TUNED indicator lights up on the display.
- When an FM stereo program is received, the ST (stereo) indicator also lights up.

Using preset tuning

Once a station is assigned a channel number, the station can be quickly tuned simply by selecting the number. You can preset up to 30 FM and 15 AM stations.

To store the preset stations

Before you start, remember...

There is a time limit in doing the following steps. If the setting is canceled before you finish, start from step 2 again.

From the remote control ONLY:

1 Tune in to the station you want to preset (see "Tuning in to stations manually" above).

- If you want to store the FM reception mode for this station, select the FM reception mode you want. See "Selecting the FM reception mode" on page 33.

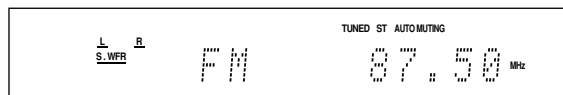

2 Press MEMORY.

The channel number position starts flashing on the display for about 5 seconds.

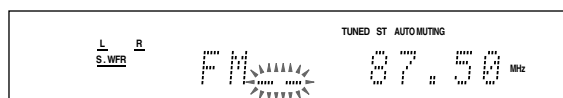

3 Press the numeric buttons (1 – 10, +10) to select a channel number while the channel number position is flashing.

- For channel number 5, press 5.
- For channel number 15, press +10, then 5.
- For channel number 30, press +10, +10, then 10.

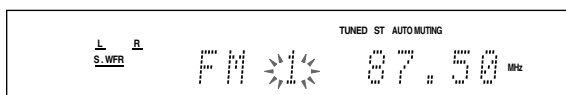

4 Press MEMORY again while the selected channel number is flashing on the display.

The selected channel number stops flashing.
The station is assigned to the selected channel number.

5 Repeat steps 1 to 4 until you store all the stations you want.

To erase a stored preset station

Storing a new station on a used channel number erases the previously stored one.

To tune in a preset station

From the remote control:

1 Press FM/AM to select the band.

The last received station of the selected band is tuned in and the numeric buttons now work for tuner operations.

- Each time you press the button, the band alternates between “FM” and “AM.”

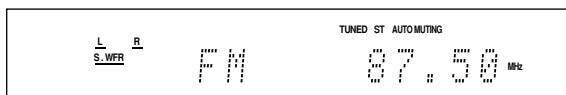

2 Press the numeric buttons (1 – 10, +10) to select a preset channel number.

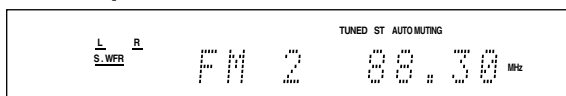

- For channel number 5, press 5.
- For channel number 15, press +10, then 5.
- For channel number 30, press +10, +10, then 10.

On the front panel:



Before you start, remember...

There is a time limit in doing the following steps. If the setting is canceled before you finish, start from step 2 again.

1 Turn SOURCE SELECTOR to select “FM” or “AM.”

The last received station of the selected band is tuned in.

2 Press TUNER PRESET.

“P” appears on the display and MULTI JOG now works for selecting preset channels.

3 Turn MULTI JOG to select a preset channel number while “P” appears on the display.

- To increase the preset channel numbers, turn MULTI JOG clockwise.
- To decrease the preset channel numbers, turn MULTI JOG counterclockwise.

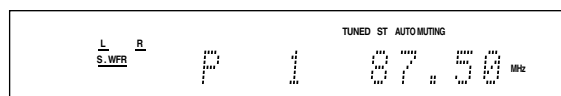

Selecting the FM reception mode

When an FM stereo broadcast is hard to receive or noisy, you can change the FM reception mode while receiving an FM broadcast.

- You can store the FM reception mode for each preset station (see page 32).

From the remote control ONLY:

While listening to an FM station, press FM MODE.

- Each time you press the button, the FM reception mode alternates between “AUTO MUTING” and “MONO.”

AUTO MUTING

Normally select this.
When a program is broadcast in stereo, you will hear stereo sound; when in monaural, you will hear monaural sound. This mode is also useful to suppress static noise between stations. The AUTO MUTING indicator lights up on the display.

MONO

Select this to improve the reception (but stereo effect will be lost).
In this mode, you will hear noise while tuning in to the stations. The AUTO MUTING indicator goes off from the display. (The ST indicator also goes off.)

Initial setting: AUTO MUTING

Creating realistic sound fields

Reproducing theater ambience

In a movie theater, many speakers are located on the walls to reproduce impressive multi-channel sound, reaching you from all directions.

With these many speakers, sound localization and sound movement can be expressed.

Surround/DSP modes built in this receiver can create almost the same Surround sound as you can feel in a real movie theater.

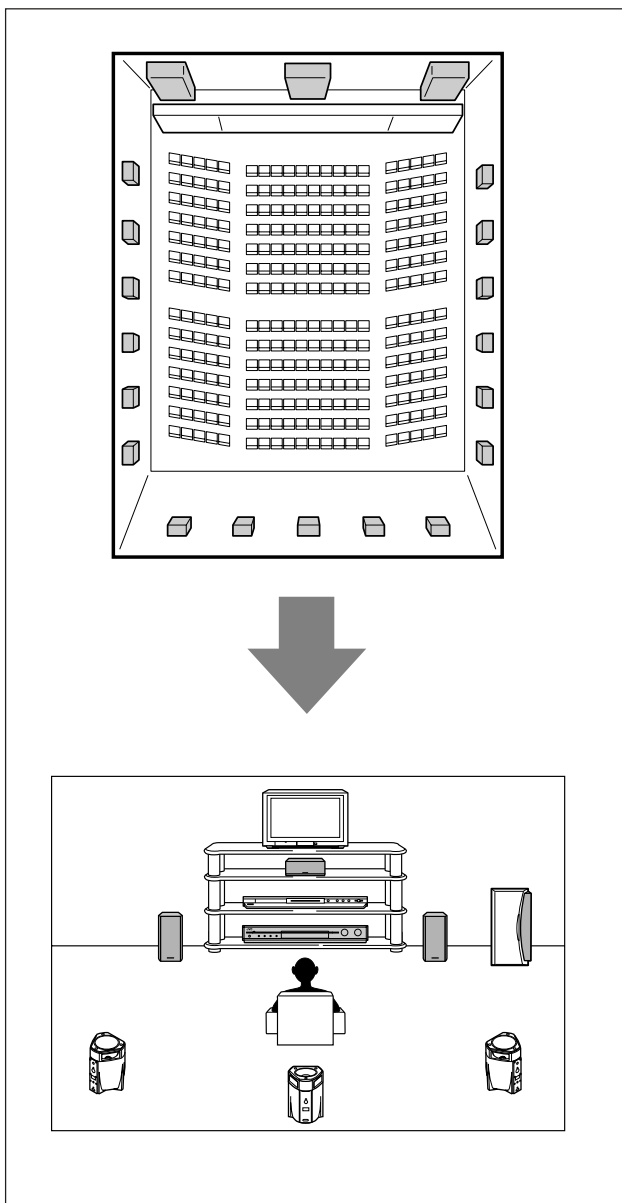

Introducing the Surround modes

■ Dolby Digital*

Dolby Digital is a digital signal compression method, developed by Dolby Laboratories, and enables multi-channel encoding and decoding.

- When Dolby Digital signal is detected through the digital input, the **DOLBY D** indicator lights up on the display.

Dolby Digital 5.1CH

Dolby Digital 5.1CH (DOLBY D) encoding method records and digitally compresses the left front channel, right front channel, center channel, left surround channel, right surround channel, and LFE channel signals (total 6 channels, but the LFE channel is counted as 0.1 channel. Therefore, called 5.1 channel).

Dolby Digital enables stereo surround sounds, and sets the cutoff frequency of the surround treble at 20 kHz, compared to 7 kHz for Dolby Pro Logic. As such, the sound movement and “being-there” feeling are enhanced much more than Dolby Pro Logic.

Dolby Digital EX

Dolby Digital EX (DOLBY D EX) is a digital surround encoding format that adds the third surround channels, called “surround back.”

Compared to the conventional Dolby Digital 5.1CH, these newly added surround back channels can reproduce more detailed movements behind you while viewing the video software. In addition, surround sound localization will become more stable.

■ Dolby Surround

Dolby Pro Logic II

Dolby Pro Logic II is a multi-channel playback format to convert 2-channel software into 5-channel (plus subwoofer). The matrix-based conversion method used for Dolby Pro Logic II makes no limitation for the cutoff frequency of the surround treble and enables stereo surround sound.

- This receiver provides two types of Dolby Pro Logic II modes—**Pro Logic II Movie** (PLII MOVIE) and **Pro Logic II Music** (PLII MUSIC).

When Dolby Pro Logic II is activated, the  **PL II** indicator lights up on the display.

PLII MOVIE Suitable for playing any Dolby Surround encoded software. You can enjoy a sound field very close to the one created with discrete 5.1-channel sounds.

PLII MUSIC Suitable for playing any 2-channel stereo software. You can enjoy wide and deep sounds.

Dolby Pro Logic IIx

Dolby Pro Logic IIx is a newly introduced multi-channel playback format to convert not only multi-channel software but 2-channel software into 6.1 channel (or 7.1 channel) that developed from Dolby Pro Logic II. The matrix-based conversion method used for Dolby Pro Logic IIx makes no limitation for the cutoff frequency of the surround treble.

- This receiver provides two types of Dolby Pro Logic IIx modes—**Pro Logic IIx Movie** (PLIIx MOVIE) and **Pro Logic IIx Music** (PLIIx MUSIC).

When Dolby Pro Logic IIx is activated, the  **PL IIx** indicator lights up on the display.

PLIIx MOVIE Suitable for playing any Dolby Surround encoded software. You can enjoy a sound field with a natural wraparound effect.

PLIIx MUSIC Suitable for playing any 2-channel stereo software. You can enjoy wide and deep 6.1-channel sounds.

- To enjoy software encoded with Dolby Digital, connect the source component using the digital terminal on the rear of this receiver. (See page 11.)

* Manufactured under license from Dolby Laboratories. "Dolby", "Pro Logic", and the double-D symbol are trademarks of Dolby Laboratories.

■ DTS**

DTS is another digital signal compression method, developed by Digital Theater Systems, Inc., and enables multi-channel encoding and decoding (1ch up to 6.1ch).

- When DTS signal is detected through the digital input, the **DTS** indicator lights up on the display.

DTS Digital Surround

DTS Digital Surround (DTS) is another discrete 5.1 channel digital audio format available on CD, LD, and DVD software. Compared to Dolby Digital, the DTS Digital Surround format has a lower audio compression rate which enables it to add breadth and depth to the sounds reproduced. As such, DTS Digital Surround features natural, solid, and clear sound.

DTS Extended Surround (DTS-ES)

DTS-ES is another multi-channel digital encoding format. It greatly improves the 360-degree surround impression and space expression by adding the third surround channel—surround back channel.

DTS-ES includes two signal formats with different surround signal recording methods—**DTS-ES Discrete 6.1ch** (ES DISCRETE) and **DTS-ES Matrix 6.1ch** (ES MATRIX).

DTS-ES Discrete 6.1ch has been designed to encode (and decode) a 6.1-channel signal discretely to avoid interference with each channel.

DTS-ES Matrix 6.1ch has been designed to add an extra surround channel to DTS Digital Surround 5.1-channel. By using a matrix encoding/decoding method, an additional "surround back" channel signal is encoded (and decoded) in both the left and right surround channel signals.

** "DTS", "DTS-ES", "Neo:6" and "DTS 96/24" are trademarks of Digital Theater Systems, Inc.

DTS 96/24

In recent years, there has been increasing interest in higher sampling rates both for recording and for reproducing at home. Higher sampling rates allow wider frequency range and greater bit depths provide extended dynamic range.

DTS 96/24 is a multi-channel digital signal format (fs 96 kHz/24 bits) introduced by Digital Theater Systems, Inc. to deliver "better-than-CD sound quality" into the home.

- When DTS 96/24 signal is detected, the **DTS** and **96/24** indicators light up. You can enjoy its 5.1-channel sound with full-quality.

DTS Neo:6

DTS Neo:6 is another conversion method to create 6-channel (plus subwoofer) from analog/digital 2-channel software by using the high precision digital matrix decoder used for DTS-ES Matrix 6.1ch.

- This receiver provides the following DTS Neo:6 modes—**Neo:6 Cinema** (NEO:6CINEMA) and **Neo:6 Music** (NEO:6 MUSIC). When one of them is activated, the **NEO:6** indicator lights up on the display.

NEO:6CINEMA Suitable for playing movies. You can get the same atmosphere with 2-channel software as with 6.1-channel software. It is also effective for playing software encoded with conventional surround formats.

NEO:6 MUSIC Suitable for playing music software. The front channel signals bypass the decoder (resulting in no loss of sound quality) and the surround signals transmitted through the other speakers expand the sound field naturally.

When using Surround mode, the sounds come out of the activated speakers which the Surround mode requires.

- **If either the surround speakers or center speaker is set to "NO" in the speaker setting (see page 21),** the corresponding channel signals are allocated to and emitted through the front speakers.
- **If both the surround speakers and center speaker are set to "NO" in the speaker setting (see page 21),** JVC's original 3D-PHONIC processing (which has been developed to create the surround effect through the front speakers only) is used. The 3D indicator lights up on the display.

3D HEADPHONE mode

If you connect a pair of headphones while one of the Surround modes is in use, the 3D HEADPHONE mode is activated without respect to the type of software played back. "3DHEADPHONE" appears on the display and the DSP, 3D, and HP indicators light up.

About other digital signals

Linear PCM

Uncompressed digital audio data used for DVDs, CDs, and Video CDs.

DVDs support 2 channels with sampling rates of 48/96 kHz, at quantization of 16/20/24 bits. On the other hand, CDs and Video CDs are limited to 2 channels with 44.1 kHz at 16 bits.

- When Linear PCM signal is detected, the LPCM indicator lights up.

Dual Mono

Dual Mono can be easily understood when you think of the bilingual broadcast for TV programs (however, the Dual Mono format is not identical with those analog formats).

This format is now adopted in Dolby Digital, DTS, and so on. It allows two independent channels (called main channel and sub-channel) to be recorded separately.

- You can select either channel you want to listen to (see page 23).

Introducing the DSP modes

The sound heard in a concert hall, club, etc. consists of direct sound and indirect sound—early reflections and reflections from behind. Direct sounds reach the listener directly without any reflection. On the other hand, indirect sounds are delayed by the distances of the ceiling and walls. These direct sounds and indirect sounds are the most important elements of the acoustic surround effects.

The DSP (Digital Signal Processor) modes can create these important elements, and give you a real “being there” feeling.

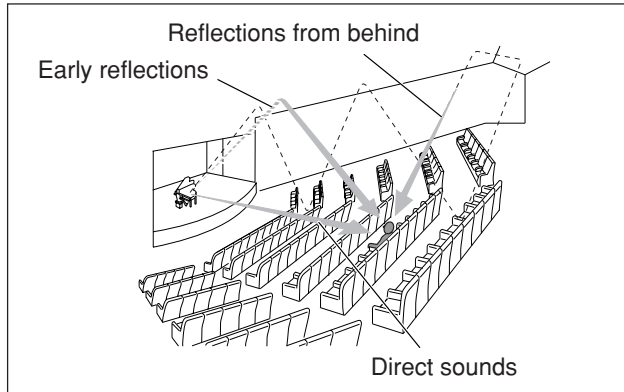

The DSP modes include the following modes:

- Digital Acoustic Processor (DAP) modes—HALL1, HALL2, LIVE CLUB, DANCE CLUB, PAVILION, THEATER1, THEATER2
- MONO FILM—Used for all types of 2-channel signals (including Dual Mono signal)
- All Channel Stereo mode (ALL CH ST)

When one of the DSP modes is activated, the DSP indicator lights up on the display.

Digital Acoustic Processor (DAP) modes

You can use the following DAP modes in order to reproduce a more acoustic sound field in your listening room.

HALL1	Reproduces the spatial feeling of a large shoebox-shaped hall designed primarily for classical concerts. (Its seating capacity is about 2000.)
HALL2	Reproduces the spatial feeling of a large vineyard-shaped hall designed primarily for classical concerts. (Its seating capacity is about 2000.)
LIVE CLUB	Reproduces the spatial feeling of a live music club with a low ceiling.
DANCE CLUB	Reproduces the spatial feeling of a rocking dance club.
PAVILION	Reproduces the spatial feeling of an exhibition hall with a high ceiling.
THEATER1	Reproduces the spatial feeling of a large theater where the seating capacity is about 600.
THEATER2	Reproduces the spatial feeling of a small theater where the seating capacity is about 300.

NOTE

When “THEATER1” or “THEATER2” is activated while playing back 2-channel analog or digital source, the built-in Dolby Pro Logic II decoder is activated and the indicator lights up.

When using the DAP mode, the sounds come out of all the connected and activated speakers.

- If the surround speakers are set to “NO” in the speaker setting (see page 21), JVC’s original 3D-PHONIC processing (which has been developed to create the surround effect through the front speakers only) is used. The 3D indicator lights up on the display.

MONO FILM

In order to reproduce a more acoustic sound field in your listening room while viewing monaural sound video software (analog and 2-channel digital signals including Dual Mono signal), you can use this mode.

The surround effect will be added, and the sound localization of actor’s words will be improved.

This mode cannot be used for multi-channel digital signals.

When “MONO FILM” is used, sounds come out of all the connected (and activated) speakers.

- If the surround speakers are set to “NO” in the speaker setting (see page 21), JVC’s original 3D-PHONIC processing (which has been developed to create the surround effect through the front speakers only) is used. The 3D indicator lights up on the display.
- If incoming signals change from 2-channel digital signal to another digital signal type, “MONO FILM” is canceled and an appropriate Surround mode is activated.

All Channel Stereo mode (ALL CH ST)

This mode can reproduce a larger stereo sound field using all the connected (and activated) speakers.

This mode cannot be used if the surround speakers are set to “NO” in the speaker setting (see page 21).

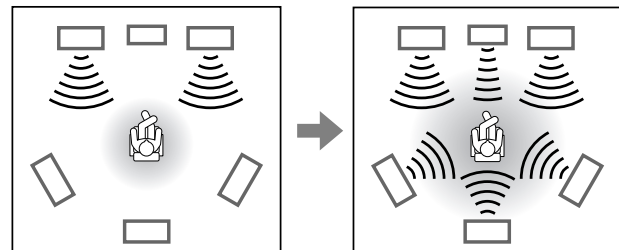

Sound reproduced from normal stereo

Sound reproduced from All Channel Stereo mode

3D HEADPHONE mode

If you connect a pair of headphones while one of the DSP modes is in use, the 3D HEADPHONE mode is activated without respect to the type of software played back. “3DHEADPHONE” appears on the display and the DSP, 3D, and HP indicators light up.

Using the Surround/DSP modes

Available Surround/DSP modes vary depending on the speaker settings and the incoming signals. See the table below.

- The numbers inside the parentheses following the incoming signal type indicate the number of the front channels and that of the surround channels. For example, (3/2) indicates that the signals are encoded with three front signals (left/right/center) and two (stereo) surround signals.
- For EX/ES/PLIIx setting, see page 22.

The name of the mode shown below is the display indication.

Incoming Signal Type		EX/ES/PLIIx setting				
		AUTO	ON	PLIIx MOVIE	PLIIx MUSIC	OFF
Dolby Digital	Dolby Digital Surround EX	DOLBY D EX*2*5	DOLBY D EX*2	DOLBY D EX*2*3	D + PLIIx MU*2	DOLBY D
	Dolby Digital (3/2, 2/2)	DOLBY D	DOLBY D EX*2	DOLBY D EX*2*3	D + PLIIx MU*2	DOLBY D
	Dolby Digital (3/1, 2/1, 3/0, 1/0)	DOLBY D				
	Dolby Digital (Dual Mono)	DUAL MONO				
DTS	DTS-ES Discrete*1	ES DISCRETE*2	ES DISCRETE*2	DTS + D EX*2*3	DTS + PLIIx MU*2	DTS
	DTS-ES Matrix*1	ES MATRIX*2	ES MATRIX*2	DTS + D EX*2*3	DTS + PLIIx MU*2	DTS
	DTS (3/2, 2/2)*1	DTS	DTS + NEO:6*2	DTS + D EX*2*3	DTS + PLIIx MU*2	DTS
	DTS (3/1, 2/1, 3/0, 1/0)	DTS				
	DTS (Dual Mono)	DUAL MONO				
Dolby Digital (2/0) DTS (2/0) Lenear PCM Analog		PLIIx MOVIE*4/PLIIx MUSIC*4/NEO:6CINEMA/NEO:6 MUSIC				PLII MOVIE PLII MUSIC NEO:6CINEMA NEO:6 MUSIC
DVD MULTI		None				

*1 DTS 96/24 processing is not applied when the EX/ES/PLIIx setting is activated. If you want to apply the processing, set the EX/ES/PLIIx setting to "EX/ES/PLIIx: OFF" (see page 22).

*2 When "SURROUND BACK SPEAKER" is set to "SURR. BACK SPK: NO" (see page 21), Virtual Surround Back is activated for the modes.

*3 When using PLIIx Movie to reproduce Dolby Digital or DTS software, this receiver applies Dolby Digital EX (DOLBY D EX) or DTS plus Dolby Digital EX (DTS + D EX) processing (6.1-channel reproduction) to the software.

*4 When "SURROUND BACK SPEAKER" is set to "SURR. BACK SPK: NO" (see page 21), "PLIIx MOVIE" is changed to "PLII MOVIE" and "PLIIx MUSIC" is changed to "PLII MUSIC."

*5 For some Dolby Digital Surround EX software, Dolby Digital 5.1-channel reproduction ("DOLBY D") may be applied. In this case, select "EX/ES/PLIIx: ON" to apply "DOLBY D EX."

About the DSP modes

- The following DSP modes are available regardless of incoming signal type:
HALL1, HALL2, LIVE CLUB, DANCE CLUB, PAVILION, THEATER1, THEATER2
- When an incoming signal is a multi-channel (more than 2-channel) digital signal, "MONO FILM" is not available.
- You cannot select "ALL CH ST" when the surround speakers are set to "NO" in the speaker setting (see page 21).

Virtual Surround Back

This function creates the great surround effect from the behind as if you have connected the surround back speaker. The VIRTUAL SB (Surround Back) indicator lights up on the display.

If you have connected (and activated) the surround speakers, you can use Virtual Surround Back without connecting the surround back speaker.

Virtual Surround Back is activated when "EX/ES/PLIIx" is set to other than "EX/ES/PLIIx: OFF" and when playing back the software including the following signals:

- Dolby Digital Surround EX
- DTS-ES
- Dolby Digital or DTS with more than 4-channels

Virtual Surround Back is activated when one of the Surround modes is selected.

Activating the Surround/DSP modes

Available Surround/DSP modes vary depending on the incoming signals. For details, see page 38.

Activating one of the Surround/DSP modes automatically recalls the memorized settings and adjustments.

- To adjust the speaker output level, see page 29.
- To adjust the effect level for the DSP mode (except All Channel Stereo mode,) see page 31.
- To add “wraparound” sound effect to “PLII MUSIC” (PANORAMA control,) see page 31.
- To adjust the sound localization of the center channel for “NEO:6 MUSIC” (center gain,) see page 31.
- To adjust the vertical localization of the center channel for Surround/DSP modes (except “PLII MUSIC,” “PLIIX MUSIC,” “Neo6: MUSIC,” and “ALL CH ST”) (center alignment,) see page 31.

NOTES

- You cannot use any Surround/DSP modes when selecting “DVD MULTI” as the playback source.
- The on-screen display appears on the TV screen to show the Surround/DSP mode name for 5 seconds when you select the Surround/DSP mode.
To cancel the function, set “SUPERIMPOSE” to “SUPERIMPOSE: OFF” (see page 25).

From the remote control:

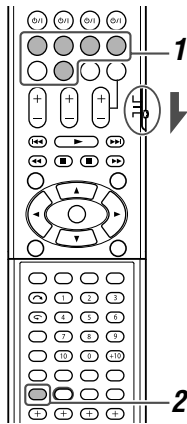

When operating the receiver using the remote control, set the mode selector to “AUDIO/TV/VCR/DBS.”

1 Select and play any source other than “DVD MULTI.”

- Make sure you have selected the input mode (analog or digital) correctly.

2 Press SURROUND repeatedly to select the Surround/DSP mode you want.

Ex.: When “DOLBY D” is selected for Dolby Digital multi-channel software:

DOLBY D

AUTO SURR	→ Surround modes*	→
HALL1	→ HALL2	→
LIVE CLUB	→ DANCE CLUB	→
PAVILION	→ THEATER1	→
THEATER2	→ MONO FILM	→
ALL CH ST	→ SURR OFF	→

(Back to the beginning)

To cancel Surround/DSP modes

Press SURROUND repeatedly so that “SURR OFF” appears on the display.

On the front panel:

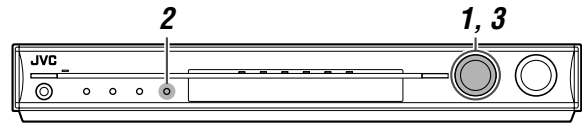

Before you start, remember...

There is a time limit in doing the following steps. If the setting is canceled before you finish, start from step 2 again.

1 Select and play any source other than “DVD MULTI.”

- Make sure you have selected the input mode (analog or digital) correctly.

2 Press SURROUND.

MULTI JOG now works for selecting Surround/DSP modes.

3 Turn MULTI JOG to select the Surround/DSP mode you want.

Ex.: When “DOLBY D” is selected for Dolby Digital multi-channel software:

DOLBY D

AUTO SURR	↔ Surround modes*	↔
HALL1	↔ HALL2	↔
LIVE CLUB	↔ DANCE CLUB	↔
PAVILION	↔ THEATER1	↔
THEATER2	↔ MONO FILM	↔
ALL CH ST	↔ SURR OFF	↔

(Back to the beginning)

To cancel Surround/DSP modes

Turn MULTI JOG so that “SURR OFF” appears on the display.

NOTE

The initial setting is “AUTO SURR.”

- * Available Surround modes vary depending on the incoming signals. For details, see “Using the Surround/DSP modes” on page 38.

When you select “AUTO SURR” (Auto Surround)

You can enjoy the Surround mode easily.

- For details about the Surround modes, see pages 34 to 36.
- When “AUTO SURR” is activated, the AUTO SR indicator lights up on the display.

How does “AUTO SURR” work?

- If a multi-channel signal comes in, an appropriate Surround mode will be selected automatically.
- If a Dolby Digital 2-channel or DTS 2-channel signal with surround signal comes in, “PLII MOVIE” will be selected.
- If a Dolby Digital 2-channel or DTS 2-channel signal without surround signal, or a Linear PCM signal comes in, “SURR OFF (stereo)” will be selected.

NOTES

- “AUTO SURR” does not take effect in the following cases:
 - While playing an analog source.
 - While selecting one of the fixed digital decode modes—“DOLBY D” or “DTS” (see page 13).
- While listening with the headphones, the 3D HEADPHONE mode (see pages 36 and 37) is activated without respect to the type of software played back.
- When “AUTO SURR” is selected, sound may not come out at the beginning of playback. If it occurs, select a Surround mode manually.

AV COMPU LINK remote control system

The AV COMPU LINK remote control system allows you to operate JVC's video components (TV, DVD player*, and VCR) through this receiver.

This receiver is equipped with the AV COMPU LINK-III, which has added a function to operate JVC's video components through the component video jacks. To use this remote control system, you need to connect the video components you want to operate, following the diagrams below and the procedures on page 41.

• Refer also to the manuals supplied with your video components.

* "DVD player" on pages 40 and 41 can be replaced with "DVD recorder."

Connections 1: AV COMPU LINK connection

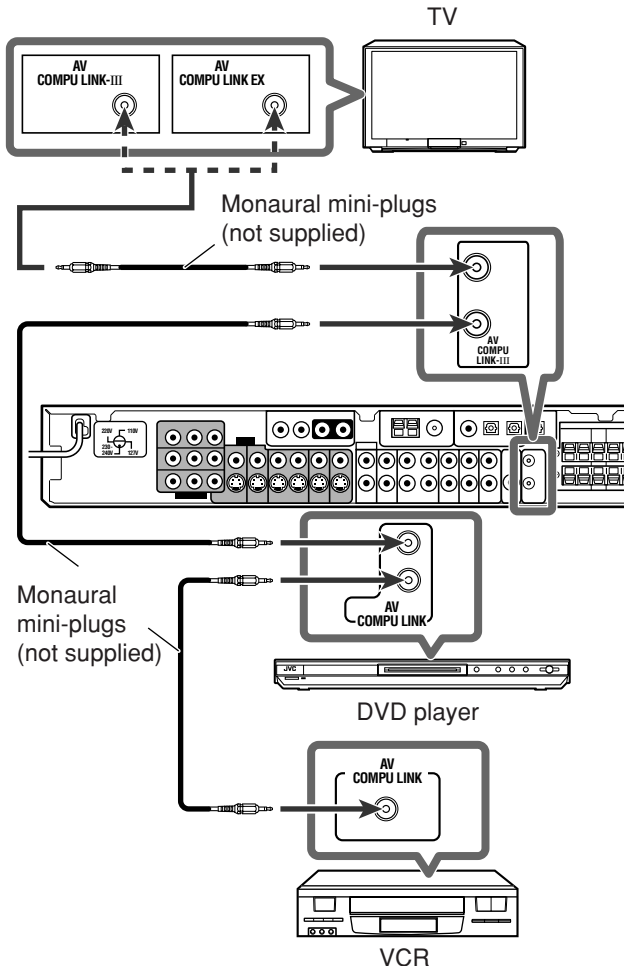

IMPORTANT:

The AV COMPU LINK remote control system cannot control the DBS tuner connected to the DBS IN jacks.

NOTES

- When connecting the receiver and a TV with the AV COMPU LINK EX terminal by using a component video cable, you cannot use Automatic selection of TV's input mode (see page 41).
- When connecting only the VCR and DVD player to this receiver, connect it directly to the receiver using cable with the monaural mini-plugs.
- You can connect only the TV with AV COMPU LINK EX or AV COMPU LINK-III terminal to the AV COMPU LINK-III terminal.

Connections 2: Video cable connection

This receiver is equipped with three types of the video terminals—composite video, S-video, and component video, and the signals coming into this receiver through one type of video terminals can output only through the terminal of the same type. So you need to connect the video components to this receiver using one of the following three ways.

- When using the AV COMPU LINK remote control system, set the video input for the DVD player and the VCR correctly (see "Selecting the component video input mode—DVD VIDEO INPUT/VCR VIDEO INPUT" on page 25); otherwise, the correct input for this receiver will not be selected on the TV.

Case 1*:

When connecting the source equipment to the receiver through the S-video terminals, connect this receiver to the TV's video input 1 terminal using S-video cables.

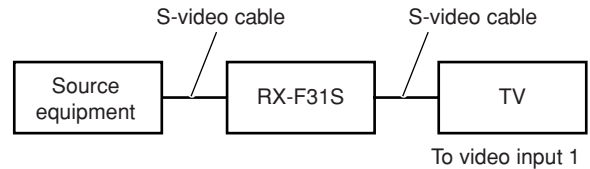

Case 2*:

When connecting the source equipment to the receiver through the composite video jacks, connect this receiver to the TV's video input 2 terminal (composite video input) using composite video cables.

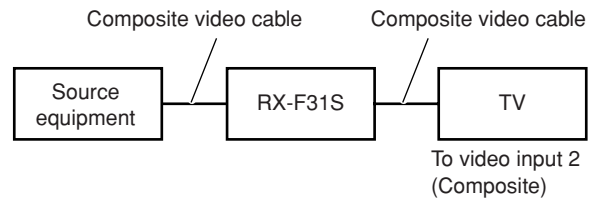

Case 3:

When connecting the source equipment to the receiver through the component video jacks, connect this receiver to the TV's video input 2 terminals (component video input) using component video cables.

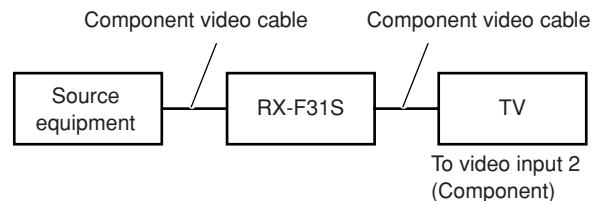

- * When using the AV COMPU LINK remote control system, set "DOWN MIX" and "Y/C SEPARATE" to "OFF"; otherwise, this system does not work correctly. For details about each setting, see page 25.

Connecting procedure

- 1 If you have already plugged your VCR, DVD player, TV, and this receiver into the AC outlets, unplug their AC power cords first.**
- 2 Connect your VCR, DVD player, TV, and this receiver as follows, using the cables with the monaural mini-plugs (not supplied).**
 - See "Connections 1" on the previous page.
- 3 Connect the audio input/output jacks on the VCR, DVD player, TV, and this receiver using the audio cables.**
 - See pages 7 to 10.
- 4 Connect the video input/output jacks on the VCR, DVD player, TV, and this receiver using the S-video cables, composite video cables, or component video cables.**
 - See "Connections 2" on the previous page.
- 5 Plug the AC power cords of the connected components and this receiver into the AC outlets.**
- 6 When turning on the TV for the first time after the AV COMPU LINK connection, turn the TV volume to the minimum using the TV volume control on the TV.**
- 7 Turn on other connected components first, then turn on this receiver.**
 - When turning on the VCR, use the remote control supplied with this receiver (press VCR \odot /I).

The AV COMPU LINK remote control system allows you to use the five basic functions listed below.

Remote control of the TV, DVD player, and VCR using this remote control

See pages 42 and 43 for details.

- Aim the remote control directly at **the remote sensor on each component.**

One-touch video play

Simply by inserting a video cassette without its safety tab into the VCR, you can enjoy the video playback without setting other switches manually. The receiver automatically turns on and changes the source to "VCR" (or "VCR DIGITAL").

The TV automatically turns on and changes the input mode to the appropriate position so that you can view the playback picture. When you insert a video cassette with its safety tab, press the play (▶) button on the VCR or on the remote control. So, you can get the same result.

One-touch DVD play

Simply by starting playback on the DVD player, you can enjoy the DVD playback without setting other switches manually.

- When the DVD player is connected through the analog input jacks on this receiver (and analog input is selected), the receiver automatically turns on and changes the source to "DVR/DVD" or "DVD MULTI."
- When the DVD player is connected through the digital input terminal on this receiver (and digital input is selected), the receiver automatically turns on and changes the source to "DVR/DVD DGT."

The TV automatically turns on and changes the input mode to the appropriate position so that you can view the playback picture.

Automatic selection of TV's input mode

- When you select "TV" (or "TV DIGITAL") as the source to play on the receiver, the TV automatically changes the input mode to the TV tuner so that you can watch TV.
- When you select "DVR/DVD" (or "DVR/DVD DGT"), "DVD MULTI," "VCR" (or "VCR DIGITAL"), or "DBS" (or "DBS DIGITAL") as the source to play on the receiver, the TV automatically changes the input mode to the appropriate position (either video input 1 or video input 2) so that you can view the playback picture.

NOTE

This function does not work when you connect this receiver and the TV with the AV COMPU LINK EX terminal using a component video cable. In this case, reconnect the TV referring to Case 1 or Case 2 on page 40.

Automatic power on/off

The TV, DVD player, and VCR turn on and off along with the receiver.

When you turn on the receiver;

- If the previously selected source is "TV" (or "TV DIGITAL") or "DBS" (or "DBS DIGITAL"), only the TV will turn on automatically.
- If the previously selected source is "DVR/DVD" (or "DVR/DVD DGT") or "DVD MULTI," the TV and DVD player will turn on automatically.
- If the previously selected source is "VCR" (or "VCR DIGITAL"), the TV and VCR will turn on automatically.

When you turn off the receiver, the TV, DVD player, and VCR will turn off.

NOTE

If you turn off the receiver while recording on the VCR, the VCR will not turn off, but continue recording.

Operating other JVC products

You can use the supplied remote control to operate not only this receiver but also other JVC products.

- Refer also to the manuals supplied with the other products. Some JVC VCRs can accept two types of the control signals—remote codes “A” and “B.”
 - When operating a VCR whose remote control code is set to “A,” set the manufacturer’s code to “01.”
 - When operating a VCR whose remote control code is set to “B,” set the manufacturer’s code to “02.”
 The initial setting is “01.” For details about the setting, see “Changing the transmittable signals for operating a VCR” on page 45.
- To operate other products, aim the remote control directly at the remote sensor on the target product.

TV

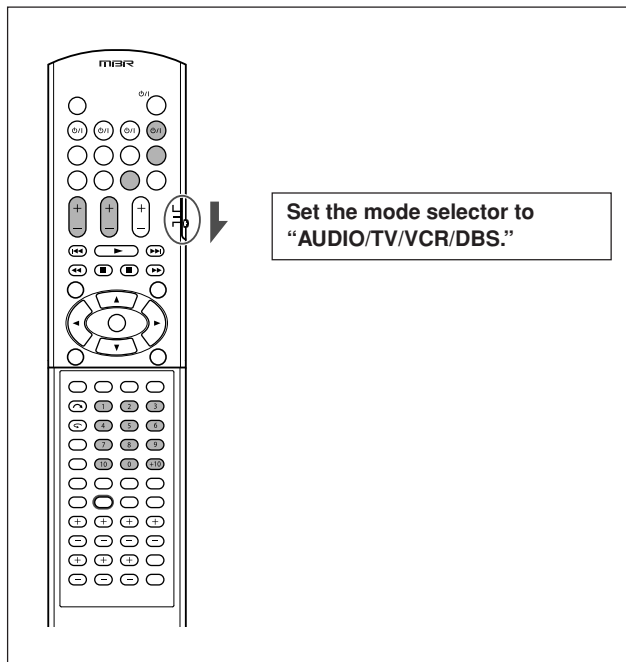

You can always perform the following operations:

TV \odot/I:	Turn on or off the TV.
TV VOL +/-:	Adjust the volume on the TV.
TV/VIDEO:	Change the input mode (either video input or TV tuner) on the TV.

After pressing TV, you can perform the following operations on the TV.

CHANNEL +/-:	Change the channel numbers.
1 – 9, 0, 100+:	Select the channel numbers.
TV RETURN (10):	Function as the TV RETURN button. (Switches between the previous channel and the current channel.)

VCR

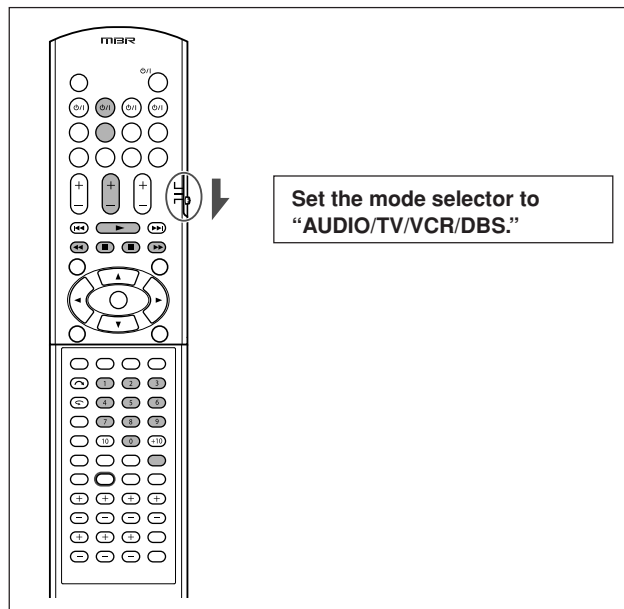

You can always perform the following operation:

VCR \odot/I:	Turn on or off the VCR.
---	-------------------------

After pressing VCR, you can perform the following operations on the VCR.

CHANNEL +/-:	Change the channel numbers on the VCR.
1 – 9, 0:	Select the channel numbers on the VCR.
▶:	Start playback.
■:	Stop playback.
 :	Pause playback. To release it, press ▶.
▶▶:	Fast-wind a tape.
◀◀:	Rewind a tape.
REC PAUSE:	Enter recording pause. To start recording, press this button then ▶.

DVD recorder or DVD player

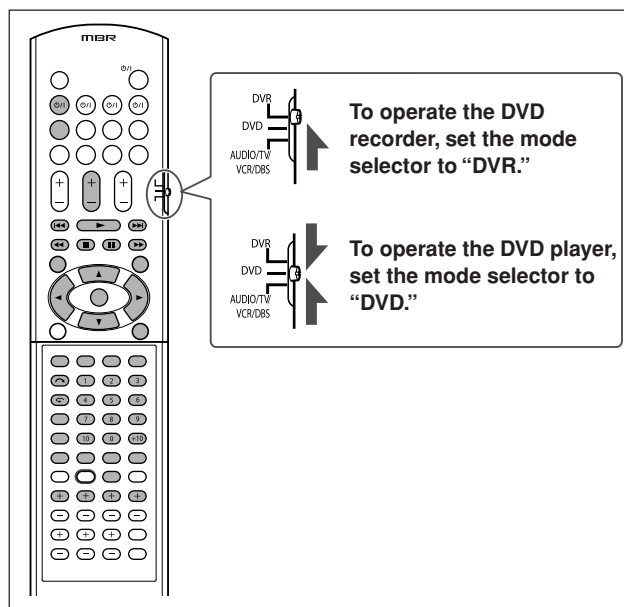

After setting the mode selector correctly, you can perform the following operations on the DVD recorder or DVD player.

See the instructions supplied with the DVD recorder or DVD player for details.

■ Changing the remote control code for DVD recorder

Some JVC DVD recorders can accept four types of the control signals. You can assign one of the four codes to the remote control supplied with this receiver for operating your DVD recorder. For details, refer to the manual supplied with the DVD recorder.

Initial setting: 03

- 1 Set the mode selector to "DVR."
- 2 Press and hold DVR/DVD \odot /I.
- 3 Press DVR/DVD.
- 4 Enter the remote control code you want using buttons 1 – 4, and 0.

EX.: To enter the code "2", press 0, then 2.

Code for DVR	Number to enter
1	01
2	02
3	03
4	04

5 Release DVR/DVD \odot /I.

Now, the remote control code has been changed.

You can always perform the following operation:

DVR/DVD \odot/I:	Turn on or off the DVD recorder or DVD player.
▶:	Start playback.
■:	Stop playback.
II:	Pause playback. To release it, press ▶.
▶▶:	Skip to the beginning of the next chapter.
◀◀:	Return to the beginning of the current (or previous) chapter.
▶▶▶:	Fast-forward playback.
◀◀◀:	Fast-reverse playback.
TOP MENU/MENU:	Display the menu recorded on discs.
ON SCREEN:	Shows the on-screen bar.
▲/▼/▶/◀:	Select an item on the menu screen.
ENTER:	Enter the selected item, channel number, chapter/title number, or track number (if required).

You can also use the following buttons to operate JVC DVD recorder and/or DVD player if it supports the corresponding function:

For various settings:

AUDIO:	Select the audio language/channel.
SUBTITLE:	Select the subtitle language.
SET UP:	Display the Preference display.
VFP:	Show the picture adjustment screen.
PROGRESSIVE*:	Change the scanning mode.
ANGLE:	Select the view angle.

For various playback:

↶ (one touch replay):	Move the playback position back 10 seconds before the current position.
RETURN:	Return to the main menu during menu operation.
CANCEL:	Cancel the programmed track, etc.

Only for DVD recorder operations:

CHANNEL +/-:	Change the channel numbers.
DVD/HDD:	Select the DVD recorder or HDD deck. (Only for a DVD recorder incorporated with HDD deck.)
↷ (skip):	Move the playback position ahead 30 seconds after the current position.
1 – 9, 0:	Select a channel number (while stopped) or a chapter/title number, track number (while playing back). Press ENTER to enter the number.
REC MODE:	Select the recording mode.
REC PAUSE:	Enter recording pause. To start recording, press ▶.
DISPLAY:	Change the display information.

Only for DVD player operations:

fs/Rate*:	Show the sampling frequency.
TITLE/GROUP:	Make the numeric buttons work for selecting the title/group number.
ZOOM:	Zoom in and out.
1 – 10, 0, +10:	Select a chapter/title number, track number, menu item, etc.
DVD/CARD:	Select the disc or memory card to play. (Only for a DVD player incorporated with memory card slots.)
DIMMER:	Change the display brightness.
THUMBNAIL:	Show the thumbnail screen for JPEG discs.
SLIDE:	Start the slide show playback for JPEG discs.
3D/S.EFFECT:	Apply the 3D effect.
PAGE:	Show browsable still pictures on DVD Audio discs.

* Press and hold when using these buttons.

If these buttons do not function normally, use the remote control supplied with your DVD recorder or DVD player. Refer also to the manuals supplied with the DVD recorder or DVD player for details.

Operating other manufacturers' products

By changing the transmittable signals, you can use the supplied remote control to operate other manufacturers' products.

- Refer also to the manuals supplied with the other products.
- To operate those components with the remote control, first you need to set the manufacturers' codes each for the TV, VCR, and DBS.
- After replacing batteries of the remote control, set the manufacturers' codes again.

□ Changing the transmittable signals for operating a TV

Set the mode selector to "AUDIO/TV/VCR/DBS."

1 Press and hold TV ϕ/I .

2 Press TV.

3 Enter the manufacturer's code using buttons 1 – 9, and 0.

See "Manufacturers' codes for TV" on the right.

4 Release TV ϕ/I .

Now, you can perform the following operations on the TV.

TV ϕ/I :	Turn on or off the TV.
TV VOL +/-:	Adjust the volume on the TV.
TV/VIDEO:	Change the input mode (either TV or VIDEO).

After pressing TV, you can perform the following operations on the TV.

CHANNEL +/-:	Change the channel numbers.
1 – 9, 0, 100+ (+10):	Select the channel numbers.

See the instructions supplied with the TV for details.

5 Try to operate your TV by pressing TV ϕ/I .

When your TV turns on or off, you have entered the correct code.

If more than one code is listed for your brand of TV, try each one until the correct one is entered.

Manufacturers' codes for TV

Manufacturer	Codes
JVC	01
Akai	02
Bell+Howell	03
Centurion	04
Coronad	05
Daewoo	06, 07, 08
Emerson	09, 10, 11, 12, 13
Fisher	14
GE•Pana	15, 16
GE•RCA	17
Gold Star	18, 19
Hitachi	20, 21
KTV	22, 23
Magnavox	24
Marantz	25
Mitsubishi	25
Panasonic	26, 27
Philips	24
Pioneer	28
Proscan	29
Quasar	30
Radioshack	31
RCA	02, 17, 32, 33, 34, 35
Samsung	36, 37
Sanyo	14
Sears	38
Sharp	39
Sony	40
Symphonic	41, 42
Toshiba	38
Zenith	43, 44

Initial setting: 01

Manufacturers' codes are subject to change without notice. If they are changed, this remote control cannot operate the equipment.

❑ Changing the transmittable signals for operating a VCR

Set the mode selector to "AUDIO/TV/VCR/DBS."

1 Press and hold VCR \odot/I .

2 Press VCR.

3 Enter the manufacturer's code using buttons 1 – 9, and 0.

See "Manufacturers' codes for VCR" on the right.

4 Release VCR \odot/I .

Now, you can perform the following operation on the VCR.

VCR \odot/I :	Turn on or off the VCR.
-------------------------------	-------------------------

After pressing VCR, you can perform the following operations on the VCR.

CHANNEL +/- :	Change the channel numbers on the VCR.
----------------------	--

1 – 9, 0 :	Select the channel numbers on the VCR.
-------------------	--

▶ :	Start playback.
------------	-----------------

■ :	Stop playback.
------------	----------------

⏸ :	Pause playback.
------------	-----------------

▶▶ :	Fast-wind a tape.
-------------	-------------------

◀◀ :	Rewind a tape.
-------------	----------------

See the instructions supplied with the VCR for details.

5 Try to operate your VCR by pressing VCR \odot/I .

When your VCR turns on or off, you have entered the correct code.

If more than one code is listed for your brand of VCR, try each one until the correct one is entered.

Manufacturers' codes for VCR

Manufacturer	Codes
JVC	01, 02, 03, 04
Aiwa	05
Akai	06, 07, 08
Bell+Howell	09
Daewoo	10
Emerson	11, 12, 13, 14, 15
Fisher	16, 17, 18, 19
G.E.	20, 21
Go Video	22
Gold Star	23
Go-Video A	24
Go-Video B	25
Hitachi	20, 26
Magnavox	27, 28, 29
Mitsubishi	30, 31, 32, 33
NEC	34, 35
Panasonic	36, 37
Philips	27
RCA	38
Samsung	39, 40, 41
Sanyo	16, 17, 18, 19
Scott	42
Sharp	43, 44
Shintom	45
Sony	46, 47, 48, 49, 50, 51
Symphonic	52
Teknica	53, 54
Toshiba	55
Zenith	56

Initial setting: 01

Manufacturers' codes are subject to change without notice. If they are changed, this remote control cannot operate the equipment.

❑ Changing the transmittable signals for operating a DBS tuner

Set the mode selector to "AUDIO/TV/VCR/DBS."

- 1 Press and hold DBS \odot/I .
- 2 Press DBS.
- 3 Enter the manufacturer's code using buttons 1 – 9, and 0.

See "Manufacturers' codes for DBS tuner" below.

4 Release DBS \odot/I .

Now, you can perform the following operation on the DBS tuner.

DBS \odot/I:	Turn on or off the DBS tuner.
---	-------------------------------

After pressing DBS, you can perform the following operations on the DBS tuner.

CHANNEL +/-:	Change the channel numbers on the DBS tuner.
1 – 9, 0:	Select the channel numbers on the DBS tuner.

See the instructions supplied with the DBS tuner for details.

5 Try to operate your DBS tuner by pressing DBS \odot/I .

When your DBS tuner turns on or off, you have entered the correct code.

If more than one code is listed for your brand of DBS tuner, try each one until the correct one is entered.

Manufacturers' codes for DBS tuner

Manufacturer	Codes
Echostar	40
G.I.	01, 41
Gemini	02
Hamlin	03, 04, 05, 06
Hitachi	42
Hughes	43
Jerrold	07, 08, 09, 10, 11, 12, 13, 14, 15
Macom	16, 17, 18
Magnavox	19
Oak	20, 21, 22
Panasonic	23, 24, 44
Philips	25, 26, 27, 28, 29, 30
Pioneer	31, 32
Primestar	45
RCA	46
S. Atlanta	33, 34, 35
Samsung	36
Sony	47
Tocom	37
Toshiba	48
Zenith	38, 39

Initial setting: 01

❑ Changing the transmittable signals for operating a DVD player

Set the mode selector to "DVD."

- 1 Press and hold DVR/DVD \odot/I .
- 2 Press DVR/DVD.
- 3 Enter the manufacturer's code using buttons 1 – 9, and 0.

See "Manufacturers' codes for DVD player" below.

4 Release DVR/DVD \odot/I .

Now, you can perform the following operation on the DVD player.

DVR/DVD \odot/I:	Turn on or off the DVD player.
▶:	Start playback.
◀◀:	Return to the beginning of the current chapter (or fast-forward for some models).
▶▶:	Skip to the beginning of the next chapter (or fast-reverse for some models).
■:	Stop playback.
⏸:	Pause playback.
MENU:	Display the menu recorded on DVD VIDEO discs.
▲/▼/▶/◀:	Select an item on the menu screen.
ENTER:	Enter the selected item.
1 – 9, 0:	Select the chapter number.

See the instructions supplied with the DVD player for details.

5 Try to operate your DVD player by pressing DVR/DVD \odot/I .

When your DVD player turns on or off, you have entered the correct code.

If more than one code is listed for your brand of DVD player, try each one until the correct one is entered.

Manufacturers' codes for DVD player

Manufacturer	Codes
JVC	01
Hitachi	12
Kenwood	05, 08
Mitsubishi	10
Onkyo	15, 16
Panasonic	04
Philips	07
Pioneer	03
Samsung	14
Sony	02
Toshiba	06
Yamaha	09

Initial setting: 01

NOTE

You cannot use this remote control to operate other manufacturers' DVD recorder.

Manufacturers' codes are subject to change without notice. If they are changed, this remote control cannot operate the equipment.

Troubleshooting

Use this chart to help you solve daily operational problems. If there are any problems you cannot solve, contact your JVC's service center.

	PROBLEM	POSSIBLE CAUSE	SOLUTION
Power	The power does not come on.	The power cord is not plugged in.	Plug the power cord into an AC outlet.
	The receiver turns off (enters standby mode).	Speakers are overloaded because of high volume.	1. Stop the playback source. 2. Turn on the receiver again, then turn the volume down.
		Speakers are overloaded because of a short circuit at the speaker terminals.	Check the speaker wiring. If speaker wiring is not short-circuited, contact your dealer.
		The receiver is overloaded because of a high voltage.	Consult your dealer after unplugging the power cord.
"OVER HEAT" flashes on the display, then the receiver turns off.	The receiver is overloaded because of high volume or long time usage.	Turn on the receiver again. If the receiver turns off soon, consult your dealer after unplugging the power cord.	
Sound and picture	No sound from speakers.	Speaker signal cables are not connected.	Check speaker wiring, then reconnect if necessary (see page 6) after unplugging the power cord.
		Connections are incorrect.	Check the audio connections (see pages 7 to 11) after unplugging the power cord.
		An incorrect source is selected.	Select the correct source.
		Muting is activated.	Press MUTING to cancel the mute (see page 15).
		An incorrect input mode (analog or digital) is selected.	Select the correct input mode (analog or digital).
	TV Direct is activated.	Deactivate TV Direct (see page 14).	
	Sound from one speaker only.	Speaker signal cables are not connected properly.	Check speaker wiring and reconnect if necessary (see page 6) after unplugging the power cord.
Bass sound is reinforced too much when listening in stereo.	Appropriate bass level is not selected.	Adjust audio position level (see page 14).	
Sounds are intermittently distorted or the noise is heard by the outside noise such as a lightning discharge.	The sounds may be intermittently distorted or the noise may be heard by the outside noise such as a lightning discharge but the sound will be restored automatically.	This is not a malfunction. But if this continues, turn on the receiver again.	
No picture is displayed on the monitor.	Connections are incorrect.	Check the video connections (see pages 7 to 10) after unplugging the power code.	
	Input mode is incorrect.	Check the component video input mode (see page 25).	
Remote control	Remote control does not operate as you intend.	The remote control is not ready for your intended operation.	Set the mode selector correctly, then press the corresponding source selecting button or SOUND before operation
	Remote control does not work.	There is an obstruction hiding the remote sensor on the receiver.	Remove the obstruction.
		Batteries are weak.	Replace batteries.
		The mode selector is set to the incorrect position.	Set the mode selector to the proper position.
Buttons cannot be used.	TV Direct is activated.	Deactivate TV Direct (see page 14).	
Tuner	Continuous hiss or buzzing during FM reception.	Incoming signal is too weak.	Connect an outdoor FM antenna or contact your dealer.
		The station is too far away.	Select another station.
		The wrong antenna is being used.	Check with your dealer to be sure you have the correct antenna.
		Antennas are not connected properly.	Check the connections.
	Occasional cracking noise during FM reception.	Ignition noise from automobiles.	Move the antenna farther from automobile traffic.

Specifications

Designs and specifications are subject to change without notice.

Amplifier

Output Power

At stereo operation:

Front channels: 100 W* per channel, min. RMS, driven into 6 Ω at 1 kHz with no more than 10% total harmonic distortion.

At surround operation:

Front channels: 100 W* per channel, min. RMS, driven into 6 Ω at 1 kHz with no more than 0.8% total harmonic distortion.

Center channel: 100 W*, min. RMS, driven into 6 Ω at 1 kHz, with no more than 0.8% total harmonic distortion.

Surround channels: 100 W* per channel, min. RMS, driven into 6 Ω at 1 kHz, with no more than 0.8% total harmonic distortion.

Surround back channel: 100 W*, min. RMS, driven into 6 Ω at 1 kHz, with no more than 0.8% total harmonic distortion.

* Measured on AC 110 V, 127 V, 220 V, and 240 V.

Audio

Audio Input Sensitivity/Impedance:

DVR/DVD (DVD MULTI), VCR, DBS, TV:
330 mV/47 k Ω

Audio Input (DIGITAL IN)*:

Coaxial: DIGITAL IN 1(DVR/DVD):
0.5 V(p-p)/75 Ω

Optical: DIGITAL IN 2(DBS), 3(VCR):
-21 dBm to -15 dBm
(660 nm \pm 30 nm)

* Corresponding to Linear PCM, Dolby Digital, and DTS (with sampling frequency—32 kHz, 44.1 kHz, 48 kHz).

Audio Output Level:

DVR, VCR, MONITOR OUT: 330 mV

Signal-to-Noise Ratio (*66 IHF/DIN): 80 dB/62 dB

Frequency Response (8 Ω): 20 Hz to 20 kHz (\pm 1 dB)

Bass Boost: +4 dB \pm 1 dB at 100 Hz

Equalization (at DSP operation):

Center frequency: 63 Hz, 250 Hz, 1 kHz, 4 kHz, 16 kHz
Control range: \pm 8 dB

Video

Video Input Sensitivity/Impedance:

Composite video: DVR/DVD, VCR, DBS:
1 V(p-p)/75 Ω

S-video: DVR/DVD, VCR, DBS:

Y (luminance): 1 V(p-p)/75 Ω

C (chrominance, burst): 0.286 V(p-p)/75 Ω

Component: DVR/DVD, VCR:

Y (luminance): 1 V(p-p)/75 Ω

PB, PR: 0.7 V(p-p)/75 Ω

Video Output Level/Impedance:

Composite video: DVR, VCR, MONITOR OUT:
1 V(p-p)/75 Ω

S-video: DVR, VCR, MONITOR OUT:

Y (luminance): 1 V(p-p)/75 Ω

C (chrominance, burst): 0.286 V(p-p)/75 Ω

Component: MONITOR OUT:

Y (luminance): 1 V(p-p)/75 Ω

PB, PR: 0.7 V(p-p)/75 Ω

Synchronization: Negative

FM tuner (IHF)

Tuning Range: 87.50 MHz to 108.00 MHz

Usable Sensitivity:

Monaural: 12.8 dBf (1.2 μ V/75 Ω)

50 dB Quieting Sensitivity:

Monaural: 16.0 dBf (1.7 μ V/75 Ω)

Stereo: 37.5 dBf (20.5 μ V/75 Ω)

Stereo Separation at OUT(REC): 35 dB at 1 kHz

AM tuner

Tuning Range: 531 kHz to 1 710 kHz (at 9 kHz intervals)
530 kHz to 1 710 kHz (at 10 kHz intervals)

General

Power Requirements: AC 110 V/127 V/220 V/230 V – 240 V \sim ,
adjustable with the voltage selector,
50 Hz/60 Hz

Power Consumption: 120 W (at operation)
5 W (in standby mode)

Dimensions (W x H x D): 435 mm x 70 mm x 317.2 mm

Mass: 6.3 kg

Mains (AC) Line Instruction (not applicable for Europe, U.S.A., Canada, and U.K.)

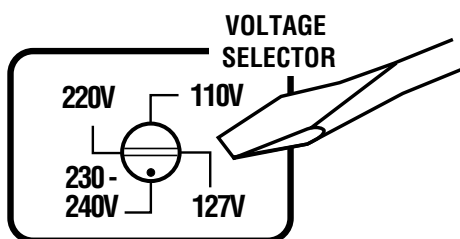
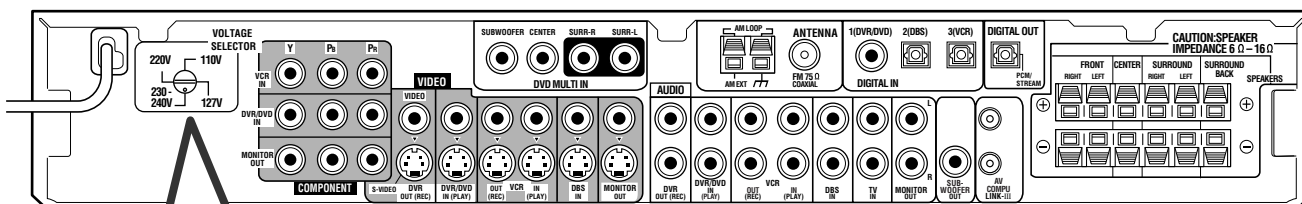

CAUTION for mains (AC) line

BEFORE PLUGGING IN, do check that your mains (AC) line voltage corresponds with the position of the voltage selector switch provided on the outside of this equipment and, if different, reset the voltage selector switch, to prevent from a damage or risk of fire/electric shock.

JVC

JVC



HOME CINEMA CONTROL CENTER

RX-F31S

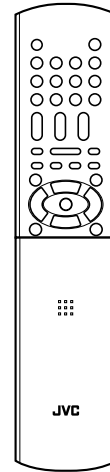
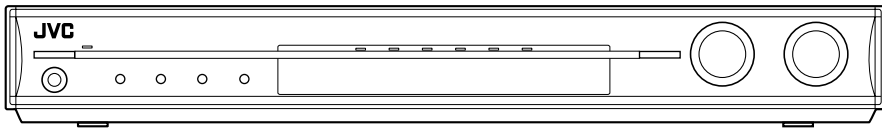

AV COMPU LINK

INSTRUCTIONS

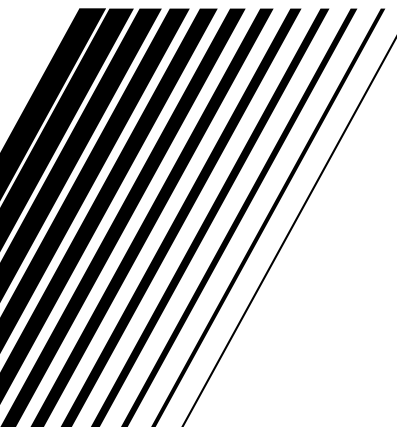

Warnings, Cautions, and Others

Caution— STANDBY/ON button!

Disconnect the mains plug to shut the power off completely. The  STANDBY/ON button in any position does not disconnect the mains line. The power can be remote controlled.

CAUTION

To reduce the risk of electrical shocks, fire, etc.:

1. Do not remove screws, covers or cabinet.
2. Do not expose this appliance to rain or moisture.

CAUTION

- Do not block the ventilation openings or holes.
(If the ventilation openings or holes are blocked by a newspaper or cloth, etc., the heat may not be able to get out.)
- Do not place any naked flame sources, such as lighted candles, on the apparatus.
- When discarding batteries, environmental problems must be considered and local rules or laws governing the disposal of these batteries must be followed strictly.
- Do not expose this apparatus to rain, moisture, dripping or splashing and that no objects filled with liquids such as vases, shall be placed on the apparatus.

Caution: Proper Ventilation

To avoid risk of electric shock and fire and to protect from damage.

Locate the apparatus as follows:

- Front: No obstructions open spacing.
Sides: No obstructions in 10 cm from the sides.
Back: No obstructions in 15 cm from the back.
Bottom: No obstructions, place on the level surface.

In addition, maintain the best possible air circulation as illustrated.

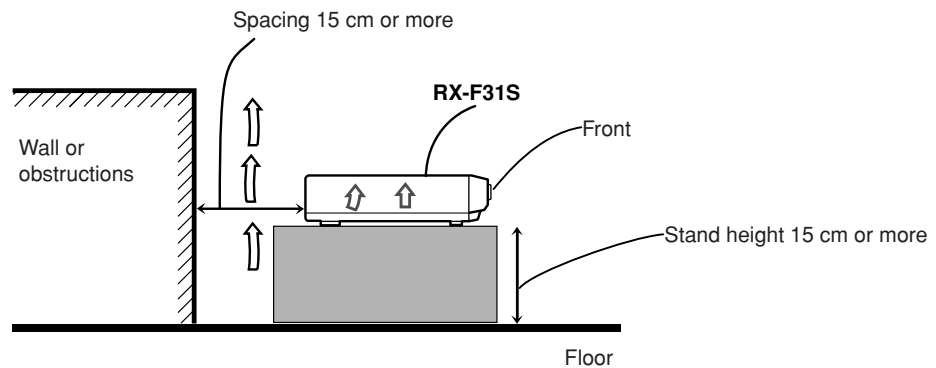
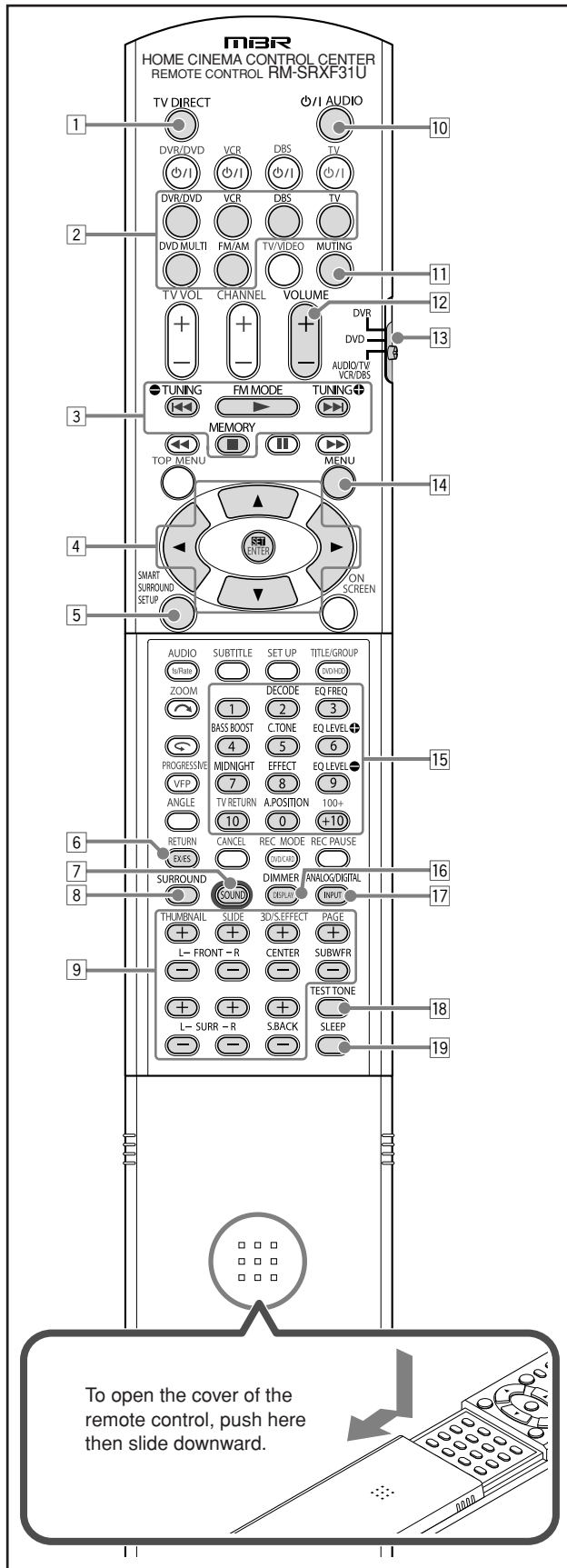

Table of Contents

Parts identification	2
Getting started	4
Before Installation	4
Checking the supplied accessories	4
Putting batteries in the remote control	4
Setting the voltage selector	4
Connecting the FM and AM antennas	5
Connecting the speakers	6
Connecting video components	7
Connecting the power cord	11
Basic operations	12
1 Turn on the power	12
2 Select the source to play	12
3 Adjust the volume	13
Selecting the digital decode mode	13
Adjusting the subwoofer audio position	14
Activating TV Direct	14
Turning off the sounds temporarily	15
Changing the display brightness	15
Turning off the power with the Sleep Timer	15
Basic settings	16
Setting the speaker information automatically	
—Smart Surround Setup	16
Basic setting items	18
Operation through on-screen display menus	18
Menu operation buttons	18
Setup menu configuration	19
Menu operating procedure	20
Setting the items	21
Setting the speakers	21
Activating the EX/ES/PLIIX setting—EX/ES/PLIIX	22
Selecting the main or sub channel—DUAL MONO	23
Setting bass sound	23
Using the Midnight mode—MIDNIGHT MODE	24
Setting the digital input (DIGITAL IN) terminals	
—DIGITAL IN 1/2/3	24
Selecting the component video input mode	
—DVD VIDEO INPUT/VCR VIDEO INPUT	25
Superimposing the menus—SUPERIMPOSE	25
Converting S-video signals into composite video signals	
—DOWN MIX	25
Converting composite video signals into S-video signals	
—Y/C SEPARATE	25
Sound adjustments	26
Basic adjustment items	26
Operation through on-screen display menus	26
Menu operation buttons	26
Setup menu configuration	27
Menu operating procedure	28
Adjusting the items	29
Adjusting speaker output level	29
Adjusting the equalization patterns	
—DIGITAL EQ 63Hz/250Hz/1kHz/4kHz/16kHz	30
Adjusting the bass sounds	30
Adjusting the sound parameters for the	
Surround/DSP modes	31
Tuner operations	32
Tuning in to stations manually	32
Using preset tuning	32
Selecting the FM reception mode	33
Creating realistic sound fields	34
Reproducing theater ambience	34
Introducing the Surround modes	34
Introducing the DSP modes	37
Using the Surround/DSP modes	38
Activating the Surround/DSP modes	39
AV COMPU LINK remote control system	40
Operating other JVC products	42
Operating other manufacturers' products	44
Troubleshooting	47
Specifications	48

Parts identification



Remote control

See pages in parentheses for details.

- 1 TV DIRECT button (14)
- 2 Source selecting buttons (12, 14, 32, 33)
DVR/DVD, VCR, DBS, TV, DVD MULTI, FM/AM
- 3 Operating buttons for tuner (32, 33)
TUNING, FM MODE, TUNING, MEMORY
- 4 On-screen display operation buttons (18, 26)
Cursor buttons (▶, ◀, ▲, ▼), **SET**
- 5 SMART SURROUND SETUP button (16)
- 6 EX/ES button (22)
- 7 SOUND button (13, 14, 22, 24, 30, 31)
- 8 SURROUND button (39)
- 9 Adjusting buttons for speaker and subwoofer output levels (29)
FRONT L +/-, FRONT R +/-, CENTER +/-, SUBWFR +/-,
SURR L +/-, SURR R +/-, S.BACK +/-
- 10 **φ/I** AUDIO button (12, 14)
- 11 MUTING button (15)
- 12 VOLUME +/- button (13)
- 13 Mode selector (12, 14, 16, 18, 22, 24, 26, 29 – 32, 39)
DVR, DVD, AUDIO/TV/VCR/DBS
- 14 MENU button (18, 26)
- 15 • Numeric buttons (33)
• Adjusting buttons (13, 14, 24, 30, 31)
DECODE, EQ FREQ, BASS BOOST, C.TONE,
EQ LEVEL, MIDNIGHT, EFFECT, EQ LEVEL, A.POSITION
- 16 DIMMER button (15)
- 17 ANALOG/DIGITAL INPUT button (12)
- 18 TEST TONE button (17, 29)
- 19 SLEEP button (15)

The buttons which are not indicated here can be used for operating other JVC products or other manufacturers' products. For details, see pages 42 to 46.

- When operating this receiver, set the mode selector (13) to "AUDIO/TV/VCR/DBS."
- When operating a JVC DVD recorder, set the mode selector (13) to "DVR."
- When operating a JVC DVD player, set the mode selector (13) to "DVD."

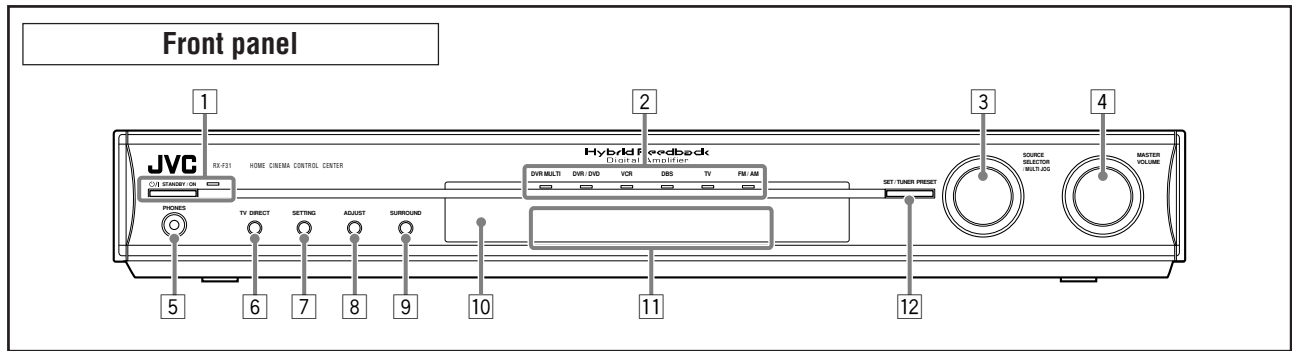

- | | |
|---|---|
| <ul style="list-style-type: none"> 1 Φ/I STANDBY/ON button and standby lamp (12, 14, 32) 2 Source lamps
DVD MULTI, DVR/DVD, VCR, DBS, TV, FM/AM 3 SOURCE SELECTOR (12, 14, 33)
• MULTI JOG (18, 26, 33, 39) 4 MASTER VOLUME control (13) 5 PHONES jack (13) 6 TV DIRECT button (14) | <ul style="list-style-type: none"> 7 SETTING button (18, 32) 8 ADJUST button (26, 32) 9 SURROUND button (39) 10 Remote sensor (4) 11 Display window (see below)
• SET button (17, 18, 26)
• TUNER PRESET button (33) |
|---|---|

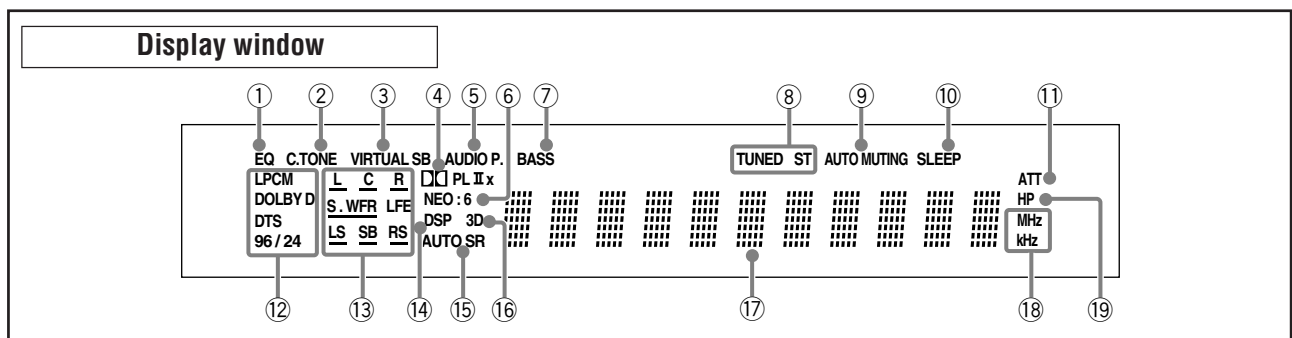

- | | |
|--|---|
| <ul style="list-style-type: none"> 1 EQ indicator (30) 2 C.TONE indicator (31) 3 VIRTUAL SB indicator (38) 4 $\square\square$ PL II and $\square\square$ PL IIx indicator (35) 5 AUDIO P. (position) indicator (14) 6 Neo:6 indicator (36) 7 BASS indicator (30) 8 Tuner operation indicators (32)
TUNED, ST (stereo) 9 AUTO MUTING indicator (33) 10 SLEEP indicator (15) | <ul style="list-style-type: none"> 11 ATT (attenuator) indicator (30) 12 Digital signal format indicators (13, 34 – 36)
LPCM (Linear PCM), DOLBY D (Dolby Digital), DTS, 96/24 13 Signal and speaker indicators (15) 14 DSP indicator (36, 37) 15 AUTO SR (surround) indicator (39) 16 3D indicator (36, 37) 17 Main display 18 Frequency unit indicators
MHz (for FM station), kHz (for AM station) 19 HP (headphones) indicator (13, 36, 37) |
|--|---|

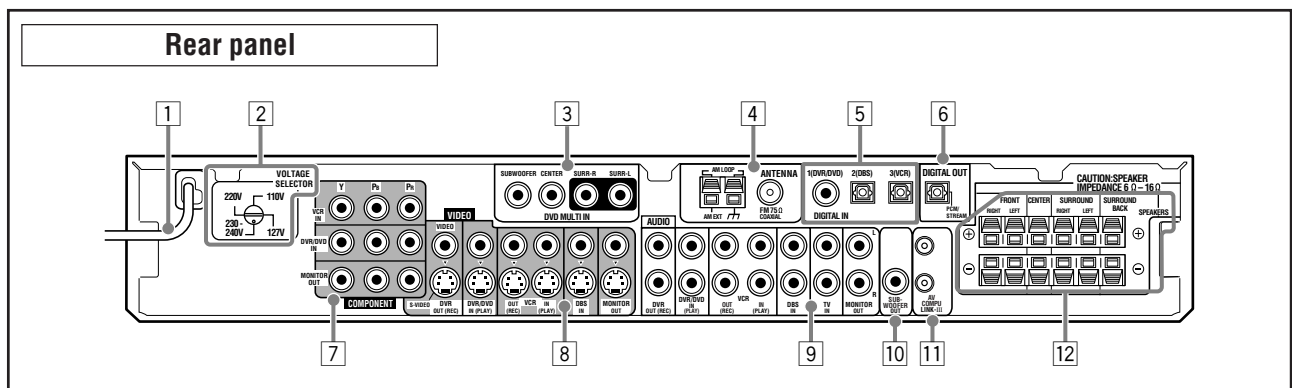

- | | |
|--|--|
| <ul style="list-style-type: none"> 1 Power cord (11) 2 VOLTAGE SELECTOR (4) 3 DVD MULTI IN jacks (8)
SUBWOOFER, CENTER, SURR-R, SURR-L 4 ANTENNA terminals (5) 5 DIGITAL IN terminals (11)
• Coaxial: 1(DVR/DVD)
• Optical: 2(DBS), 3(VCR) 6 DIGITAL OUT terminal (11) 7 COMPONENT (Y, Pb, Pr) jacks (7 – 10)
VCR IN, DVR/DVD IN, MONITOR OUT | <ul style="list-style-type: none"> 8 VIDEO terminals (7 – 10)
VIDEO (composite video) jacks, S-VIDEO terminals
• Input: DVR/DVD IN (PLAY), VCR IN (PLAY), DBS IN
• Output: DVR OUT (REC), VCR OUT (REC), MONITOR OUT 9 AUDIO jacks (7 – 10)
• Input: DVR/DVD IN (PLAY), VCR IN (PLAY), DBS IN, TV IN
• Output: DVR OUT (REC), VCR OUT (REC), MONITOR OUT 10 SUBWOOFER OUT jack (6) 11 AV COMPU LINK-III terminals (40) 12 SPEAKERS terminals (6)
FRONT, CENTER, SURROUND, SURROUND BACK |
|--|--|

Getting started

Before Installation

General precautions

- Be sure your hands are dry.
- Turn the power off to all components.
- Read the manuals supplied with the components you are going to connect.

Locations

- Install the receiver in a location that is level and protected from moisture and dust.
- The temperature around the receiver must be between -5°C and 35°C .
- Make sure there is good ventilation around the receiver. Poor ventilation could cause overheating and damage the receiver.
- Leave sufficient distance between the receiver and the TV.

Handling the receiver

- Do not insert any metal object into the receiver.
- Do not disassemble the receiver or remove screws, covers, or cabinet.
- Do not expose the receiver to rain or moisture.
- Do not pull on the power cord to unplug the cord. When unplugging the cord, always grasp the plug so as not to damage the cord.
- When you are away on travel or otherwise for an extended period or time, remove the plug from the wall outlet. A small amount of power is always consumed while the power cord is connected to the wall outlet.

The receiver has a built-in cooling fan which operates while the receiver is turned on. Be sure to leave enough ventilation to obtain sufficient cooling effect.

CAUTION:

Do not connect the AC power plug to the wall outlet until all connections are completed.

Checking the supplied accessories

Check to be sure you have all of the following supplied accessories. If anything is missing, contact your dealer immediately.

- Remote control (× 1)
- Batteries (× 2)
- AM loop antenna (× 1)
- FM antenna (× 1)
- Digital coaxial cable (× 1)

Putting batteries in the remote control

Before using the remote control, put two supplied batteries first.

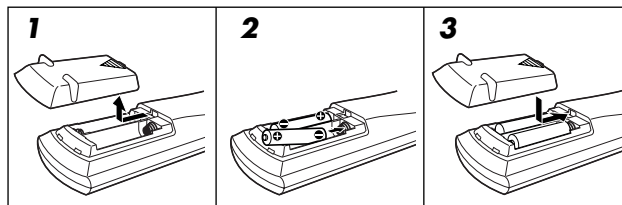

1 Press and slide the battery cover on the back of the remote control.

2 Insert batteries.

Make sure to match the polarity: (+) to (+) and (-) to (-).

3 Replace the cover.

If the range or effectiveness of the remote control decreases, replace the batteries. Use two R6(SUM-3)/AA(15F) type dry-cell batteries.

- Supplied batteries are for initial setup. Replace for continued use.

CAUTION:

Follow these precautions to avoid leaking or cracking cells:

- Place batteries in the remote control so they match the polarity: (+) to (+) and (-) to (-).
- Use the correct type of batteries. Batteries that look similar may differ in voltage.
- Always replace both batteries at the same time.
- Do not expose batteries to heat or flame.

When using the remote control, aim the remote control directly at the remote sensor on the front panel.

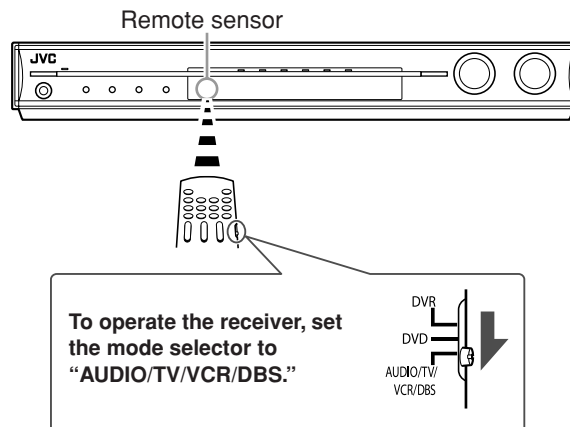

Setting the voltage selector

Before connections, always do the following first if necessary.

Select the correct voltage in **VOLTAGE SELECTOR** on the rear of the receiver by using a screw driver.

- Check to be sure if the voltage mark is set to the voltage for your area where this unit plugs in.

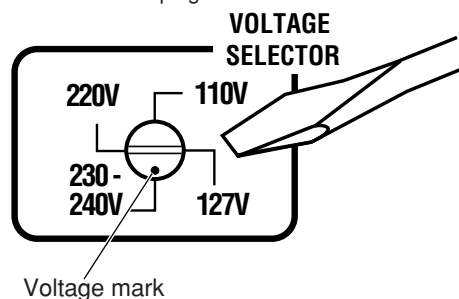

Connecting the FM and AM antennas

Do not connect the AC power plug to the wall outlet until all connections are completed.

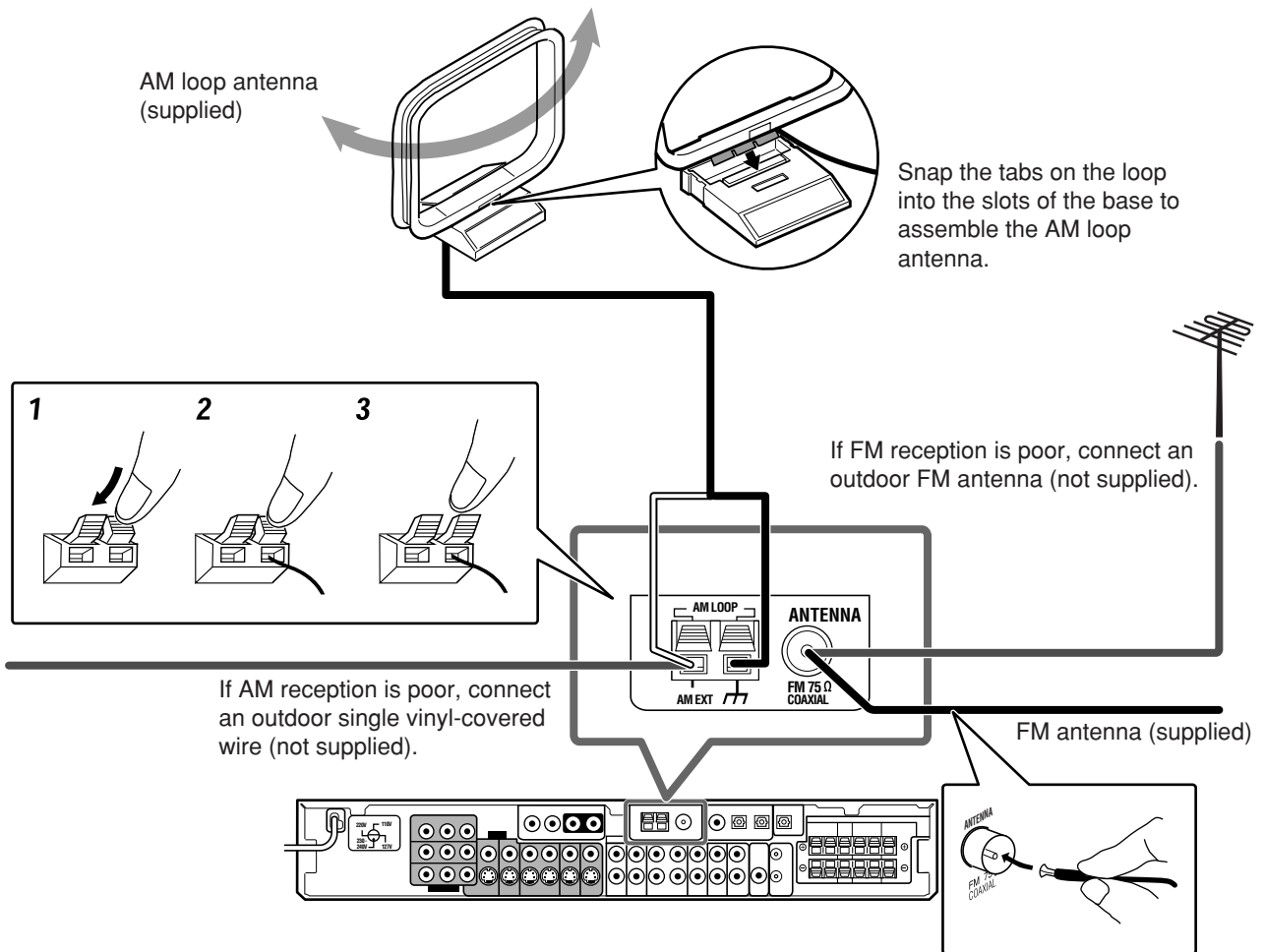

AM antenna connection

Connect the AM loop antenna supplied to the AM LOOP terminals.

Connect the white cord to the AM EXT terminal, and connect the black cord to the ⏏ terminal.

Turn the loop until you have the best reception.

- If the reception is poor, connect an outdoor single vinyl-covered wire (not supplied) to the AM EXT terminal. Keep the AM loop antenna connected.

FM antenna connection

Connect the FM antenna supplied to the FM 75 Ω COAXIAL terminal as a temporary measure.

Extend the supplied FM antenna horizontally.

- If the reception is poor, connect an outdoor FM antenna (not supplied). Before attaching a 75 Ω coaxial cable with a connector (IEC or DIN 45325), disconnect the supplied FM antenna.

NOTES

- If the AM loop antenna wire is covered with vinyl, remove the vinyl while twisting it as shown on the right.
- Make sure the antenna conductors do not touch any other terminals, connecting cords and power cord. This could cause poor reception.

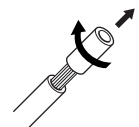

Connecting the speakers

Do not connect the AC power plug to the wall outlet until all connections are completed.

Speaker Layout Diagram

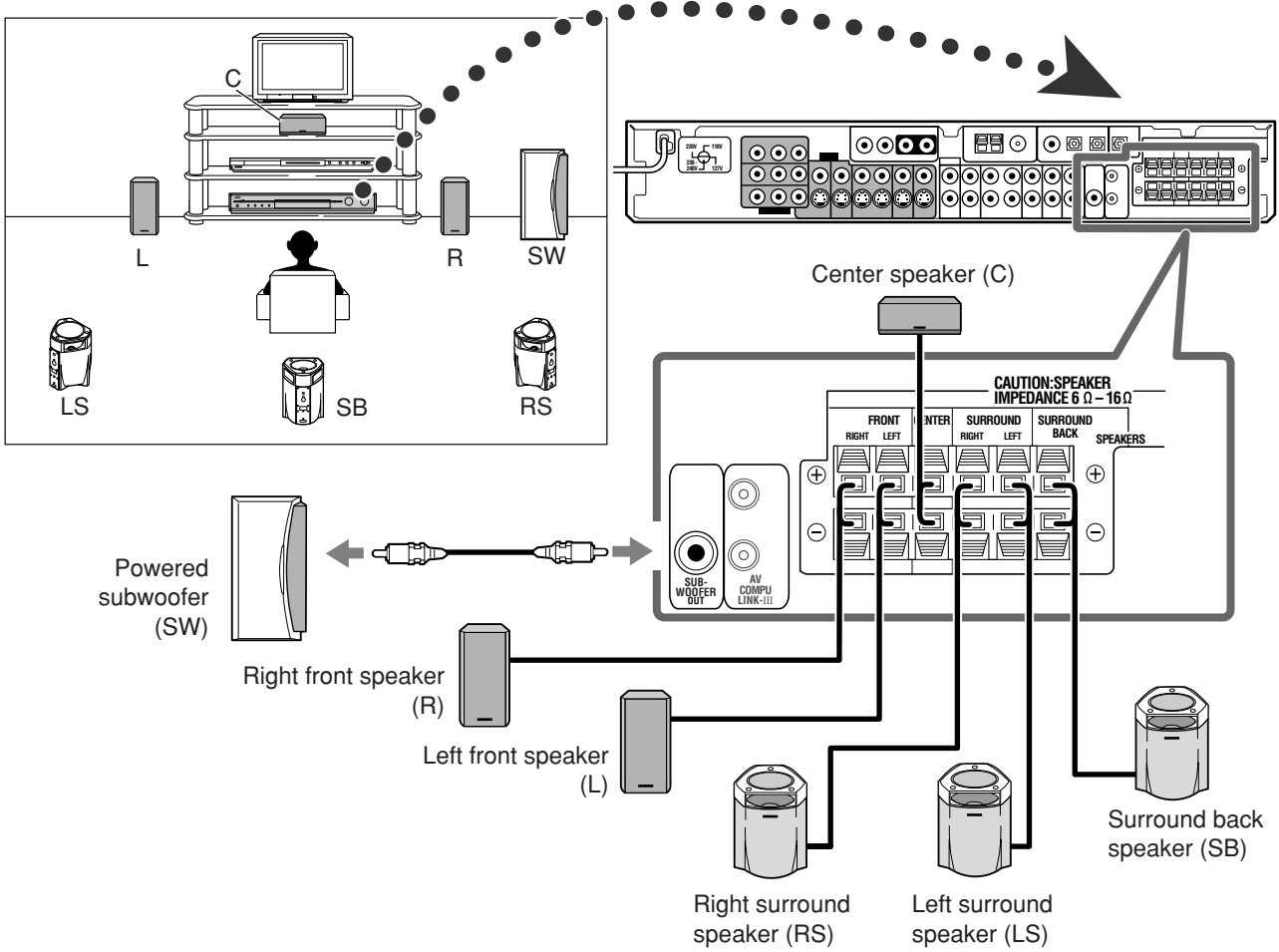

Connecting the speakers

Turn off all components before making connections.

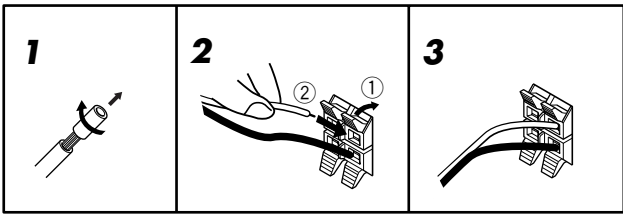

- 1** Twist and remove the insulation at the end of each speaker cord.
- 2** Press and hold the clamp of the speaker terminal (①), then insert the speaker cord (②).
 - For each speaker, connect the (+) and (-) terminals on the rear panel to the (+) and (-) terminals marked on the speakers.
- 3** Release the finger from the clamp.

CAUTIONS:

- Use speakers with the SPEAKER IMPEDANCE indicated by the speaker terminals (6 Ω – 16 Ω).
- DO NOT connect more than one speaker to one speaker terminal.

Connecting the powered subwoofer

By connecting a subwoofer, you can enhance the bass or reproduce the original LFE signals recorded in digital software.

Connect the input jack of a powered subwoofer to the SUBWOOFER OUT jack on the rear panel, using a cord with RCA pin plugs (not supplied).

- Refer also to the manual supplied with your subwoofer.

After connecting all the speakers and/or a subwoofer, set the speaker setting information properly to obtain the best possible surround effect. For details, see pages 16, 17, and 21 to 23.

NOTE

You can place a subwoofer wherever you like since bass sound is non-directional. Normally place it in front of you.

Connecting video components

Do not connect the AC power plug to the wall outlet until all connections are completed.

This receiver is equipped with the following video terminals—composite video, S-video, and component video terminals.

- If your video components have S-video (Y/C-separation) and/or component video (Y, P_B, P_R) jacks, connect them using an S-video cable (not supplied) or component video cable (not supplied). By using these terminals, you can get a better picture quality in the order:

Component > S-video > Composite

IMPORTANT:

Component video signals are transmitted only through component video output jacks. Therefore, if a recording video component and a playing video component are connected to the receiver through the video terminals of different type, you cannot record the picture. In addition, if the TV and a playing video component are connected to the receiver through the video terminals of different type, you cannot view the playback picture on the TV. On the other hand, S-video signals and composite video signals can be converted into each other and transmitted through the corresponding output jack. For details about the settings of the conversion, see page 25.

Turn off all components before making connections.

- When you connect other components, refer also to their manuals.

DO NOT use a TV through a VCR or a TV with a built-in VCR; otherwise, the picture may be distorted.

CAUTION:

If you connect a sound-enhancing device such as a graphic equalizer between the source components and this receiver, the sound output through this receiver may be distorted.

If your video components have AV COMPU LINK terminal

See also page 40 for detailed information about the connection and the AV COMPU LINK remote control system.

■ Connecting a DVD recorder or DVD player with its stereo output jacks (DVR/DVD):

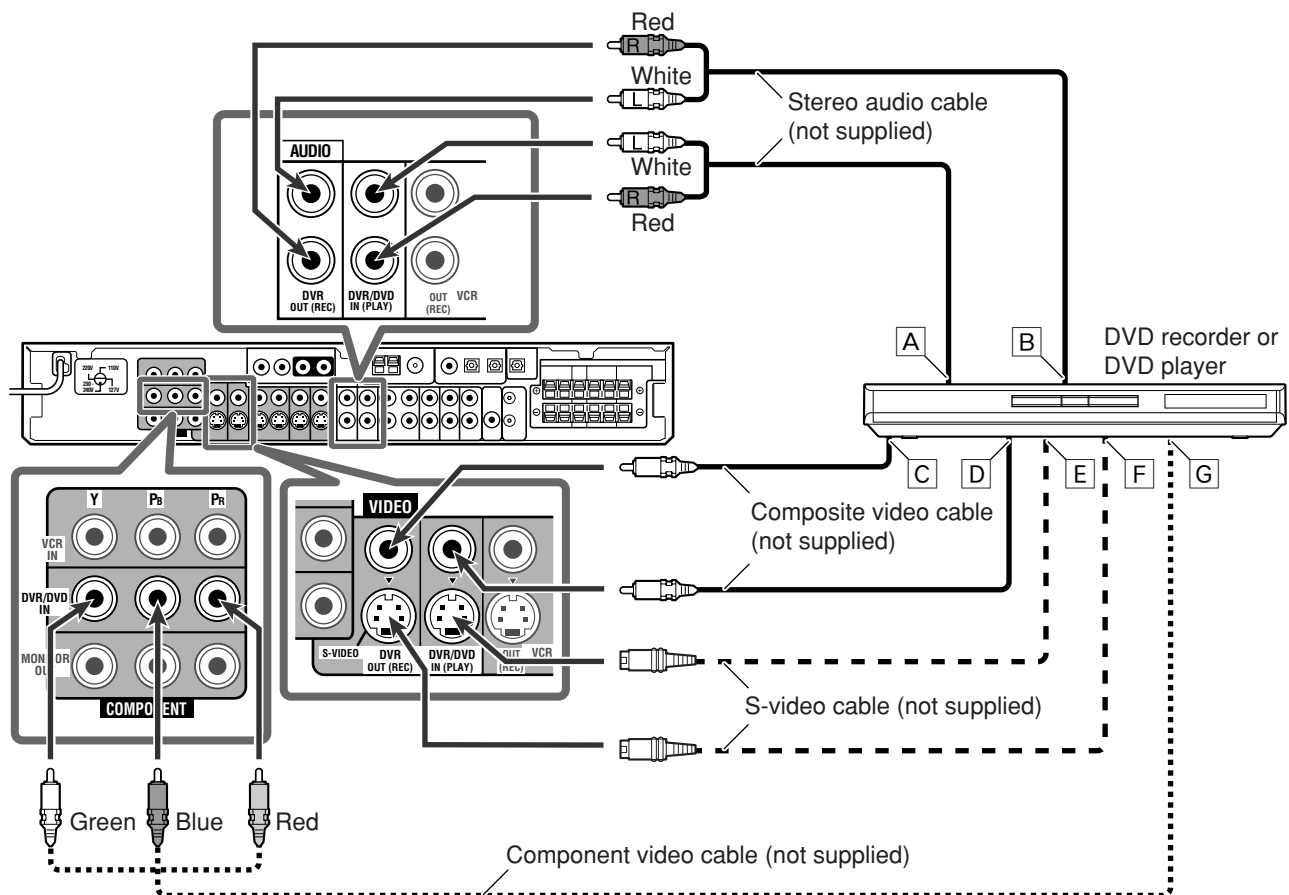

NOTES

- When connecting a DVD recorder or DVD player to the component video input jacks, make the component video input setting (DVD VIDEO INPUT) correctly. If you do not, you cannot view the playback picture on the TV or the AV COMPU LINK remote control system cannot operate properly. For details, see page 25.
- You can enjoy digital sound if using a digital coaxial or optical cable. When shipped from the factory, the audio input mode for a DVD recorder and DVD player is set to use the digital coaxial terminal (DIGITAL IN 1 (DVR/DVD)). For details of digital connection, see page 11.

- A To left/right audio channel output
- B **Only for DVD recorder:** To left/right audio channel input
- C **Only for DVD recorder:** To composite video input
- D To composite video output
- E To S-video output
- F **Only for DVD recorder:** To S-video input
- G To component video output
 - Connect Y, P_B, and P_R correctly.

■ Connecting a DVD recorder or DVD player with its analog discrete output jacks (DVD MULTI IN):

This connection is the best connection method for enjoying DVD Audio sounds. When a DVD Audio disc is played back, the original high-quality sounds can be reproduced only using this connection.

Turn off all components before making connections.

- When you connect other components, refer also to their manuals.

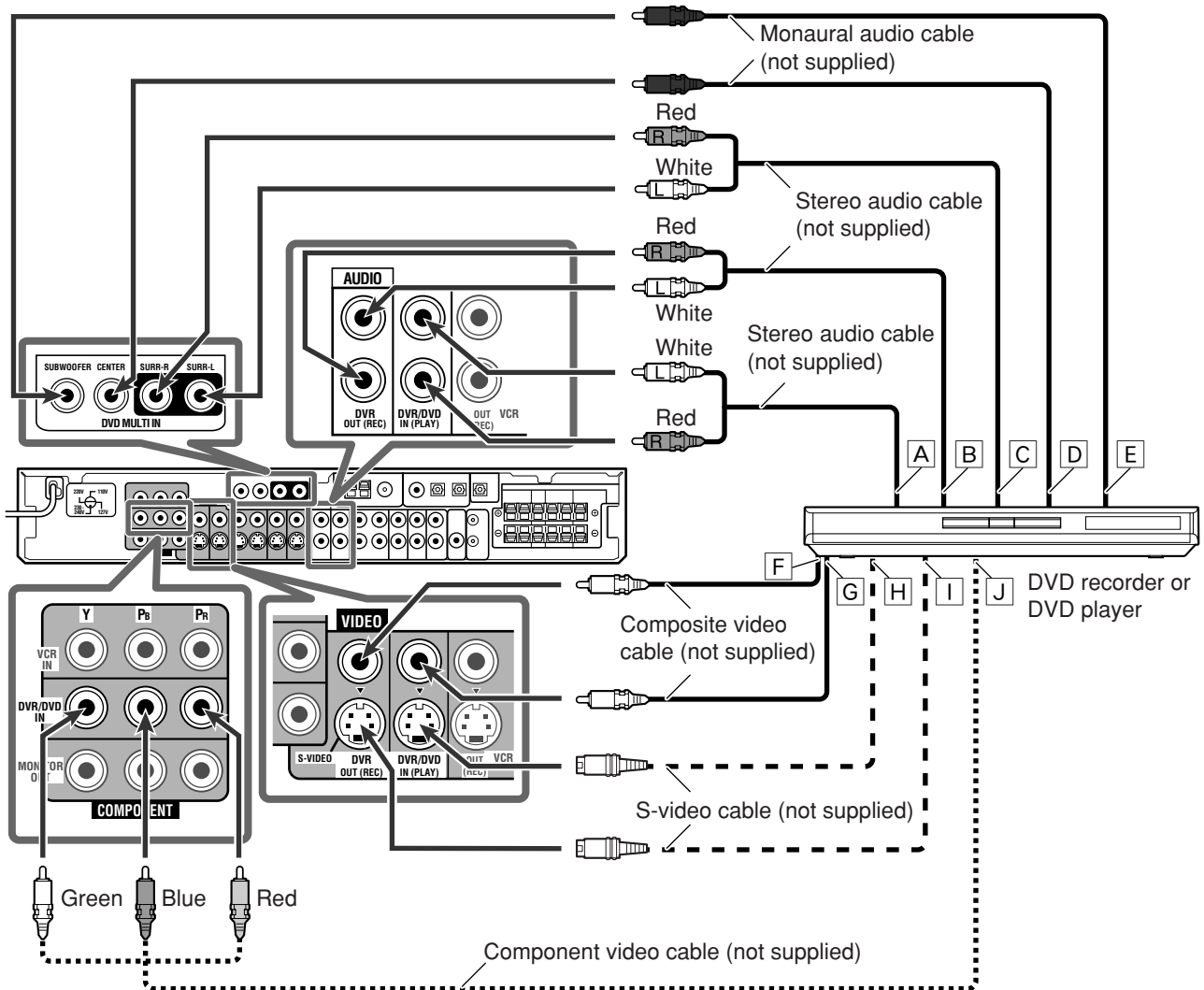

NOTE

When connecting a DVD recorder or DVD player to the component video input jacks, make the component video input setting (DVD VIDEO INPUT) correctly. If you do not, you cannot view the playback picture on the TV or the AV COMPU LINK remote control system cannot operate properly. For details, see page 25.

- A To left/right front channel audio output
- B **Only for DVD recorder:** To left/right front channel audio input
- C To left/right surround channel audio output
- D To center channel audio output
- E To subwoofer output
- F **Only for DVD recorder:** To composite video input
- G To composite video output
- H To S-video output
- I **Only for DVD recorder:** To S-video input
- J To component video output
 - Connect Y, P_B, and P_R correctly.

About "DVD MULTI"

When you select "DVD MULTI" as the source (see page 12), you can enjoy analog discrete output sound (5.1-channel reproduction) from the connected component.

- You may need to select analog discrete output mode on the component.

NOTES

- When using the headphones, you can listen to the front channel sounds (left and right) only. 3D HEADPHONE mode (see pages 36 and 37) is not available.
- When TV Direct is activated while "DVD MULTI" is selected as the source, the source changes to the last selected source—"DVR/DVD," "VCR," and "DBS" (see page 14).
- Surround/DSP modes (see pages 34 to 39) are not available for "DVD MULTI."

■ Connecting a VCR

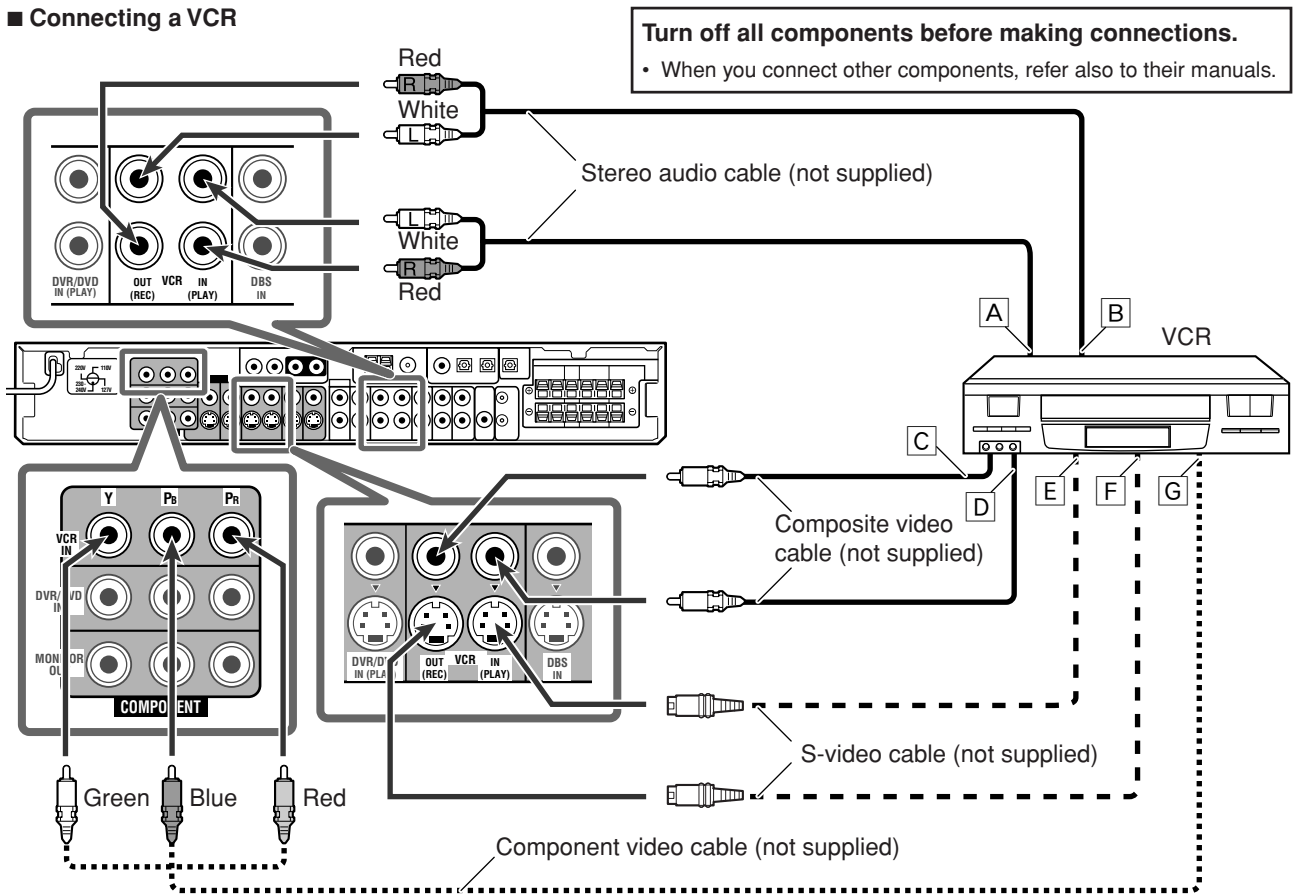

NOTES

- When connecting a VCR to the component video input jacks, make the component video input setting (VCR VIDEO INPUT) correctly. If you do not, you cannot view the playback picture on the TV or the AV COMPU LINK remote control system cannot operate properly. For details, see page 25.
- You can enjoy digital sound if using a digital coaxial or optical cable. When shipped from the factory, the audio input mode for a video component other than DVD recorder and DVD player is set to use the digital optical terminal (DIGITAL IN 3 (VCR)). For details of digital connection, see page 11.

- A** To left/right audio channel output
 - B** To left/right audio channel input
 - C** To composite video input
 - D** To composite video output
 - E** To S-video output
 - F** To S-video input
 - G** To component video output
- Connect Y, Pb, and Pr correctly.

■ Connecting a DBS tuner

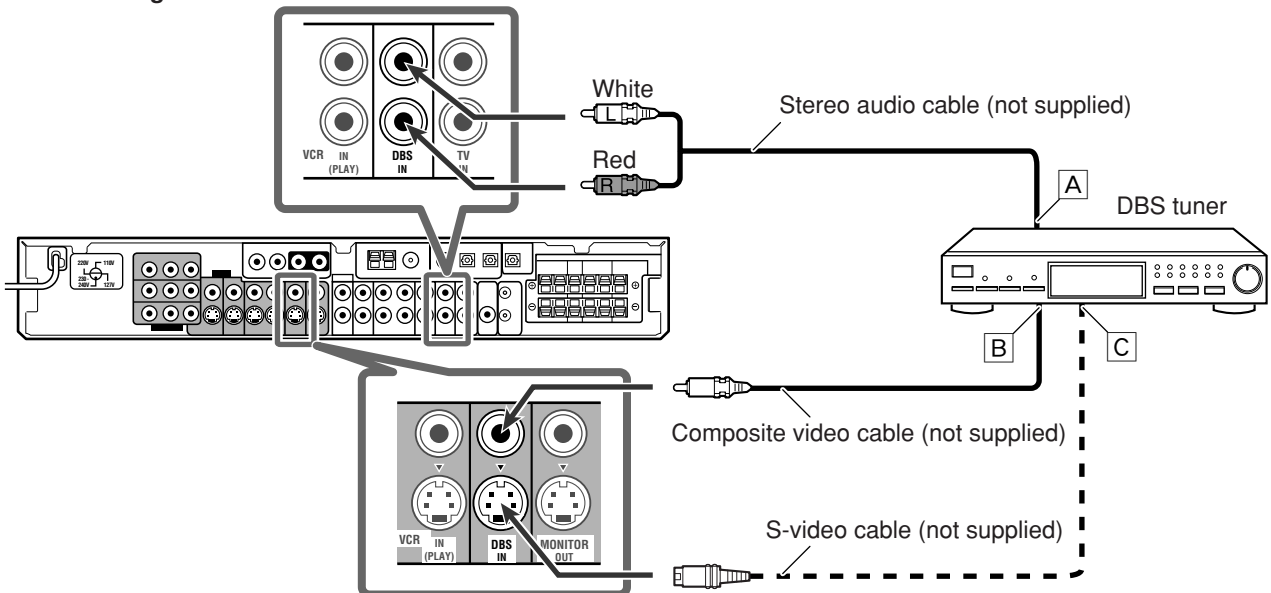

NOTE

You can enjoy digital sound if using a digital coaxial or optical cable. When shipped from the factory, the audio input mode for a TV is set to use the digital optical terminal (DIGITAL IN 2 (DBS)). For details of digital connection, see page 11.

- A** To left/right audio channel output
- B** To composite video output
- C** To S-video output

■ Connecting a TV

Connect the TV to the appropriate MONITOR OUT jacks to view the playback picture from any other connected video components.

Turn off all components before making connections.

- When you connect other components, refer also to their manuals.

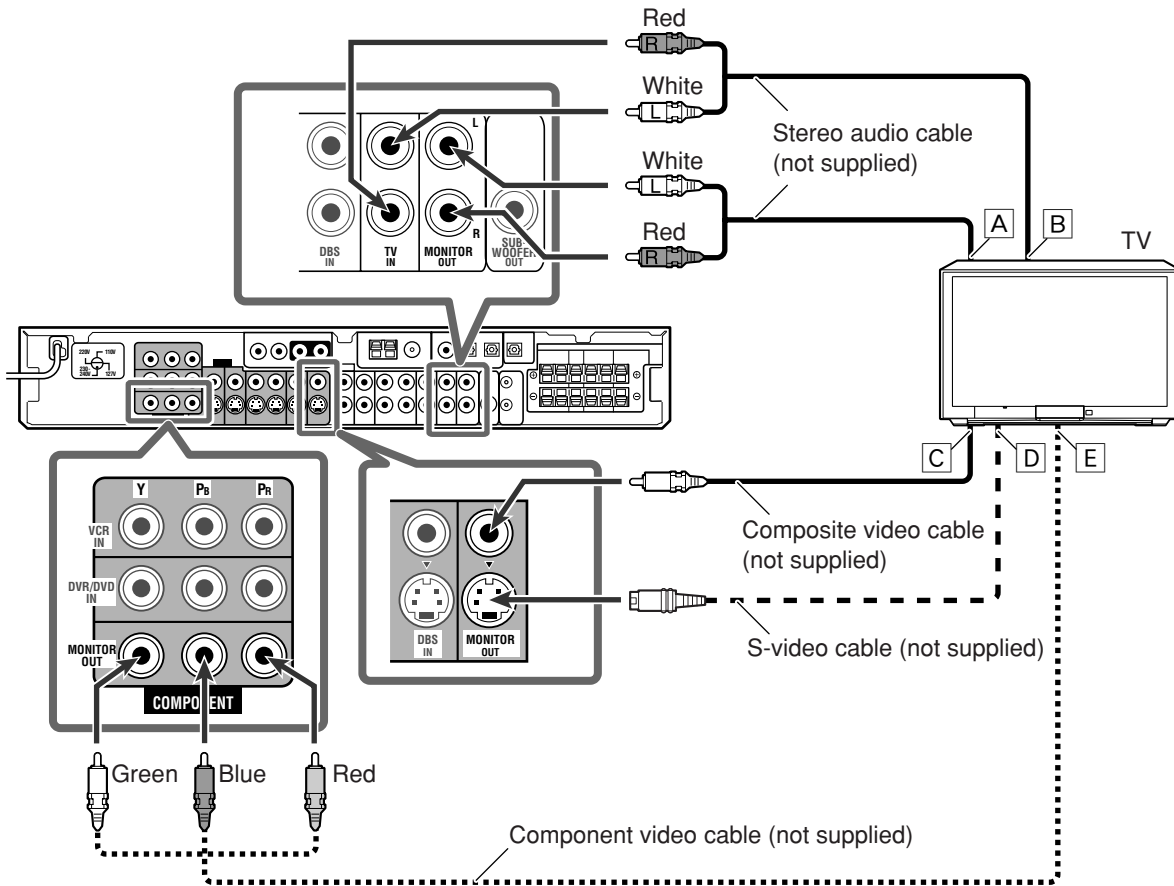

NOTES

- You can enjoy digital sound if using a digital coaxial or optical cable. For details of digital connection, see page 11.
- When connecting a TV through the COMPONENT MONITOR OUT jacks, the on-screen display does not appear on the TV screen (see page 25).

- A To left/right audio channel input
 - B To left/right audio channel output
 - C To composite video input
 - D To S-video input
 - E To component video input
- Connect Y, P_B, and P_R correctly.

IMPORTANT:

Audio signals come out through the MONITOR OUT (L/R) jacks ONLY when TV Direct is in use (see page 14). Connect these jacks to the audio input jacks corresponding to the video connection; otherwise, no sound comes out of the TV speaker when TV Direct is in use.

Digital connection

This receiver is equipped with three DIGITAL IN terminals—one digital coaxial terminal and two digital optical terminals—and one DIGITAL OUT terminal.

To reproduce the digital sound, use the digital connection in addition to the analog connection methods described on pages 7 to 10.

Digital coaxial cable (supplied: 1 cable)



Digital optical cable (not supplied)



Turn off all components before making connections.

- When you connect other components, refer also to their manuals.

Digital input terminals

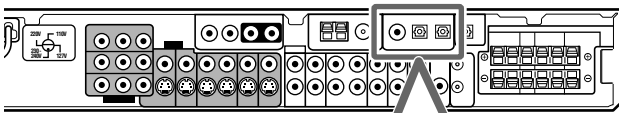

When the component has a digital coaxial output terminal, connect it to the 1(DVR/DVD) terminal, using a digital coaxial cable (supplied).

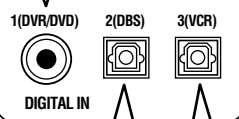

When the component has a digital optical output terminal, connect it to the 2(DBS) or 3(VCR) terminal, using a digital optical cable (not supplied).

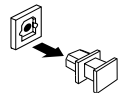

Before connecting a digital optical cable, unplug the protective plug.

NOTES

- When shipped from the factory, the DIGITAL IN terminals have been set for use with the following components:
 - 1(DVR/DVD): For DVD recorder or DVD player
 - 2(DBS): For DBS tuner
 - 3(VCR): For VCR

If you connect other components, change the digital input (DIGITAL IN) terminal setting correctly. See "Setting the digital input (DIGITAL IN) terminals—DIGITAL IN 1/2/3" on page 24.

- Select the digital input mode. See "Selecting the analog or digital input mode" on page 12.
- When you want to operate the connected component (except DBS tuner) using the AV COMPU LINK remote control system (see pages 40 and 41), connect them also as described on pages 7 to 10.

Digital output terminal

You can connect any digital components which have an optical digital input terminal.

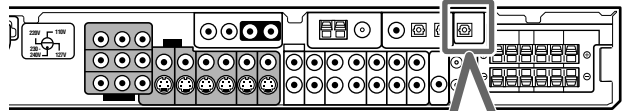

Connecting digital recording equipment to the DIGITAL OUT terminal enables you to perform digital-to-digital recording.

NOTE

The digital signal format transmitted through the DIGITAL OUT terminal is the same as that of the input signal. For example, when the DTS signals are input, the DTS signals are transmitted.

Connecting the power cord

When all the audio/video connections have been made, connect the AC power plug to the wall outlet. Make sure that the plugs are inserted firmly. The standby lamp lights in red.

CAUTIONS:

- Do not plug in before setting the VOLTAGE SELECTOR switch on the rear of the receiver and all connection procedures are complete.
- Do not touch the power cord with wet hands.
- Do not alter, twist or pull the power cord, or put anything heavy on it, which may cause fire, electric shock, or other accidents.
- If the cord is damaged, consult a dealer and have the power cord replaced with a new one.

NOTES

- Keep the power cord away from the connecting cables and the antenna. The power cord may cause noise or screen interference.
- The preset settings such as preset channels and sound adjustment may be erased in a few days in the following cases:
 - When you unplug the power cord.
 - When a power failure occurs.

Basic operations

The on-screen display appears on the TV screen for 5 seconds (except "turning off the sounds temporarily") to show the indication in the following cases:

- When you select the source (see right column).
- When you adjust the volume (see page 13).
- When you turn off the sounds temporarily (see page 15).
- When you select the Surround/DSP modes (see page 39).

To cancel the function, set "SUPERIMPOSE" to "SUPERIMPOSE: OFF" (see page 25).

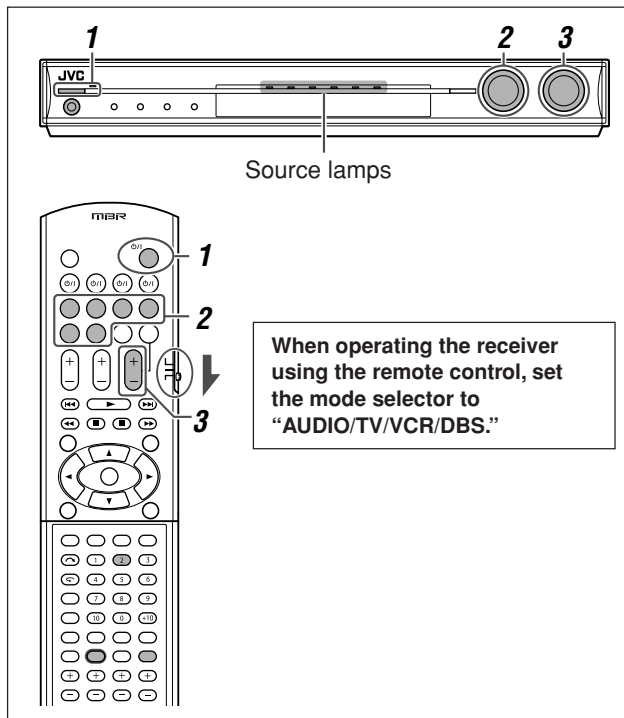

1 Turn on the power

Press **STANDBY/ON** (or **AUDIO** on the remote control).

The standby lamp goes off and the source lamp of the current source lights in red.

Current source name appears.

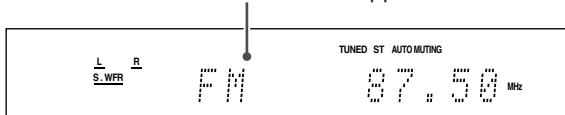

To turn off the power (into standby)

Press **STANDBY/ON** (or **AUDIO** on the remote control) again.

The standby lamp lights in red.

NOTE

A small amount of power is consumed in standby mode. To turn the power off completely, unplug the AC power cord.

2 Select the source to play

On the front panel:

Turn **SOURCE SELECTOR** until the source name you want appears on the display.

The source lamp corresponding to the selected source lights in red.

- As you turn **SOURCE SELECTOR**, the source changes as follows:

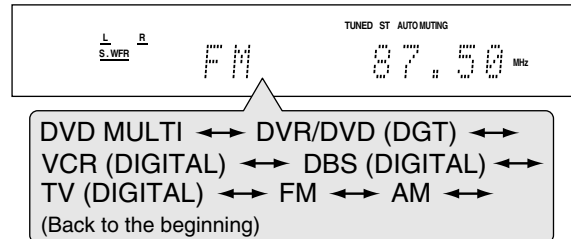

DVD MULTI:	Select for the DVD player using the analog discrete output mode (5.1-channel reproduction).
DVR/DVD (DGT)*:	Select for the DVD recorder or DVD player.
VCR (DIGITAL)*:	Select for the VCR.
DBS (DIGITAL)*:	Select for the DBS tuner.
TV (DIGITAL)*:	Select for the TV.
FM:	Select for an FM broadcast.
AM:	Select for an AM broadcast.

From the remote control:

Press one of the source selecting buttons.

- For the tuner, press **FM/AM**. Each time you press **FM/AM**, the band alternates between "FM" and "AM."

* Selecting the analog or digital input mode

For a component you have connected using both the analog connection and the digital connection methods (see pages 7 to 11), you need to select the correct input mode.

- You can select the digital input only for sources which you have selected digital input terminals for. (See "Setting the digital input (DIGITAL IN) terminals—DIGITAL IN 1/2/3" on page 24.)

From the remote control ONLY:

Press **ANALOG/DIGITAL INPUT** to select the analog or digital input mode.

- Each time you press the button, the input mode alternates between the analog input ("ANALOG") and the digital input ("DGTL AUTO").

This setting is memorized for each source.

DGTL AUTO: Select for the digital input mode. The receiver automatically detects the incoming signal format, then the digital signal format indicator (LPCM, DOLBY D, DTS, or DTS 96/24) for the detected signal lights up.

ANALOG: Select for the analog input mode.

Initial setting: DGTL AUTO

NOTE

When you select "DVD MULTI," "FM," or "AM" as the source, the analog and digital input mode is not available.

3 Adjust the volume

To increase the volume, turn **MASTER VOLUME** control clockwise (or press **VOLUME +** on the remote control).

To decrease the volume, turn **MASTER VOLUME** control counterclockwise (or press **VOLUME -** on the remote control).

- When you adjust the volume, the volume level indication appears on the display for a while.

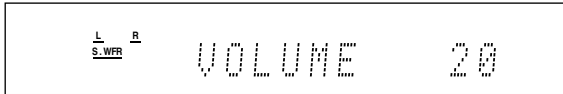

CAUTION:

Always set the volume to the minimum before starting any sources. If the volume is set at its high level, the sudden blast of sound energy can permanently damage your hearing and/or ruin your speakers.

NOTE

The volume level can be adjusted within the range of "0" (minimum) to "50" (maximum).

Listening with headphones

You can enjoy not only stereo software but also multi-channel software through the headphones. (Sounds are down-mixed to the front channels while playing multi-channel software.)

Connect a pair of headphones to the PHONES jack on the front panel to activate the HEADPHONE mode.

The HP (headphone) indicator lights up on the display.

- You can also enjoy the Surround/DSP mode through the headphones—3D HEADPHONE mode. For details, see pages 36 and 37.
- Disconnecting a pair of headphones from the PHONES jack cancels the HEADPHONE (or 3D HEADPHONE) mode and activates the speakers.

CAUTION:

Be sure to turn down the volume:

- Before connecting or putting on headphones, as high volume can damage both the headphones and your hearing.
- Before removing headphones, as high volume may output from the speakers.

Selecting the digital decode mode

If the following symptoms occur while playing Dolby Digital or DTS software with "DGTL AUTO" selected (see page 12), follow the procedure below:

- Sound does not come out at the beginning of playback.
- Noise comes out while searching for or skipping chapters or tracks.

From the remote control ONLY:

Press SOUND, then press DECODE to select "DOLBY D" or "DTS."

- Each time you press DECODE, the digital decode mode changes as follows:

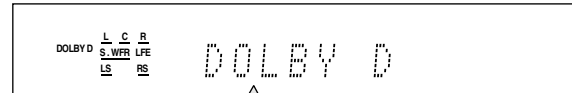

DGTL AUTO → DOLBY D →
DTS → (Back to the beginning)

- To play back software encoded with Dolby Digital, select "DOLBY D."
- To play back software encoded with DTS, select "DTS."

NOTES

- When you turn off the power or select another source, "DOLBY D" or "DTS" is canceled and the digital decode mode is automatically reset to "DGTL AUTO."
- After pressing SOUND, the numeric buttons work for sound adjustments. To use the numeric buttons to operate your target source, press the corresponding source selecting button before operation; otherwise, the remote control may not work as you intend.

The following digital signal format indicators on the display indicate what type of signal comes into the receiver.

LPCM: Lights up when Linear PCM signal comes in.

DOLBY D:

- Lights up when Dolby Digital signal comes in.
- Flashes when "DOLBY D" is selected for any software other than Dolby Digital.

DTS:

- Lights up when conventional DTS signal comes in.
- Flashes when "DTS" is selected for any software other than DTS.

DTS 96/24: Lights up when DTS 96/24 signal comes in.

NOTE

When "DGTL AUTO" cannot recognize the incoming signal, no digital signal format indicator lights up on the display.

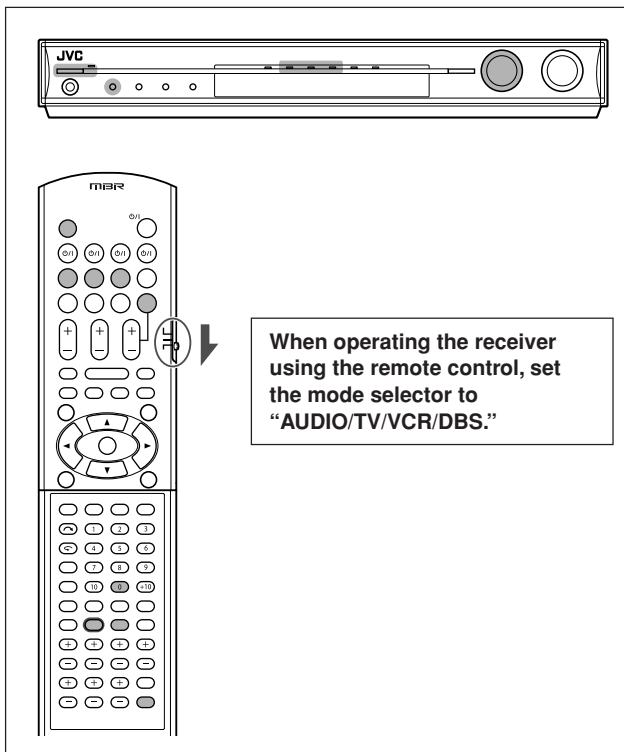

Adjusting the subwoofer audio position

If the subwoofer sound is much reinforced for stereo sound compared to the sound reproduced with multi-channel, set the subwoofer audio position. The subwoofer output level is automatically decreased by the selected value when you are listening in stereo.

The AUDIO P. indicator lights up when this function is activated.

- Once you have made an adjustment, it is memorized for each source.

From the remote control ONLY:

Press SOUND, then press A.POSITION repeatedly.

- Each time you press A.POSITION, the subwoofer audio position level changes as follows:

AUDIO P. indicator

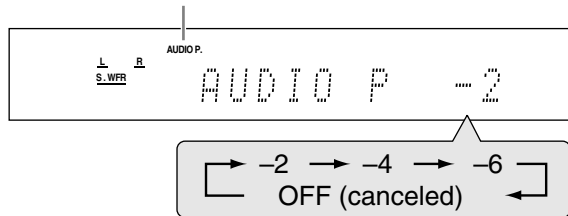

The smaller the number becomes, the more the level decreases automatically when listening in stereo.

- If no adjustment is required, select "OFF" (initial setting).

NOTES

- The minimum subwoofer output level is -10 dB.
Ex.: When setting the subwoofer output level to " -8 (dB)" and the subwoofer audio position to " -4 (dB)," the subwoofer output level when listening in stereo will be -10 dB.
To adjust the subwoofer output level, see page 29.
- This function is not available when the Surround/DSP mode is activated or "DVD MULTI" is selected.
- After pressing SOUND, the numeric buttons work for sound adjustments. To use the numeric buttons to operate your target source, press the corresponding source selecting button before operation; otherwise, the remote control may not work as you intend.

Activating TV Direct

TV Direct enables you to use this receiver as an AV selector **while the receiver is turned off**.

When TV Direct is activated, the pictures and sounds go from the video components such as DVD player to the TV through this receiver. Thus, you can use the video components and the TV as if they were connected directly.

- This function takes effect for the following sources—DVR/DVD, VCR, and DBS.

To activate (or deactivate) TV Direct, follow the procedure below:

1 Press TV DIRECT.

All the indications disappear, then the source lamp of the current source lights in green.

2 Turn on the video component and TV.

3 Select the target video component.

On the front panel:

Turn SOURCE SELECTOR until one of the source lamps—DVR/DVD, VCR, or DBS—lights in green.

From the remote control:

Press one of the source selecting buttons—DVR/DVD, VCR, or DBS.

The source lamp corresponding to the selected source lights in green.

To cancel TV Direct and turn off the receiver, press \odot /I STANDBY/ON on the front panel (or \odot /I AUDIO on the remote control).

The receiver is turned off and the standby lamp lights up.

To cancel TV Direct and turn on the receiver, press TV DIRECT again.

The receiver is turned on and the source lamp currently selected lights in red.

NOTES

- When TV Direct is activated, you cannot enjoy any of the sound effects the receiver produces, and cannot use the speakers connected to the receiver.
- When TV Direct is activated while "DVD MULTI," "FM," or "AM" is selected as the source, the source changes to the last selected source—"DVR/DVD," "VCR," or "DBS."

Turning off the sounds temporarily

From the remote control ONLY:

Press MUTING to turn off the sound through all connected speakers and headphones.

"MUTING" appears on the display and the volume turns off.



To restore the sound, press MUTING again.

- Pressing VOLUME +/- (or turning MASTER VOLUME control on the front panel) also restores the sound.

Changing the display brightness

You can dim the display—Dimmer.

From the remote control ONLY:

Press DIMMER repeatedly.

- Each time you press the button, the display brightness changes as follows:

- DIMMER 1: Dims the display slightly.
Dims the blue illumination slightly.
- DIMMER 2: Dims the display more than DIMMER 1.
Dims the blue illumination slightly (more than DIMMER 1).
- DIMMER 3: Turns off the display and blue illumination.
(Temporarily canceled when you operate the receiver.*)
- DIMMER OFF: Cancels the Dimmer (normal display).

* Except when activating or deactivating TV Direct.

Turning off the power with the Sleep Timer

You can fall asleep while listening to music—Sleep Timer.

From the remote control ONLY:

Press SLEEP repeatedly.

- Each time you press the button, the shut-off time changes in 10 minute intervals. The SLEEP indicator lights up on the display.

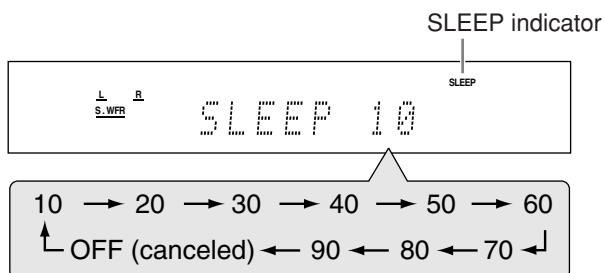

When the shut-off time comes:

The receiver turns off automatically.

To check or change the remaining time until the shut-off time:

Press SLEEP once.

The remaining time (in minutes) until the shut-off time appears.

- To change the shut-off time, press SLEEP repeatedly.

To cancel the Sleep Timer:

Press SLEEP repeatedly so that "SLEEP OFF" appears on the display. (The SLEEP indicator goes off.)

- The Sleep Timer is also canceled when:
 - You turn off the receiver, or
 - TV Direct is activated.

Basic adjustment of auto memory

This receiver memorizes sound settings for each source:

- when you turn off the power, and
- when you change the source.

When you change the source, the memorized settings for the newly selected source are automatically recalled.

The following can be stored for each source:

- Analog/digital input mode (see page 12)
- Subwoofer audio position (see page 14)
- Midnight mode (see page 24)
- Speaker output level (see page 29)
- Digital equalization pattern (see page 30)
- Bass boost (see page 30)
- Subwoofer phase (see page 30)
- Input attenuator mode (see page 30)
- Surround/DSP mode selection (see page 39)

NOTE

If the source is "FM" or "AM," you can assign a different setting for each band.

Signal and speaker indicators on the display

Signal indicators

Speaker indicators

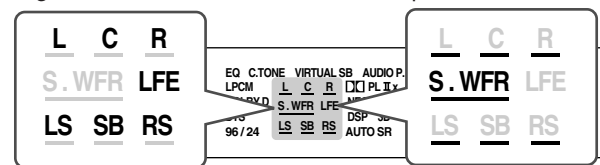

The signal indicators light up as follows:

- L:
 - **When digital input is selected:** Lights up when the left channel signal comes in.
 - **When analog input is selected:** Always lights up.
- R:
 - **When digital input is selected:** Lights up when the right channel signal comes in.
 - **When analog input is selected:** Always lights up.
- C: Lights up when the center channel signal comes in.
- LS*: Lights up when the left surround channel signal comes in.
- RS*: Lights up when the right surround channel signal comes in.
- SB: Lights up when the surround back channel signal comes in.
- LFE: Lights up when the LFE channel signal comes in.

* When monaural surround signal comes in, only "S" lights up.

NOTE

When "DVD MULTI" is selected as the source, all the signal indicators except "SB" light up.

The speaker indicators light up as follows:

- The subwoofer indicator (**S.WFR**) lights up when "SUBWOOFER" is set to "SUBWOOFER: YES." For details, see page 21.
- The other speaker indicators light up only when the corresponding speaker is set to "SMALL" or "LARGE," and also when required for the current playback.

Basic settings

To obtain the best possible sound effect from Surround/DSP modes (see pages 34 to 39), you need to set up the speaker and subwoofer information after all the connections are completed. From pages 16 to 25, how to set speakers and other basic items of the receiver are explained.

Setting the speaker information automatically—Smart Surround Setup

The distance from your listening point to the speakers is one of the important elements to obtain the best possible sound effect from the Surround/DSP modes.

By using Smart Surround Setup, the following are automatically calculated by one simple action—clapping hands.

- Speaker distance (compared to that of the closest speaker)
- Speaker output level (except the subwoofer)

NOTES

- Before starting Smart Surround Setup, set the speaker information correctly (SMALL, LARGE, or NO) according to your speakers except the subwoofer (see page 21).
- The speakers which are set to “NO” in the speaker setting (see page 21) are not indicated clearly on the TV screen.
- When the setting is made by Smart Surround Setup, the speaker distance and output level you have set before will be inactive.
- You can see the setting process on the TV screen and the display during Smart Surround Setup. If you have turned off the display, cancel the Dimmer (see page 15); otherwise, you cannot see the information on the display.
- Smart Surround Setup will not be done correctly if you or other object blocks the sound.
- When you change your speakers, do the following procedure again.

In this section, the on-screen display on the TV screen is used for explaining.

- The on-screen display does not appear on the TV screen when connecting the TV through the COMPONENT MONITOR OUT jacks (see page 10).

From the remote control ONLY:

When operating the receiver using the remote control, set the mode selector to “AUDIO/TV/VCR/DBS.”

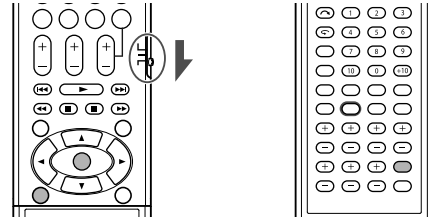

1 Take your position where you listen to the sound.

- Make sure speaker cables are connected firmly.

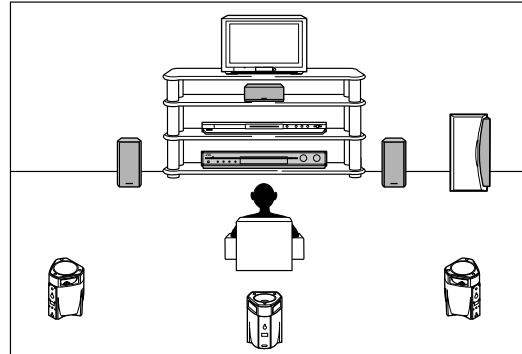

2 Press and hold SMART SURROUND SETUP until “SETTING UP” flashes.

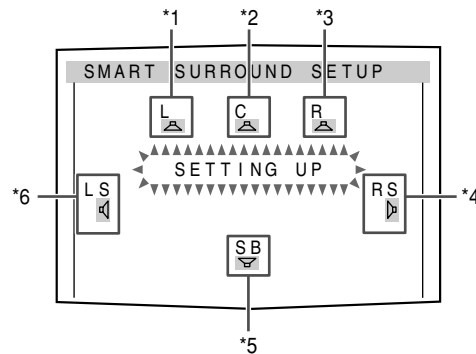

- *1 L: Left front speaker
- *2 C: Center speaker
- *3 R: Right front speaker
- *4 RS: Right surround speaker
- *5 SB: Surround back speaker
- *6 LS: Left surround speaker

3 When “CLAP YOUR HANDS.” appears, clap your hands over your head once while the indications still remain.

- On the display, “SETTING UP” stops flashing.

The receiver starts detecting the level of the sound coming through each speaker (except the subwoofer).

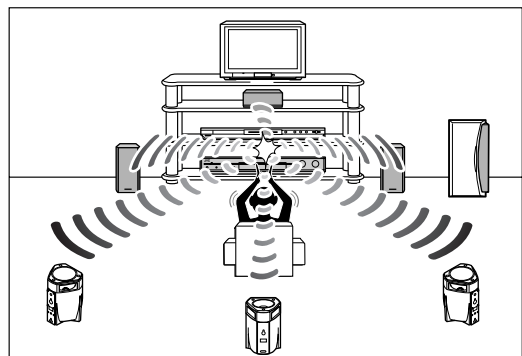

When your clapping sound is detected successfully

- On the TV screen, "SUCCESSFUL," "RESULT," and the setting values appear. The setting values are shown for about 12 seconds.

Ex.:

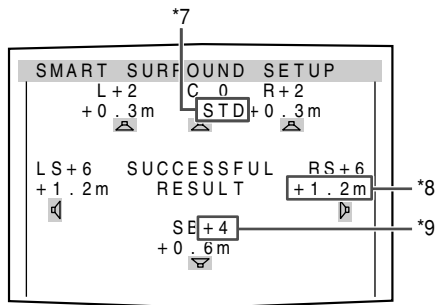

- On the display, "SUCCESSFUL" appears, then the setting values are shown as follows for about 12 seconds:

Ex.:

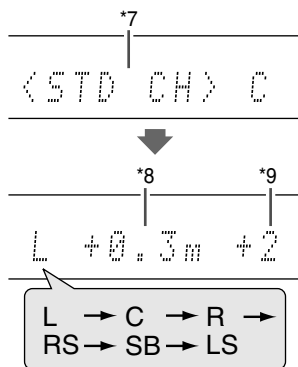

- *7 Standard channel (the closest speaker). This speaker position now works as the reference position ("0m/ft") and other speakers' distance is shown by the difference with this reference speaker position.
- *8 Difference of each speaker position in distance (in meters or feet).
- *9 Each speaker's output level (-6 to +6).

When finishing displaying the setting values

On the TV screen, "COMPLETED" appears, then "TEST TONE" and "END" appear. On the display, "TEST? END?" appears.

- To adjust the speakers' output levels manually, press TEST TONE (see page 29).
- To erase the on-screen display, press SET or any button except TEST TONE.
- The receiver returns to normal operation mode automatically if no operations are done for about 10 seconds.

Ex.:

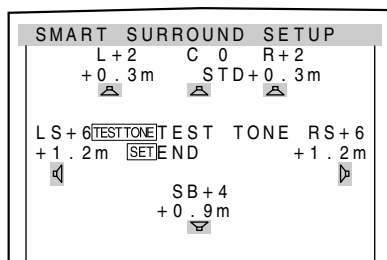

When your clapping sound is not detected correctly

"SETTING UP" appears again after one of the following messages. In this case, repeat step 3.

- SILENT:**
 - The receiver detects sound from only the left and right front speakers.
 - The receiver detects no sound from the front speakers and detects sound from at least one of the other speakers.
- SILENT-ALL:** The receiver cannot detect any sound from any speaker for about 10 seconds.
- AGAIN:**
 - The receiver cannot detect sound from the left or right front speaker.
 - The receiver fails to calculate the speakers' output level and difference of each speaker's position in distance.

In the following cases, set the speakers manually.

• When "SILENT" appears twice in succession

The setting is partially made. (The distance of the speakers from which sound has not been detected is set to "+9.0m (+30ft).")

The receiver exits from Smart Surround Setup.

• When "MANUAL" appears

The receiver fails to detect the sound three times. The receiver exits from Smart Surround Setup.

To cancel Smart Surround Setup, press SMART SURROUND SETUP while "SETTING UP" flashes.

- No other operations can be accepted after "SETTING UP" stops flashing. Complete the Smart Surround Setup.

To check the current setting made by Smart Surround Setup,

press SMART SURROUND SETUP while the receiver is in normal operation mode.

The setting values appear. On the display, the setting values are shown one after another.

- The current setting is not indicated but "MANUAL" appears if you change the following settings after using Smart Surround Setup:
 - If you change speaker distance manually.
 - If you change one of the speaker sizes either from "NO" to "SMALL" or "LARGE," or from "SMALL" or "LARGE" to "NO."
 To check the current setting, see each setting item of the speaker distance (see page 22) and the speaker output level (see page 29).
- If you have not used Smart Surround Setup, "NO S.S.S." appears.

NOTES

- The speaker distance and output level manually set will be applied instead of those set by using Smart Surround Setup in the following cases:
 - When you change one of the speaker distance (see page 22).
 - When you change one of the speaker size either from "NO" to "SMALL" or "LARGE," or from "SMALL" or "LARGE" to "NO" (see page 21).
- When you want to adjust the speaker distance and output level manually, see pages 22 and 29.
- When the headphone is in use or "DVD MULTI" is selected as the source, the receiver returns to normal operation mode without showing "TEST TONE."
- Do not clap your hands so hard that it may hurt your hands.

Basic setting items

You can adjust the following items. See pages in parentheses for details.

- You cannot select the items which is not available with the current setting.
- The name of the item shown below is the on-screen display indication and the name in parentheses is the display indication.

Items and to do	
SUBWOOFER (SUBWOOFER) Register your subwoofer. (21)	DUAL MONO (DUAL MONO) Select the Dual Mono sound channel. (23)
FRONT SPK (FRONT SPK) Register your front speaker size. (21)	SUBWFR OUT (SUBWFR OUT) Select sounds emitted from the subwoofer. (23)
CENTER SPK (CENTER SPK) Register your center speaker size. (21)	CROSSOVER (CROSSOVER) Select the cutoff frequency to the subwoofer. (23)
SURR. SPK (SURRND SPK) Register your surround speaker size. (21)	LFE ATT (LFE ATT) Attenuate the bass (LFE) sounds. (23)
SURR. BACK SPK (S BACK SPK) Register your surround back speaker size. (21)	MIDNIGHT (MIDNIGHT) Reproduce a powerful sound at night. (24)
DISTANCE UNIT (DIST UNIT) Select the measuring unit for the speaker distance. (22)	DIGITAL IN 1 (DIGITAL IN1) Select the component connected to the digital coaxial terminal—1(DVR/DVD). (24)
FL SPK DISTANCE (FRNT L DIST)* Register the distance from the left front speaker to your listening point. (22)	DIGITAL IN 2 (DIGITAL IN2) Select the component connected to the digital optical terminal—2(DBS). (24)
FR SPK DISTANCE (FRNT R DIST)* Register the distance from the right front speaker to your listening point. (22)	DIGITAL IN 3 (DIGITAL IN3) Select the component connected to the digital optical terminal—3(VCR). (24)
C SPK DISTANCE (CENTER DIST)* Register the distance from the center speaker to your listening point. (22)	DVD VIDEO (DVD VIDEO) Select the type of video terminal used for the DVD recorder or DVD player. (25)
LS SPK DISTANCE (SURR L DIST)* Register the distance from the left surround speaker to your listening point. (22)	VCR VIDEO (VCR VIDEO) Select the type of video terminal used for the VCR. (25)
RS SPK DISTANCE (SURR R DIST)* Register the distance from the right surround speaker to your listening point. (22)	SUPERIMPOSE (SUPERIMPOSE) Select to superimpose the menus on the TV screen. (25)
SB SPK DISTANCE (S BACK DIST)* Register the distance from the surround back speaker to your listening point. (22)	DOWN MIX (DOWN MIX) Select to convert S-video signals into composite video signals. (25)
EX/ES/PLIIX (EX/ES/PLIIX) Select the EX/ES/PLIIX reproduction mode. (22)	Y/C SEPARATE (Y/C SEP.) Select to convert composite video signals into S-video signals. (25)

* If you have used Smart Surround Setup on pages 16 and 17, these settings are not required.

Operation through on-screen display menus

You can make adjustments to the basic settings easily by using the on-screen display menus.

Menu operation buttons

On the front panel:



Button / JOG	To do
SETTING button	show setting item previously selected.
SET button	move to the selected menu or return to the previous SETTING MENU.
MULTI JOG	<ul style="list-style-type: none"> • select a menu or an item. • change a setting.

From the remote control:

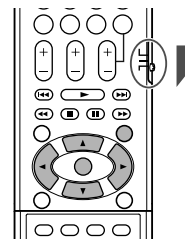

When operating the receiver using the remote control, set the mode selector to "AUDIO/TV/VCR/DBS."

Button	To do
MENU button	show "TOP MENU."
▲ / ▼ buttons	select a menu or an item.
SET button	move to the selected menu or return to the previous SETTING MENU.
◀ / ▶ buttons	change a setting.

Setup menu configuration

- Items on the menus shown below are all set to the initial values when shipping from the factory.
- Some of the menus or some items on the menu cannot be shown or cannot be adjusted depending on the current settings and the connections. (For details, see the respective explanations in this section.)

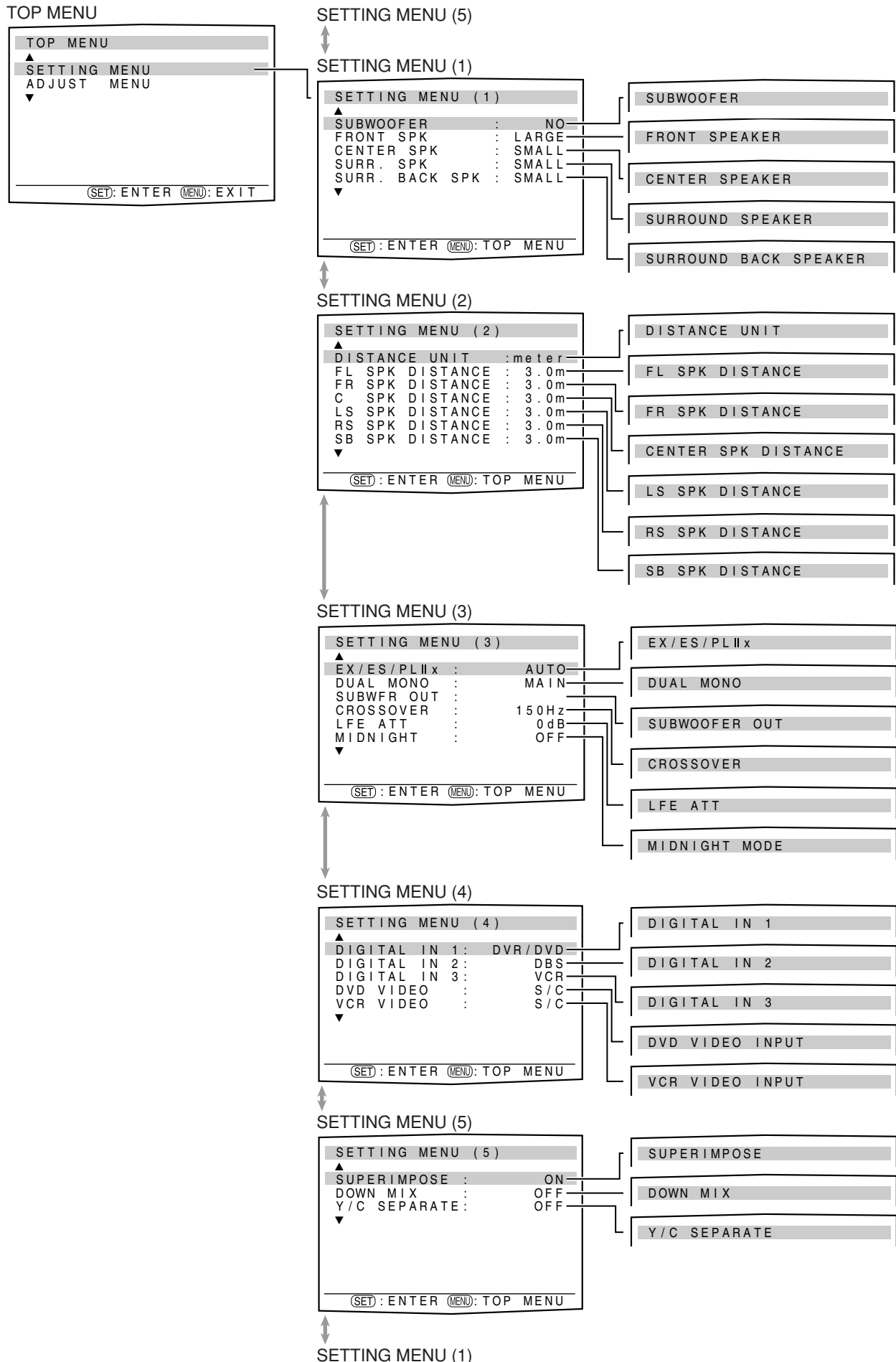

Menu operating procedure

When operating, the on-screen display appears on the TV screen regardless of the SUPERIMPOSE setting (see page 25).

Before you start, remember...

There is a time limit in doing the following steps. If the setting is canceled before you finish, start from step **1** again.

In this section, the operation of the remote control is used for explaining.

Ex.: When setting DIGITAL IN 1 terminal.

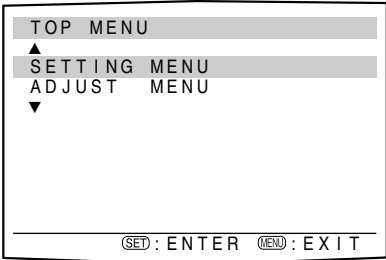
Operations	On the TV screen	On the display
<p>1 To show “TOP MENU,” press MENU.</p>	 <p>“TOP MENU” appears.</p>	<div style="border: 1px solid black; padding: 5px; width: fit-content; margin: 0 auto;">SETTING</div> <p>“SETTING” appears.</p>

2 To select “SETTING MENU,” press SET.

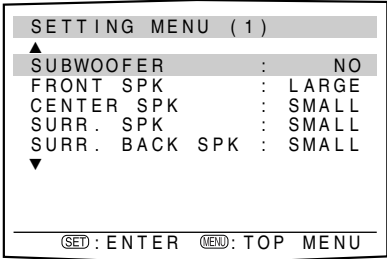
 <p>The setting item previously selected appears.</p>	<div style="border: 1px solid black; padding: 5px; width: fit-content; margin: 0 auto;">SUBWOOFER</div> <p>The submenu previously selected appears.</p>
--	---

3 To select the desired submenu, press ▲ or ▼ repeatedly.

There are five screens from “SETTING MENU (1)” to “SETTING MENU (5).” To change the screen, simply pressing ▲ or ▼ repeatedly. You can go to the next/previous screen.

- On the front panel, turn MULTI JOG.

Button indications on the screen

The buttons for operating the menu are shown on the TV screen. You can operate the menu with these buttons.

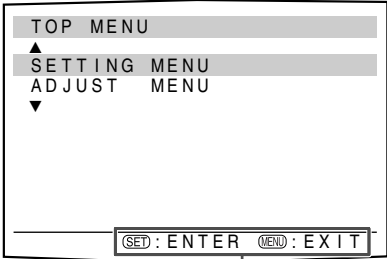
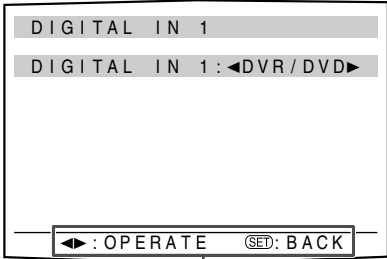
 <p>Usable buttons and their functions</p>	 <p>Usable buttons and their functions</p>
---	--

4 Press SET.

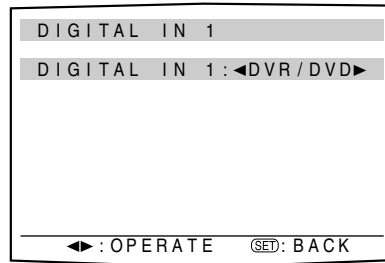

D1 DVR/DVD

The current setting of the selected item appears.

The selected submenu appears.

5 To select the appropriate setting, press ◀ or ▶ repeatedly, then press SET.

The on-screen display returns to the previous SETTING MENU. In this example, "SETTING MENU (4)" appears on the TV screen and "DIGITAL IN1" appears on the display.

- On the front panel, turn MULTI JOG, then press SET.

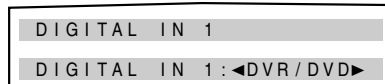

D1 DVR/DVD

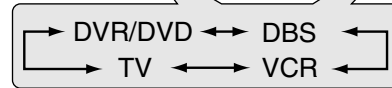

6 Repeat steps 2 to 5 to set other items if necessary.

NOTES

- To return to "TOP MENU," press MENU on the remote control.
- To exit from menu operations, press MENU on the remote control when "TOP MENU" appears. On the front panel, press SETTING when a menu except "TOP MENU" appears.
- The setting item previously selected can be shown on the TV screen by pressing SETTING on the front panel when the receiver is in normal operation mode.

Setting the items

When performing the basic settings viewing the indications on the display, the indications are slightly different from what is shown on the on-screen display.

This is because of the limited number of characters shown on the display.

Ex.: • "SUBWOOFER: YES" is shown as "SUBWFR: YES" on the display.

- "MIDNIGHT MODE: OFF" is shown as "NIGHT: OFF" on the display.

Setting the speakers

■ Setting subwoofer information—SUBWOOFER

Each time the receiver turns on, the receiver detects the subwoofer connection and automatically changes the setting of the subwoofer.

When you want to change the setting manually, select either one below.

SUBWOOFER: YES

Select when you have connected a subwoofer.

The subwoofer indicator (**S.WFR**) lights up on the display. You can adjust the subwoofer output level (see page 29).

SUBWOOFER: NO

Select when you have disconnected a subwoofer. Selecting this changes the front speaker size to "LARGE" (see right column).

NOTE

You need to change the setting each time you turn on the receiver if you want to change the subwoofer information set automatically.

■ Setting the speaker size—FRONT SPEAKER, CENTER SPEAKER, SURROUND SPEAKER, SURROUND BACK SPEAKER

Register the sizes of all the connected speakers.

LARGE	Select when the cone speaker size is larger than 12 cm.
SMALL	Select when the cone speaker size is smaller than 12 cm.
NO	Select when you have disconnected a speaker. (Not selectable for the front speakers.)

Initial setting: SMALL for all speakers*

* When "SUBWOOFER" is set to "SUBWOOFER: NO," the front speaker size is fixed to "LARGE" (and you cannot select "SMALL").

NOTES

- If you have selected "SMALL" for the front speaker size, you cannot select "LARGE" for other speakers.
- When "SURROUND SPEAKER" is set to "SURROUND SPK: SMALL," you cannot select "LARGE" for the surround back speaker.
- When "SURROUND SPEAKER" is set to "SURROUND SPK: NO," the surround back speaker is fixed to "NO."
- If you change one of the speaker sizes either from "NO" to "SMALL" or "LARGE," or from "SMALL" or "LARGE" to "NO," the distance manually set will be applied instead of those set by using Smart Surround Setup.

■ Setting the speaker distance

The distance from your listening point to the speakers is one of the important elements to obtain the best possible sound effect from the Surround/DSP modes.

By referring to the speaker distance, the receiver automatically sets the delay time of the sound through each speaker so that sounds through all the speakers can reach you at the same time.

- If you have used Smart Surround Setup on pages 16 and 17, this setting is not required.

■ Measuring unit—DISTANCE UNIT

Select which measuring unit you use.

DISTANCE UNIT: meter Select to set the distance in meters.

DISTANCE UNIT: feet Select to set the distance in feet.

Initial setting: DISTANCE UNIT: meter

■ Speaker distance—

**FL SPK DISTANCE (for the left front speaker),
FR SPK DISTANCE (for the right front speaker),
CENTER SPK DISTANCE (for the center speaker),
LS SPK DISTANCE (for the left surround speaker),
RS SPK DISTANCE (for the right surround speaker),
SB SPK DISTANCE (for the surround back speaker)**

Adjustable range: 0.3 m to 9.0 m in 0.3 m intervals
(1 ft to 30 ft in 1 ft intervals)

Initial setting: 3.0 m (10 ft) for all speakers

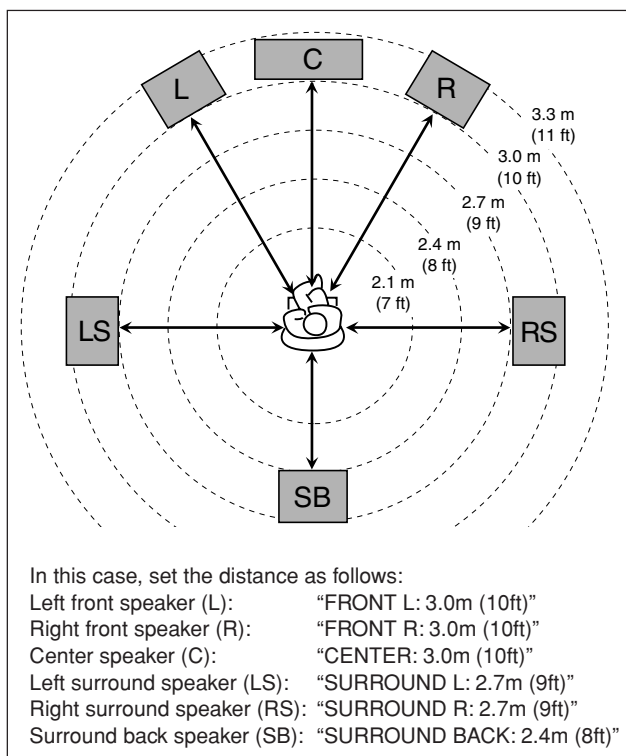

NOTES

- You cannot set the speaker distance for the speakers you have set to "NO."
- If you change one of these settings manually, the distance manually set will be applied instead of those set by using Smart Surround Setup.

Activating the EX/ES/PLIIX setting —EX/ES/PLIIX

Depending on this setting, available Surround modes for digital multi-channel software vary—EX/ES/PLIIX (6.1-channel) reproduction or 5.1-channel reproduction. Select an appropriate setting for your enjoyment.

- For details about relation between EX/ES/PLIIX setting and available Surround mode, see page 38.
- To activate the Surround mode, see page 39.

EX/ES/PLIIX: AUTO

According to the incoming signal, an appropriate Surround mode is applied.

- For Dolby Digital Surround EX and DTS-ES software, 6.1-channel reproduction is applied*.
- For other multi-channel (more than 4 channel) encoded software, 5.1-channel reproduction is applied.

EX/ES/PLIIX: ON

Select to apply 6.1-channel reproduction to both 5.1-channel and 6.1-channel encoded software.

EX/ES/PLIIX: PLIIX MOVIE

Select to apply "PLIIX MOVIE" (6.1-channel) reproduction to both 5.1-channel and 6.1-channel encoded software.

EX/ES/PLIIX: PLIIX MUSIC

Select to apply "PLIIX MUSIC" (6.1-channel) reproduction to both 5.1-channel and 6.1-channel encoded software.

EX/ES/PLIIX: OFF

Select to cancel the EX/ES/PLIIX (6.1-channel) reproduction.

Initial setting: EX/ES/PLIIX: AUTO

- * For some Dolby Digital Surround EX software, Dolby Digital 5.1-channel reproduction ("DOLBY D") may be applied even though you have selected "EX/ES/PLIIX: AUTO." In this case, select "EX/ES/PLIIX: ON" to apply "DOLBY D EX."

From the remote control

You can also make adjustments the following way from the remote control.

Set the mode selector to "AUDIO/TV/VCR/DBS."

Press EX/ES repeatedly to select an appropriate setting for your enjoyment.

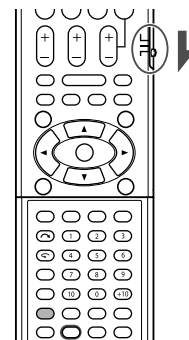

NOTES

- This function is not available in the following cases:
 - When "SURROUND SPEAKER" is set to "SURROUND SPK: NO" (see page 21).
 - When "DVD MULTI" is selected as the source.
- When "SURROUND BACK SPEAKER" is set to "SURR. BACK SPK: NO" (see page 21), the Virtual Surround Back (see page 38) is applied to EX/ES/PLIIX (6.1-channel) reproduction.

Selecting the main or sub channel —DUAL MONO

You can select the playback sound (channel) you want while playing digital software recorded (or broadcasted) in Dual Mono mode (see page 36), which includes two monaural channels separately.

DUAL MONO: MAIN

Select to play back the main channel (Ch 1).*
Signal indicator “L” lights up while playing back this channel.

DUAL MONO: SUB

Select to play back the sub-channel (Ch 2).*
Signal indicator “R” lights up while playing back this channel.

DUAL MONO: ALL

Select to play back both the main and sub-channels (Ch 1/Ch 2).*
Signal indicators “L” and “R” light up while playing back these channels.

Initial setting: DUAL MONO: MAIN

* Dual Mono signals can be heard from the following speakers—L (left front speaker), R (right front speaker), and C (center speaker), with respect to the current Surround setting:

Dual Mono setting	Without Surround		With Surround Activated				
			Center speaker setting				
			SMALL/LARGE			NO	
L	R	L	C	R	L	R	
MAIN	Ch 1	Ch 1	—	Ch 1	—	Ch 1	Ch 1
SUB	Ch 2	Ch 2	—	Ch 2	—	Ch 2	Ch 2
ALL	Ch 1	Ch 2	—	Ch 1+Ch 2	—	Ch 1+Ch 2	Ch 1+Ch 2

NOTE

The Dual Mono format is not identical with bilingual broadcasting for TV programs. So this setting does not take effect while watching such bilingual programs.

Setting bass sound

■ Setting subwoofer output—SUBWOOFER OUT

You can select the type of the signal which can be transmitted through the subwoofer. In other words, you can determine whether or not the bass elements of the front speaker channels are transmitted through the subwoofer regardless of the front speaker size setting (either “SMALL” or “LARGE”).

SUBWFR OUT: LFE

Select to emit only the LFE signals (while playing Dolby Digital and DTS software) or the bass elements of the “SMALL” front speakers (while playing any source other than above).

SUBWFR OUT: LFE+MAIN

Select to always emit the bass elements of the front speaker channels (MAIN). While playing Dolby Digital and DTS software, the bass elements and the LFE signals are both emitted.

Initial setting: SUBWFR OUT: LFE

NOTE

When “SUBWOOFER” is set to “SUBWOOFER: NO” (see page 21), this function is not available.

■ Setting the crossover frequency—CROSSOVER

Small speakers cannot reproduce the bass sounds efficiently. If you use a small speaker in any position, this receiver automatically reallocates the bass sound elements assigned to the small speaker to the large speakers.

To use this function properly, set this crossover frequency level according to the size of the small speaker connected.

- If you have selected “LARGE” for all speakers (see page 21), this function will not take effect (“CROSSOVER: OFF” appears).

CROSSOVER: 80Hz Select when the cone speaker unit built in the speaker is about 12 cm.

CROSSOVER: 100Hz Select when the cone speaker unit built in the speaker is about 10 cm.

CROSSOVER: 120Hz Select when the cone speaker unit built in the speaker is about 8 cm.

CROSSOVER: 150Hz Select when the cone speaker unit built in the speaker is about 6 cm.

CROSSOVER: 200Hz Select when the cone speaker unit built in the speaker is less than 5 cm.

Initial setting: CROSSOVER: 150Hz

NOTE

Crossover frequency is not valid for the HEADPHONE and 3D HEADPHONE modes.

■ Setting the low frequency effect attenuator —LFE ATT

If the bass sound is distorted while playing back software encoded with **Dolby Digital** or **DTS**, set the LFE level to eliminate distortion.

- This function takes effect only when the LFE signals come in.

LFE ATT: 0dB Normally select this.

LFE ATT: -10dB Select when the bass sound is distorted.

Initial setting: LFE ATT: 0dB

Using the Midnight mode —MIDNIGHT MODE

You can enjoy a powerful sound at night using the Midnight mode.

- Once you have made an adjustment, it is memorized for each source.

MIDNIGHT MODE: OFF

Select when you want to enjoy surround with its full dynamic range. (No effect applied.)

MIDNIGHT MODE: 1

Select when you want to reduce the dynamic range a little.

MIDNIGHT MODE: 2

Select when you want to apply the compression effect fully (useful at night).

Initial setting: MIDNIGHT MODE: OFF

From the remote control

You can also make adjustments the following way from the remote control.

Set the mode selector to "AUDIO/TV/VCR/DBS."

Press **SOUND**, then press **MIDNIGHT** repeatedly to select either one of the above.

NOTE

After pressing **SOUND**, the numeric buttons work for sound adjustments. To use the numeric buttons to operate your target source, press the corresponding source selecting button before operation; otherwise, the remote control may not work as you intend.

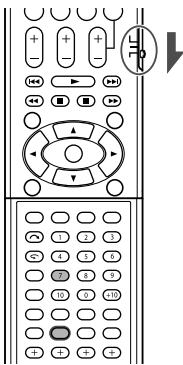

Setting the digital input (DIGITAL IN) terminals—DIGITAL IN 1/2/3

When you use the digital input terminals, register what components are connected to which terminals—DIGITAL IN 1/2/3 (see page 11) so that the correct source name will appear when you select the digital source.

Select one of the following components for each terminal:

DVR/DVD For the DVD player (or DVD recorder).

DBS For the DBS tuner.

VCR For the VCR.

TV For the TV.

Initial setting: DVR/DVD (for "DIGITAL IN 1")
DBS (for "DIGITAL IN 2")
VCR (for "DIGITAL IN 3")

NOTES

- You cannot assign the same component for different terminals. The priority order for assignment is as follows: "DIGITAL IN 1" > "DIGITAL IN 2" > "DIGITAL IN 3." "DIGITAL IN 1" can be set to any component.
Ex.: When "DIGITAL IN 1" is set to "TV,"
DIGITAL IN 1:
"DVR/DVD," "DBS," and "VCR" are selectable for "DIGITAL IN 2."
And when "DIGITAL IN 2" is set to "DVR/DVD,"
DIGITAL IN 1:
DIGITAL IN 2:
"DBS" and "VCR" are selectable for "DIGITAL IN 3."
- Setting "DIGITAL IN 1" affects "DIGITAL IN 2" and "DIGITAL IN 3" settings. When you have changed "DIGITAL IN 1," confirm the components assigned to "DIGITAL IN 2" and "DIGITAL IN 3."

Selecting the component video input mode—DVD VIDEO INPUT/VCR VIDEO INPUT

When you use the component video inputs for connecting the DVD recorder (or DVD player) or VCR, register the type of video input jacks.

If you have not selected appropriate video input jacks, you cannot view the playback picture on the TV or the AV COMPU LINK remote control system cannot operate properly (see page 40).

For the DVD recorder or DVD player (DVD VIDEO):

DVD VIDEO: S/C

Select when connecting the DVD recorder (or DVD player) to the composite video or S-video input jacks.

DVD VIDEO: COMPONENT

Select when connecting the DVD recorder (or DVD player) to the component video input jacks.

Initial setting: DVD VIDEO: S/C

For the VCR (VCR VIDEO):

VCR VIDEO: S/C

Select when connecting the VCR to the composite video or S-video input jacks.

VCR VIDEO: COMPONENT

Select when connecting the VCR to the component video input jacks.

Initial setting: VCR VIDEO: S/C

Superimposing the menus —SUPERIMPOSE

You can select whether or not to superimpose the on-screen display on the TV screen.

SUPERIMPOSE: ON

Select to superimpose the on-screen display on the TV screen.

SUPERIMPOSE: OFF

Select to cancel superimposition. The on-screen display will be shown on the blue background screen.

Initial setting: SUPERIMPOSE: ON

NOTES

- Some on-screen displays appear on the TV screen regardless of this setting.
- The on-screen display does not appear on the TV screen when connecting the TV through the COMPONENT MONITOR OUT jacks (see page 10).

Converting S-video signals into composite video signals—DOWN MIX

You can select whether or not to convert S-video signals into composite video signals.

DOWN MIX: ON Select to convert S-video signals into composite video signals.

DOWN MIX: OFF Select not to use this function.

Initial setting: DOWN MIX: OFF

NOTES

- This function is available when satisfying all the following requirements:
 - When a video component is connected to this receiver through at least one of the S-video input terminals.
 - When a video component or the TV is connected to this receiver through at least one of the composite video output jacks.
 - Either the DVD VIDEO INPUT or VCR VIDEO INPUT is set to “S/C” (see left column).
- When using this function, set the input mode of the TV correctly. (Refer also to the manual supplied with the TV.)

Converting composite video signals into S-video signals—Y/C SEPARATE

You can select whether or not to convert composite video signals come from a video component into S-video signals.

Y/C SEPARATE: ON Select to convert composite video signals into S-video signals.

Y/C SEPARATE: OFF Select not to use this function.

Initial setting: Y/C SEPARATE: OFF

NOTES

- This function is available when satisfying all the following requirements:
 - When a video component is connected to this receiver through at least one of the composite video input jacks.
 - When a video component or the TV is connected to this receiver through at least one of the S-video output terminals.
 - Either the DVD VIDEO INPUT or VCR VIDEO INPUT is set to “S/C” (see left column).
- When using this function, set the input mode of the TV correctly. (Refer also to the manual supplied with the TV.)

Sound adjustments

You can make sound adjustment to your preference after completing basic setting.

Basic adjustment items

You can adjust the following items. See pages in parentheses for details.

- You cannot select the items which is not available with the current setting.
- The name of the item shown below is the on-screen display indication and the name in parentheses is the display indication.

Items and to do	
SUBWOOFER LEVEL (SUBWFR LVL) Adjust the subwoofer output level. (29)	BASS BOOST (BASS BOOST) Boost the bass level. (30)
FRONT L LEVEL (FRONT L LVL) Adjust the left front speaker output level. (29)	SUBWFR PHASE (SBWFR PHASE) Select the subwoofer sound phase. (30)
FRONT R LEVEL (FRONT R LVL) Adjust the right front speaker output level. (29)	INPUT ATT (INPUT ATT) Attenuate the input level of analog source. (30)
CENTER LEVEL (CENTER LVL) Adjust the center speaker output level. (29)	EFFECT (EFFECT) Adjust the effect level. (31)
SURR. L LEVEL (SURR L LVL) Adjust the left surround speaker output level. (29)	PANORAMA (PANORAMA) Add wraparound sound effect with side-wall image. (31)
SURR. R LEVEL (SURR R LVL) Adjust the right surround speaker output level. (29)	CENTER GAIN (CENTER GAIN) Adjust the sound localization of the center channel. (31)
SURR. BACK LEVEL (S BACK LVL) Adjust the surround back speaker output level. (29)	CENTER TONE (CENTER TONE) Make the center tone soft or sharp. (31)
DIGITAL EQ 63Hz (D EQ 63Hz)* DIGITAL EQ 250Hz (D EQ 250Hz)* DIGITAL EQ 1kHz (D EQ 1kHz)* DIGITAL EQ 4kHz (D EQ 4kHz)* DIGITAL EQ 16kHz (D EQ 16kHz)* Adjust the equalization pattern of each band. (30)	CNTR ALIGNMENT (CNTR ALIGN) Align the vertical localization of the center channel. (31)

* If you have used Smart Surround Setup on pages 16 and 17, these settings are not required.

Operation through on-screen display menus

You can make adjustments to the basic settings easily by using the on-screen display menus.

Menu operation buttons

On the front panel:

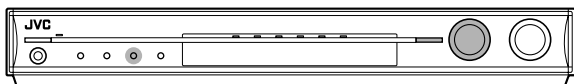

Button / JOG	To do
ADJUST button	show adjustment item previously selected.
SET button	move to the selected menu or return to the previous ADJUST MENU.
MULTI JOG	<ul style="list-style-type: none"> • select a menu or an item. • change a setting.

From the remote control:

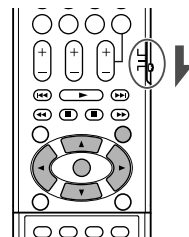

When operating the receiver using the remote control, set the mode selector to "AUDIO/TV/VCR/DBS."

Button	To do
MENU button	show "TOP MENU."
▲ / ▼ buttons	select a menu or an item.
SET button	move to the selected menu or return to the previous ADJUST MENU.
◀ / ▶ buttons	change a setting.

Setup menu configuration

- Items on the menus shown below are all set to the initial values when shipping from the factory.
- Some of the menus or some items on the menu cannot be shown or cannot be adjusted depending on the current settings and the connections. (For details, see the respective explanations in this section.)
- The "ADJUST MENU (3)" screen cannot be shown depending on the current settings and the connections.

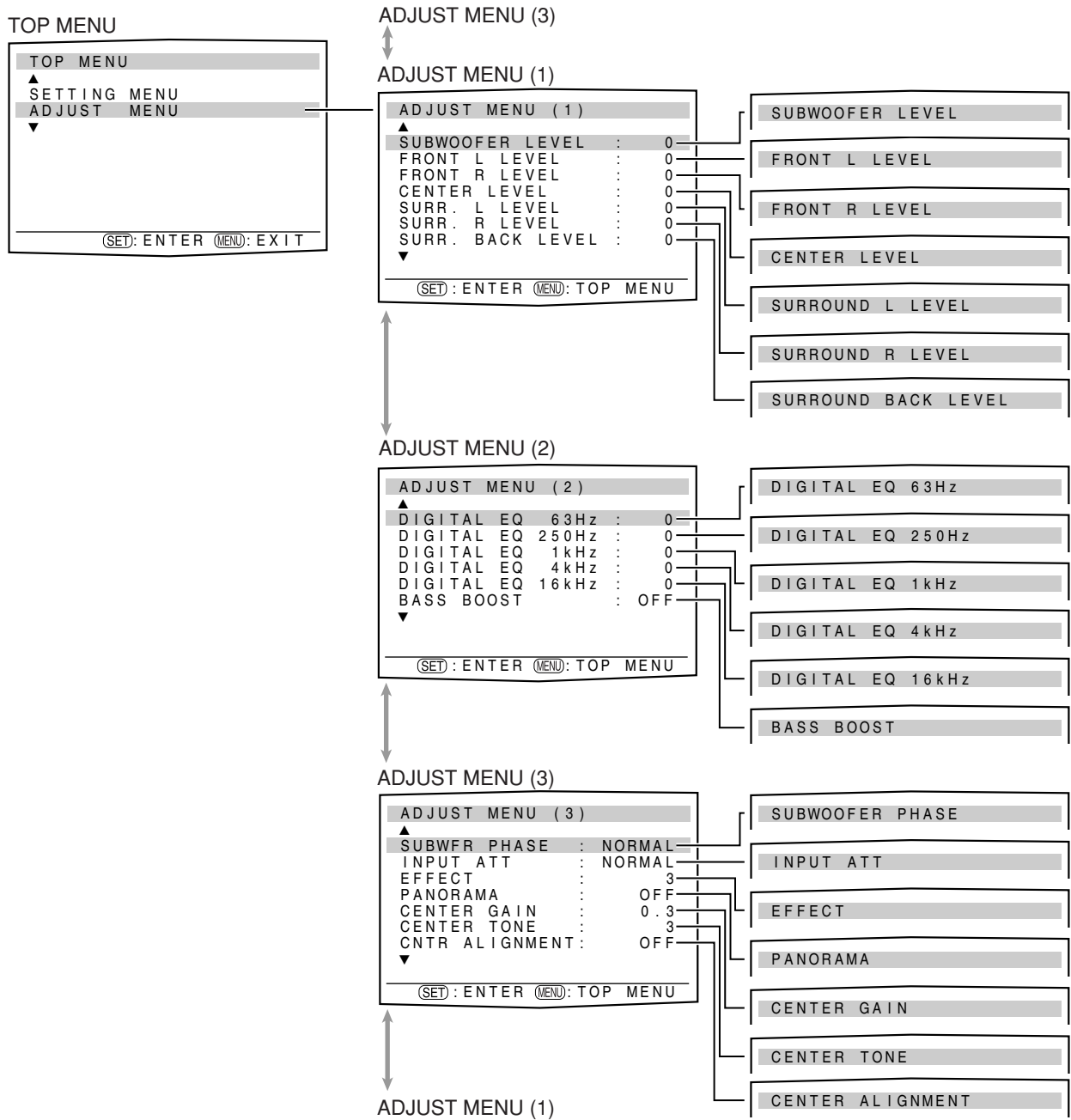

Menu operating procedure

When operating, the on-screen display appears on the TV screen regardless of the SUPERIMPOSE setting (see page 25).

Before you start, remember...

There is a time limit in doing the following steps. If the setting is canceled before you finish, start from step 1 again.

In this section, the operation of the remote control is used for explaining.

Ex.: When adjusting subwoofer output level.

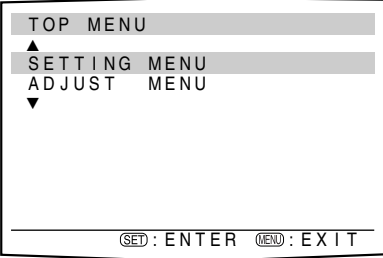
Operations	On the TV screen	On the display
<p>1 To show “TOP MENU,” press MENU. Then press ▲ or ▼ to select “ADJUST MENU.”</p> <ul style="list-style-type: none"> On the front panel, turn MULTI JOG. 	 <p>“TOP MENU” appears.</p>	<div style="border: 1px solid black; padding: 5px; width: fit-content; margin: 0 auto;">SETTING</div> <p>“SETTING” appears.</p>

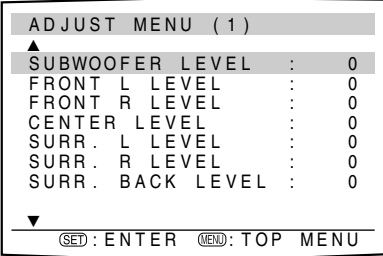
<p>2 To select “ADJUST MENU,” press SET.</p>	 <p>The adjustment item previously selected appears.</p>	<div style="border: 1px solid black; padding: 5px; width: fit-content; margin: 0 auto;">SUBWFR LVL</div> <p>The submenu previously selected appears.</p>
---	---	--

3 To select the desired submenu, press ▲ or ▼ repeatedly.

There are three screens from “ADJUST MENU (1)” to “ADJUST MENU (3).” To change the screen, simply pressing ▲ or ▼ repeatedly. You can go to the next/previous screen.

- On the front panel, turn MULTI JOG.

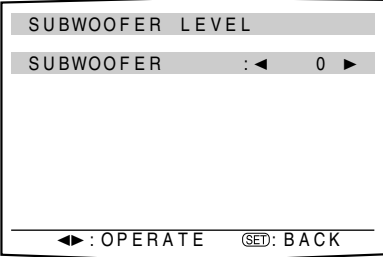
<p>4 Press SET.</p>	 <p>The selected submenu appears.</p>	<div style="border: 1px solid black; padding: 5px; width: fit-content; margin: 0 auto;">SUBWFR 0</div> <p>The current setting of the selected item appears.</p>
----------------------------	---	---

5 To adjust the selected item, press ◀ or ▶ repeatedly, then press SET.

The on-screen display returns to the previous ADJUST MENU. In this example, “ADJUST MENU (1)” appears on the TV screen and “SUBWFR LVL” appears on the display.

- On the front panel, turn MULTI JOG, then press SET.

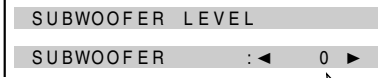
	<div style="border: 1px solid black; padding: 5px; width: fit-content; margin: 0 auto;">SUBWFR 0</div>
<div style="border: 1px solid black; padding: 5px; width: fit-content; margin: 0 auto;"> -10 ◀-----▶ 0 ◀-----▶ +10 </div>	

6 Repeat steps 2 to 5 to set other items if necessary.

NOTES

- To return to "TOP MENU," press MENU on the remote control.
- To exit from menu operations, press MENU on the remote control when "TOP MENU" appears. On the front panel, press ADJUST when a menu except "TOP MENU" appears.
- The adjustment item previously selected can be shown on the TV screen by pressing ADJUST on the front panel when the receiver is in normal operation mode.

Button indications on the screen

The buttons for operating the menu are shown on the TV screen. You can operate the menu with these buttons.

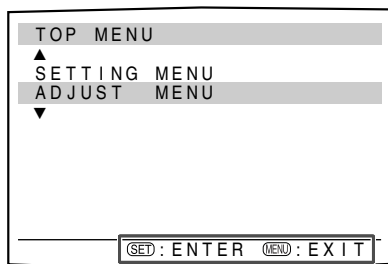

Usable buttons and their functions

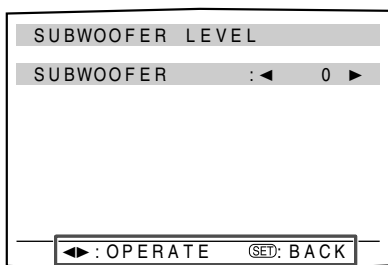

Usable buttons and their functions

Adjusting the items

When performing the basic settings viewing the indications on the display, the indications are slightly different from what is shown on the on-screen display.

This is because of the limited number of characters shown on the display.

- Ex.:
- "SUBWOOFER: +10" is shown as "SUBWFR +10" on the display.
 - "BASS BOOST: ON" is shown as "B BOOST ON" on the display.

Adjusting speaker output level

- **SUBWOOFER LEVEL** (subwoofer output level),
- **FRONT L LEVEL** (left front speaker output level),
- **FRONT R LEVEL** (right front speaker output level),
- **CENTER LEVEL** (center speaker output level),
- **SURROUND L LEVEL** (left surround speaker output level),
- **SURROUND R LEVEL** (right surround speaker output level),
- **SURROUND BACK LEVEL** (surround back speaker output level)

You can adjust the speaker output levels.

Adjust all the speakers' output levels so that you can listen to the sounds from all the speakers at the same level.

- Once you have made an adjustment, it is memorized for each source.

Adjustable range: -10 (dB) to +10 (dB) (in 1 step intervals)

Initial setting: 0 (dB) for all speakers

NOTES

- If you have selected "NO" for a speaker (see page 21), the output level for the corresponding speaker is not adjustable.
- While using the headphones, you can adjust only the left and right front speakers' output level.

From the remote control:

You can also make adjustments the following way from the remote control.

Set the mode selector to "AUDIO/TV/VCR/DBS."



1 Press TEST TONE to check the speakers' output balance.

- On the TV screen, "TEST TONE" appears. The » indicator corresponding to the speaker appears while a test tone comes out of the speakers.

EX.:

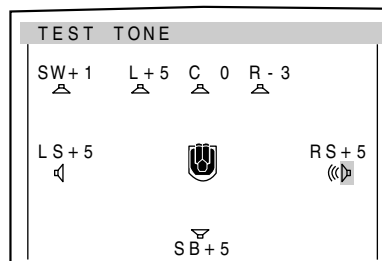

- On the display, "TEST L" starts flashing, and a test tone comes out of the speakers in the following order:

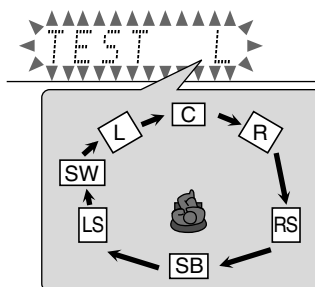

2 Adjust the speaker output levels.

To adjust the left front speaker level (L), press FRONT L +/-.

To adjust the right front speaker level (R), press FRONT R +/-.

To adjust the center speaker level (C), press CENTER +/-.

To adjust the left surround speaker level (LS), press SURR L +/-.

To adjust the right surround speaker level (RS), press SURR R +/-.

To adjust the surround back speaker level (SB), press S.BACK +/-.

To adjust the subwoofer level (SW), press SUBWFR +/-.

3 Press TEST TONE again to stop the test tone.

NOTES

- You can adjust the speaker output levels without the test tone.
- No test tone comes out of the speakers and no speaker indication appears on the TV screen corresponding to the speaker which is set to "NO" in the speaker setting (see page 21).
- No test tone is available when the headphone is in use or "DVD MULTI" is selected.

Adjusting the equalization patterns —DIGITAL EQ 63Hz/250Hz/1kHz/4kHz/16kHz

You can adjust equalization patterns in five frequency bands (center frequency: 63 Hz, 250 Hz, 1 kHz, 4 kHz, 16 kHz) for the front speakers.

- Once you have made an adjustment, it is memorized for each source.

Adjustable range: -8 (dB) to +8 (dB) (in 2 dB intervals)

Initial setting: 0 (dB) for all bands

- When adjustment is made, the EQ indicator lights up on the display.

If no adjustment is required, set all the frequency bands to "0 (dB)."

- The EQ indicator goes off from the display.

From the remote control:

You can also make adjustments the following way from the remote control.

Before you start, remember...

There is a time limit in doing the following steps. If the setting is canceled before you finish, start from step **2** again.

Set the mode selector to "AUDIO/TV/VCR/DBS."

- 1 Press SOUND.**
- 2 Press EQ FREQ repeatedly to select the band you want to adjust.**
- 3 Press EQ LEVEL \oplus/\ominus to adjust the equalization pattern of the selected band.**
- 4 Repeat steps 2 and 3 to adjust other bands.**

NOTE

After pressing SOUND, the numeric buttons work for sound adjustments. To use the numeric buttons to operate your target source, press the corresponding source selecting button before operation; otherwise, the remote control may not work as you intend.



Adjusting the bass sounds

■ Reinforcing the bass—BASS BOOST

You can boost the bass level—Bass Boost.

- Once you have made an adjustment, it is memorized for each source.

BASS BOOST: ON Select to boost the bass level.
The BASS indicator lights up on the display.

BASS BOOST: OFF Select to deactivate the Bass Boost.

Initial setting: BASS BOOST: OFF

NOTE

This function affects only the sound coming out through the front speakers.

From the remote control:

You can also make adjustments the following way from the remote control.

Set the mode selector to "AUDIO/TV/VCR/DBS."

Press SOUND, then press BASS BOOST repeatedly.

- Each time you press BASS BOOST, the Bass Boost turns on and off alternately.

NOTE

After pressing SOUND, the numeric buttons work for sound adjustments. To use the numeric buttons to operate your target source, press the corresponding source selecting button before operation; otherwise, the remote control may not work as you intend.

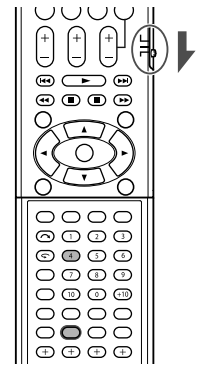

■ Selecting the subwoofer sound phase— SUBWOOFER PHASE

You can change the subwoofer sound phase to your preference.

- Once you have made an adjustment, it is memorized for each source.

PHASE: NORMAL Normally select this.

PHASE: REVERSE Select this when you feel the bass sound is better with this mode rather than with "PHASE: NORMAL."

Initial setting: PHASE: NORMAL

NOTE

This function takes effect only when "SUBWOOFER" is set to "SUBWOOFER: YES" (see page 21).

■ Attenuating the input signal—INPUT ATT

When the input level of **analog source** is too high, the sound will be distorted. If this happens, you need to attenuate the input signal level to prevent the sound distortion.

- Once you have made an adjustment, it is memorized for each source.

INPUT ATT: ON Select to attenuate the input signal level.
The ATT indicator lights up on the display.

INPUT ATT: NORMAL Select to deactivate attenuation.

Initial setting: INPUT ATT: NORMAL

Adjusting the sound parameters for the Surround/DSP modes

You can adjust the Surround/DSP sound parameters to your preference.

- For details about the Surround/DSP modes, see pages 34 to 39.

■ Adjusting the effect level for DSP modes —EFFECT

This setting is available only when one of the DSP modes (except ALL CH ST) is in use. To activate DSP mode, see page 39.

- Once you have made an adjustment, it is memorized for each DSP mode.

Adjustable range: 1 to 5 (in 1 step intervals)

Initial setting: EFFECT: 3

As the number increases, the effect becomes stronger.

Normally, select "3."

From the remote control:

You can also make adjustments the following way from the remote control.

Set the mode selector to "AUDIO/TV/VCR/DBS."

Press **SOUND**, then press **EFFECT** repeatedly.

NOTE

After pressing **SOUND**, the numeric buttons work for sound adjustments. To use the numeric buttons to operate your target source, press the corresponding source selecting button before operation; otherwise, the remote control may not work as you intend.

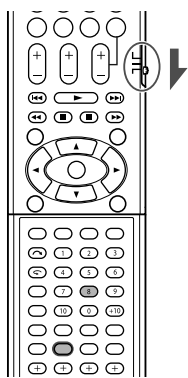

■ Making the center tone soft or sharp —CENTER TONE

This setting is available when one of the Surround/DSP modes is in use. To activate Surround/DSP mode, see page 39.

- This setting is common to all Surround modes, and is memorized separately for DSP modes.
- You cannot adjust the center tone in the following cases:
 - When "CENTER SPEAKER" is set to "CENTER SPK: NO" (see page 21).
 - When Dual Mono software is played back.
 - While listening with the headphones.

Adjustable range: 1 to 5 (in 1 step intervals)

Initial setting: CENTER TONE: 3

As the number increases, the dialogue becomes stronger.

Normally, select "3."

- When the center tone is set to other than "CENTER TONE: 3," the C.TONE indicator lights up on the display.

From the remote control:

You can also make adjustments the following way from the remote control.

Set the mode selector to "AUDIO/TV/VCR/DBS."

Press **SOUND**, then press **C.TONE** repeatedly.

NOTE

After pressing **SOUND**, the numeric buttons work for sound adjustments. To use the numeric buttons to operate your target source, press the corresponding source selecting button before operation; otherwise, the remote control may not work as you intend.

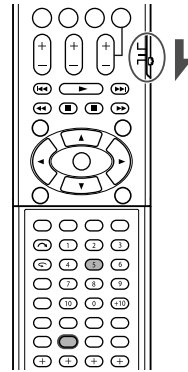

■ Adjusting the panorama control for Pro Logic II Music—PANORAMA

This setting is available only when Pro Logic II Music is in use. To activate Pro Logic II Music, see page 39.

- Once you have made an adjustment, it is memorized until you change the setting.

PANORAMA: ON Select to add "wraparound" sound effect with side-wall image.

PANORAMA: OFF Select to listen to originally recorded sound.

Initial setting: PANORAMA: OFF

■ Adjusting the sound localization of the center channel—CENTER GAIN

This setting is available only when Neo:6 Music is in use.

- If you have set "CENTER SPEAKER" to "CENTER SPK: NO" (see page 21), the center gain is not adjustable.
- Once you have made an adjustment, it is memorized until you change the setting.

Adjustable range: 0 to 1.0 (in 0.1 step intervals)

Initial setting: CENTER GAIN: 0.3

As the number increases, the center channel will be localized clearly.

Normally, select "0.3."

■ Align the vertical localization of the center channel —CENTER ALIGNMENT

This setting is available when one of the Surround/DSP modes (except "PLII MUSIC," "PLIIX MUSIC," "Neo:6 MUSIC," and "ALL CH ST") is in use. To activate Surround/DSP mode, see page 39.

- Once you have made an adjustment, it is memorized for each Surround/DSP mode.
- You cannot adjust the center alignment in the following cases:
 - When "CENTER SPEAKER" is set to "CENTER SPK: NO" (see page 21).
 - When Dual Mono software is played back.
 - While listening with the headphones.

C ALIGNMENT: ON Select when you cannot feel as if the actors or singers are speaking or singing on the screen.

C ALIGNMENT: OFF Select not to use this function.

Initial setting: C ALIGNMENT: OFF

Tuner operations

Tuner operations are mainly done from the remote control.

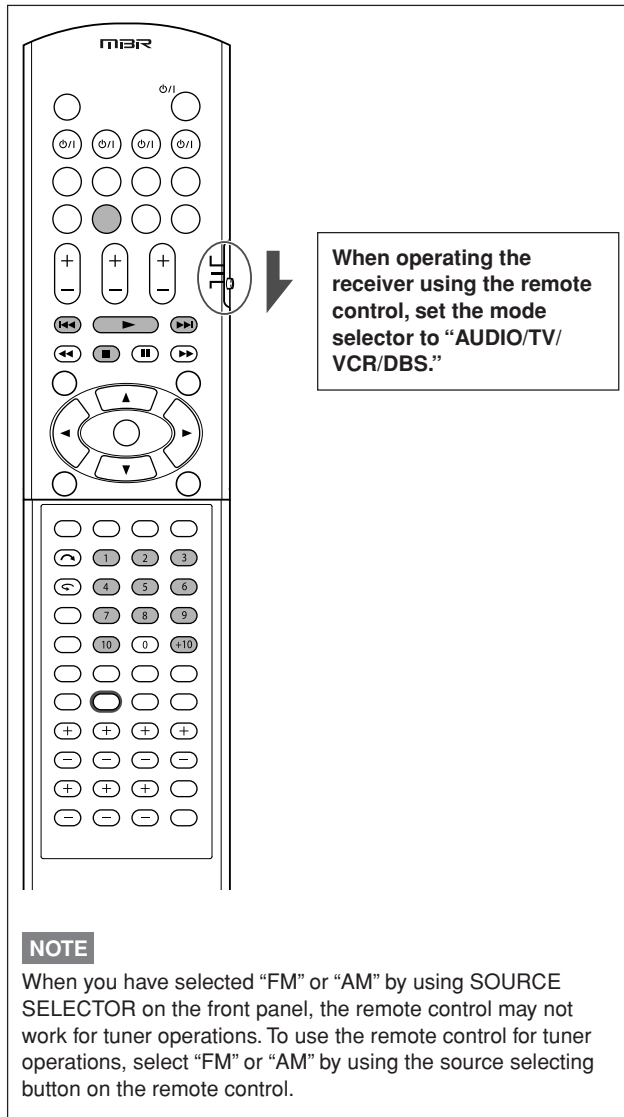

Tuning in to stations manually

From the remote control ONLY:

1 Press FM/AM to select the band.

- The last received station of the selected band is tuned in.
- Each time you press the button, the band alternates between "FM" and "AM."

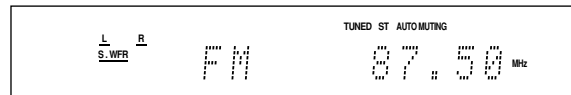

2 Press repeatedly or hold TUNING + or - TUNING until the station you want is tuned in.

- Pressing (or holding) TUNING + increases the frequency.
- Pressing (or holding) - TUNING decreases the frequency.

NOTES

- When you hold and release TUNING + or - TUNING, the frequency keeps changing until a station is tuned in.
- When a station of sufficient signal strength is tuned in, the TUNED indicator lights up on the display.
- When an FM stereo program is received, the ST (stereo) indicator also lights up.

Using preset tuning

Once a station is assigned a channel number, the station can be quickly tuned simply by selecting the number. You can preset up to 30 FM and 15 AM stations.

To store the preset stations

Before you start, remember...

There is a time limit in doing the following steps. If the setting is canceled before you finish, start from step 2 again.

From the remote control ONLY:

1 Tune in to the station you want to preset (see "Tuning in to stations manually" above).

- If you want to store the FM reception mode for this station, select the FM reception mode you want. See "Selecting the FM reception mode" on page 33.

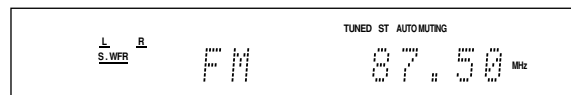

2 Press MEMORY.

The channel number position starts flashing on the display for about 5 seconds.



3 Press the numeric buttons (1 – 10, +10) to select a channel number while the channel number position is flashing.

- For channel number 5, press 5.
- For channel number 15, press +10, then 5.
- For channel number 30, press +10, +10, then 10.

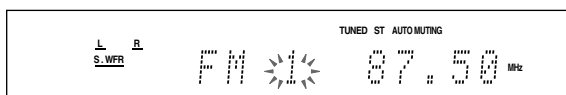

4 Press MEMORY again while the selected channel number is flashing on the display.

The selected channel number stops flashing.
The station is assigned to the selected channel number.

5 Repeat steps 1 to 4 until you store all the stations you want.

To erase a stored preset station

Storing a new station on a used channel number erases the previously stored one.

To tune in a preset station

From the remote control:

1 Press FM/AM to select the band.

The last received station of the selected band is tuned in and the numeric buttons now work for tuner operations.

- Each time you press the button, the band alternates between “FM” and “AM.”

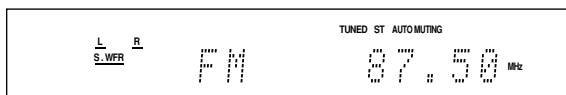

2 Press the numeric buttons (1 – 10, +10) to select a preset channel number.

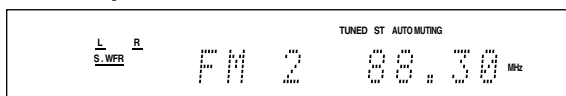

- For channel number 5, press 5.
- For channel number 15, press +10, then 5.
- For channel number 30, press +10, +10, then 10.

On the front panel:



Before you start, remember...

There is a time limit in doing the following steps. If the setting is canceled before you finish, start from step 2 again.

1 Turn SOURCE SELECTOR to select “FM” or “AM.”

The last received station of the selected band is tuned in.

2 Press TUNER PRESET.

“P” appears on the display and MULTI JOG now works for selecting preset channels.

3 Turn MULTI JOG to select a preset channel number while “P” appears on the display.

- To increase the preset channel numbers, turn MULTI JOG clockwise.
- To decrease the preset channel numbers, turn MULTI JOG counterclockwise.

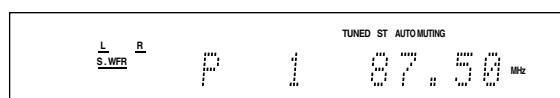

Selecting the FM reception mode

When an FM stereo broadcast is hard to receive or noisy, you can change the FM reception mode while receiving an FM broadcast.

- You can store the FM reception mode for each preset station (see page 32).

From the remote control ONLY:

While listening to an FM station, press FM MODE.

- Each time you press the button, the FM reception mode alternates between “AUTO MUTING” and “MONO.”

AUTO MUTING

Normally select this.
When a program is broadcast in stereo, you will hear stereo sound; when in monaural, you will hear monaural sound. This mode is also useful to suppress static noise between stations. The AUTO MUTING indicator lights up on the display.

MONO

Select this to improve the reception (but stereo effect will be lost).
In this mode, you will hear noise while tuning in to the stations. The AUTO MUTING indicator goes off from the display. (The ST indicator also goes off.)

Initial setting: AUTO MUTING

Creating realistic sound fields

Reproducing theater ambience

In a movie theater, many speakers are located on the walls to reproduce impressive multi-channel sound, reaching you from all directions.

With these many speakers, sound localization and sound movement can be expressed.

Surround/DSP modes built in this receiver can create almost the same Surround sound as you can feel in a real movie theater.

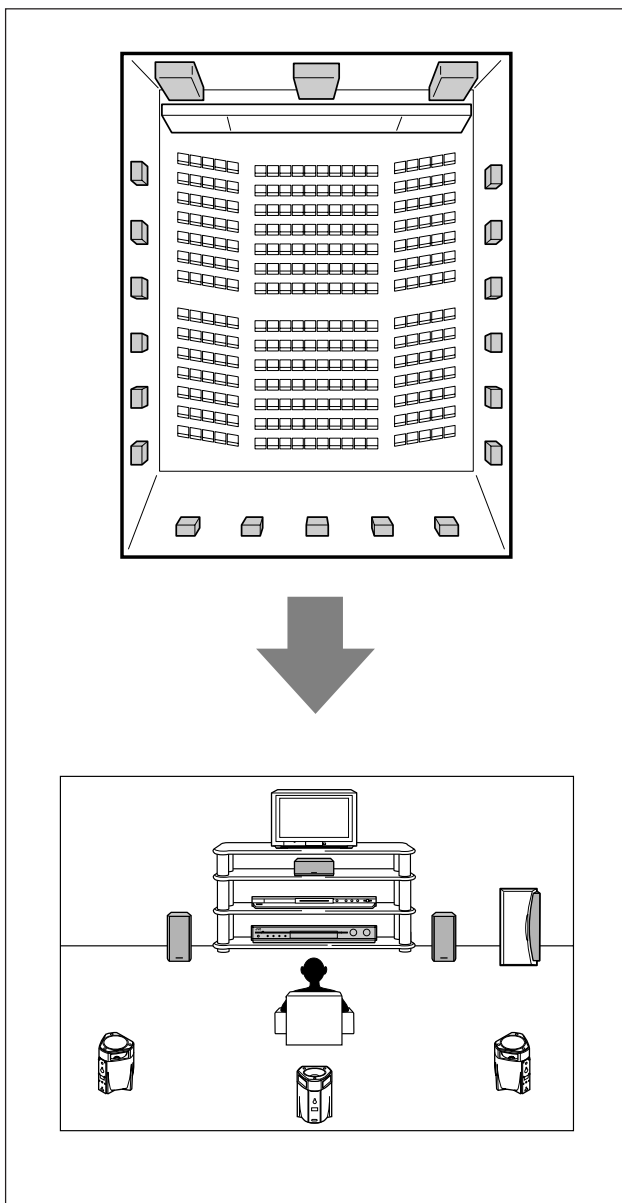

Introducing the Surround modes

■ Dolby Digital*

Dolby Digital is a digital signal compression method, developed by Dolby Laboratories, and enables multi-channel encoding and decoding.

- When Dolby Digital signal is detected through the digital input, the **DOLBY D** indicator lights up on the display.

Dolby Digital 5.1CH

Dolby Digital 5.1CH (DOLBY D) encoding method records and digitally compresses the left front channel, right front channel, center channel, left surround channel, right surround channel, and LFE channel signals (total 6 channels, but the LFE channel is counted as 0.1 channel. Therefore, called 5.1 channel).

Dolby Digital enables stereo surround sounds, and sets the cutoff frequency of the surround treble at 20 kHz, compared to 7 kHz for Dolby Pro Logic. As such, the sound movement and “being-there” feeling are enhanced much more than Dolby Pro Logic.

Dolby Digital EX

Dolby Digital EX (DOLBY D EX) is a digital surround encoding format that adds the third surround channels, called “surround back.”

Compared to the conventional Dolby Digital 5.1CH, these newly added surround back channels can reproduce more detailed movements behind you while viewing the video software. In addition, surround sound localization will become more stable.

■ Dolby Surround

Dolby Pro Logic II

Dolby Pro Logic II is a multi-channel playback format to convert 2-channel software into 5-channel (plus subwoofer). The matrix-based conversion method used for Dolby Pro Logic II makes no limitation for the cutoff frequency of the surround treble and enables stereo surround sound.

- This receiver provides two types of Dolby Pro Logic II modes—**Pro Logic II Movie** (PLII MOVIE) and **Pro Logic II Music** (PLII MUSIC).

When Dolby Pro Logic II is activated, the  **PL II** indicator lights up on the display.

PLII MOVIE Suitable for playing any Dolby Surround encoded software. You can enjoy a sound field very close to the one created with discrete 5.1-channel sounds.

PLII MUSIC Suitable for playing any 2-channel stereo software. You can enjoy wide and deep sounds.

Dolby Pro Logic IIx

Dolby Pro Logic IIx is a newly introduced multi-channel playback format to convert not only multi-channel software but 2-channel software into 6.1 channel (or 7.1 channel) that developed from Dolby Pro Logic II. The matrix-based conversion method used for Dolby Pro Logic IIx makes no limitation for the cutoff frequency of the surround treble.

- This receiver provides two types of Dolby Pro Logic IIx modes—**Pro Logic IIx Movie** (PLIIx MOVIE) and **Pro Logic IIx Music** (PLIIx MUSIC).

When Dolby Pro Logic IIx is activated, the  **PL IIx** indicator lights up on the display.

PLIIx MOVIE Suitable for playing any Dolby Surround encoded software. You can enjoy a sound field with a natural wraparound effect.

PLIIx MUSIC Suitable for playing any 2-channel stereo software. You can enjoy wide and deep 6.1-channel sounds.

- To enjoy software encoded with Dolby Digital, connect the source component using the digital terminal on the rear of this receiver. (See page 11.)

* Manufactured under license from Dolby Laboratories. "Dolby", "Pro Logic", and the double-D symbol are trademarks of Dolby Laboratories.

■ DTS**

DTS is another digital signal compression method, developed by Digital Theater Systems, Inc., and enables multi-channel encoding and decoding (1ch up to 6.1ch).

- When DTS signal is detected through the digital input, the **DTS** indicator lights up on the display.

DTS Digital Surround

DTS Digital Surround (DTS) is another discrete 5.1 channel digital audio format available on CD, LD, and DVD software. Compared to Dolby Digital, the DTS Digital Surround format has a lower audio compression rate which enables it to add breadth and depth to the sounds reproduced. As such, DTS Digital Surround features natural, solid, and clear sound.

DTS Extended Surround (DTS-ES)

DTS-ES is another multi-channel digital encoding format. It greatly improves the 360-degree surround impression and space expression by adding the third surround channel—surround back channel.

DTS-ES includes two signal formats with different surround signal recording methods—**DTS-ES Discrete 6.1ch** (ES DISCRETE) and **DTS-ES Matrix 6.1ch** (ES MATRIX).

DTS-ES Discrete 6.1ch has been designed to encode (and decode) a 6.1-channel signal discretely to avoid interference with each channel.

DTS-ES Matrix 6.1ch has been designed to add an extra surround channel to DTS Digital Surround 5.1-channel. By using a matrix encoding/decoding method, an additional "surround back" channel signal is encoded (and decoded) in both the left and right surround channel signals.

** "DTS", "DTS-ES", "Neo:6" and "DTS 96/24" are trademarks of Digital Theater Systems, Inc.

DTS 96/24

In recent years, there has been increasing interest in higher sampling rates both for recording and for reproducing at home. Higher sampling rates allow wider frequency range and greater bit depths provide extended dynamic range.

DTS 96/24 is a multi-channel digital signal format (fs 96 kHz/24 bits) introduced by Digital Theater Systems, Inc. to deliver "better-than-CD sound quality" into the home.

- When DTS 96/24 signal is detected, the **DTS** and **96/24** indicators light up. You can enjoy its 5.1-channel sound with full-quality.

DTS Neo:6

DTS Neo:6 is another conversion method to create 6-channel (plus subwoofer) from analog/digital 2-channel software by using the high precision digital matrix decoder used for DTS-ES Matrix 6.1ch.

- This receiver provides the following DTS Neo:6 modes—**Neo:6 Cinema** (NEO:6CINEMA) and **Neo:6 Music** (NEO:6 MUSIC). When one of them is activated, the **NEO:6** indicator lights up on the display.

NEO:6CINEMA Suitable for playing movies. You can get the same atmosphere with 2-channel software as with 6.1-channel software. It is also effective for playing software encoded with conventional surround formats.

NEO:6 MUSIC Suitable for playing music software. The front channel signals bypass the decoder (resulting in no loss of sound quality) and the surround signals transmitted through the other speakers expand the sound field naturally.

When using Surround mode, the sounds come out of the activated speakers which the Surround mode requires.

- **If either the surround speakers or center speaker is set to "NO" in the speaker setting (see page 21),** the corresponding channel signals are allocated to and emitted through the front speakers.
- **If both the surround speakers and center speaker are set to "NO" in the speaker setting (see page 21),** JVC's original 3D-PHONIC processing (which has been developed to create the surround effect through the front speakers only) is used. The 3D indicator lights up on the display.

3D HEADPHONE mode

If you connect a pair of headphones while one of the Surround modes is in use, the 3D HEADPHONE mode is activated without respect to the type of software played back. "3DHEADPHONE" appears on the display and the DSP, 3D, and HP indicators light up.

About other digital signals

Linear PCM

Uncompressed digital audio data used for DVDs, CDs, and Video CDs.

DVDs support 2 channels with sampling rates of 48/96 kHz, at quantization of 16/20/24 bits. On the other hand, CDs and Video CDs are limited to 2 channels with 44.1 kHz at 16 bits.

- When Linear PCM signal is detected, the LPCM indicator lights up.

Dual Mono

Dual Mono can be easily understood when you think of the bilingual broadcast for TV programs (however, the Dual Mono format is not identical with those analog formats).

This format is now adopted in Dolby Digital, DTS, and so on. It allows two independent channels (called main channel and sub-channel) to be recorded separately.

- You can select either channel you want to listen to (see page 23).

Introducing the DSP modes

The sound heard in a concert hall, club, etc. consists of direct sound and indirect sound—early reflections and reflections from behind. Direct sounds reach the listener directly without any reflection. On the other hand, indirect sounds are delayed by the distances of the ceiling and walls. These direct sounds and indirect sounds are the most important elements of the acoustic surround effects.

The DSP (Digital Signal Processor) modes can create these important elements, and give you a real “being there” feeling.

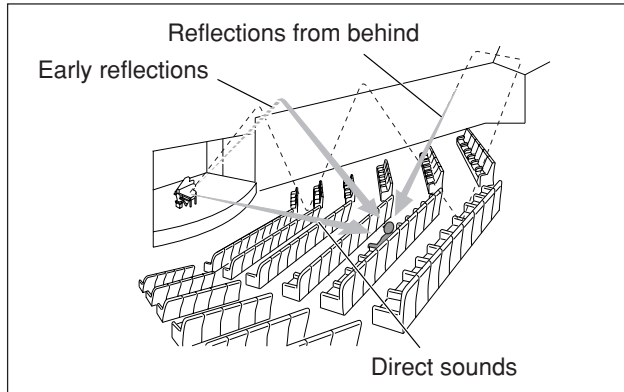

The DSP modes include the following modes:

- Digital Acoustic Processor (DAP) modes—HALL1, HALL2, LIVE CLUB, DANCE CLUB, PAVILION, THEATER1, THEATER2
- MONO FILM—Used for all types of 2-channel signals (including Dual Mono signal)
- All Channel Stereo mode (ALL CH ST)

When one of the DSP modes is activated, the DSP indicator lights up on the display.

Digital Acoustic Processor (DAP) modes

You can use the following DAP modes in order to reproduce a more acoustic sound field in your listening room.

HALL1	Reproduces the spatial feeling of a large shoebox-shaped hall designed primarily for classical concerts. (Its seating capacity is about 2000.)
HALL2	Reproduces the spatial feeling of a large vineyard-shaped hall designed primarily for classical concerts. (Its seating capacity is about 2000.)
LIVE CLUB	Reproduces the spatial feeling of a live music club with a low ceiling.
DANCE CLUB	Reproduces the spatial feeling of a rocking dance club.
PAVILION	Reproduces the spatial feeling of an exhibition hall with a high ceiling.
THEATER1	Reproduces the spatial feeling of a large theater where the seating capacity is about 600.
THEATER2	Reproduces the spatial feeling of a small theater where the seating capacity is about 300.

NOTE

When “THEATER1” or “THEATER2” is activated while playing back 2-channel analog or digital source, the built-in Dolby Pro Logic II decoder is activated and the PL II indicator lights up.

When using the DAP mode, the sounds come out of all the connected and activated speakers.

- If the surround speakers are set to “NO” in the speaker setting (see page 21), JVC’s original 3D-PHONIC processing (which has been developed to create the surround effect through the front speakers only) is used. The 3D indicator lights up on the display.

MONO FILM

In order to reproduce a more acoustic sound field in your listening room while viewing monaural sound video software (analog and 2-channel digital signals including Dual Mono signal), you can use this mode.

The surround effect will be added, and the sound localization of actor’s words will be improved.

This mode cannot be used for multi-channel digital signals.

When “MONO FILM” is used, sounds come out of all the connected (and activated) speakers.

- If the surround speakers are set to “NO” in the speaker setting (see page 21), JVC’s original 3D-PHONIC processing (which has been developed to create the surround effect through the front speakers only) is used. The 3D indicator lights up on the display.
- If incoming signals change from 2-channel digital signal to another digital signal type, “MONO FILM” is canceled and an appropriate Surround mode is activated.

All Channel Stereo mode (ALL CH ST)

This mode can reproduce a larger stereo sound field using all the connected (and activated) speakers.

This mode cannot be used if the surround speakers are set to “NO” in the speaker setting (see page 21).

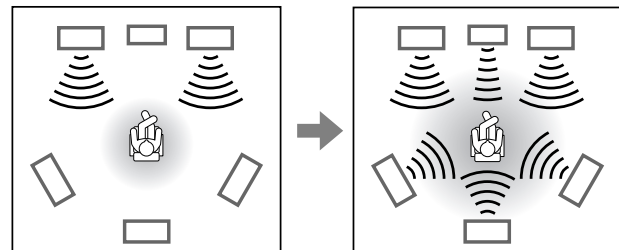

Sound reproduced from normal stereo

Sound reproduced from All Channel Stereo mode

3D HEADPHONE mode

If you connect a pair of headphones while one of the DSP modes is in use, the 3D HEADPHONE mode is activated without respect to the type of software played back. “3DHEADPHONE” appears on the display and the DSP, 3D, and HP indicators light up.

Using the Surround/DSP modes

Available Surround/DSP modes vary depending on the speaker settings and the incoming signals. See the table below.

- The numbers inside the parentheses following the incoming signal type indicate the number of the front channels and that of the surround channels. For example, (3/2) indicates that the signals are encoded with three front signals (left/right/center) and two (stereo) surround signals.
- For EX/ES/PLIIx setting, see page 22.

The name of the mode shown below is the display indication.

Incoming Signal Type		EX/ES/PLIIx setting				
		AUTO	ON	PLIIx MOVIE	PLIIx MUSIC	OFF
Dolby Digital	Dolby Digital Surround EX	DOLBY D EX*2*5	DOLBY D EX*2	DOLBY D EX*2*3	D + PLIIx MU*2	DOLBY D
	Dolby Digital (3/2, 2/2)	DOLBY D	DOLBY D EX*2	DOLBY D EX*2*3	D + PLIIx MU*2	DOLBY D
	Dolby Digital (3/1, 2/1, 3/0, 1/0)	DOLBY D				
	Dolby Digital (Dual Mono)	DUAL MONO				
DTS	DTS-ES Discrete*1	ES DISCRETE*2	ES DISCRETE*2	DTS + D EX*2*3	DTS + PLIIx MU*2	DTS
	DTS-ES Matrix*1	ES MATRIX*2	ES MATRIX*2	DTS + D EX*2*3	DTS + PLIIx MU*2	DTS
	DTS (3/2, 2/2)*1	DTS	DTS + NEO:6*2	DTS + D EX*2*3	DTS + PLIIx MU*2	DTS
	DTS (3/1, 2/1, 3/0, 1/0)	DTS				
	DTS (Dual Mono)	DUAL MONO				
Dolby Digital (2/0) DTS (2/0) Lenear PCM Analog		PLIIx MOVIE*4/PLIIx MUSIC*4/NEO:6CINEMA/NEO:6 MUSIC				PLII MOVIE PLII MUSIC NEO:6CINEMA NEO:6 MUSIC
DVD MULTI		None				

*1 DTS 96/24 processing is not applied when the EX/ES/PLIIx setting is activated. If you want to apply the processing, set the EX/ES/PLIIx setting to "EX/ES/PLIIx: OFF" (see page 22).

*2 When "SURROUND BACK SPEAKER" is set to "SURR. BACK SPK: NO" (see page 21), Virtual Surround Back is activated for the modes.

*3 When using PLIIx Movie to reproduce Dolby Digital or DTS software, this receiver applies Dolby Digital EX (DOLBY D EX) or DTS plus Dolby Digital EX (DTS + D EX) processing (6.1-channel reproduction) to the software.

*4 When "SURROUND BACK SPEAKER" is set to "SURR. BACK SPK: NO" (see page 21), "PLIIx MOVIE" is changed to "PLII MOVIE" and "PLIIx MUSIC" is changed to "PLII MUSIC."

*5 For some Dolby Digital Surround EX software, Dolby Digital 5.1-channel reproduction ("DOLBY D") may be applied. In this case, select "EX/ES/PLIIx: ON" to apply "DOLBY D EX."

About the DSP modes

- The following DSP modes are available regardless of incoming signal type:
HALL1, HALL2, LIVE CLUB, DANCE CLUB, PAVILION, THEATER1, THEATER2
- When an incoming signal is a multi-channel (more than 2-channel) digital signal, "MONO FILM" is not available.
- You cannot select "ALL CH ST" when the surround speakers are set to "NO" in the speaker setting (see page 21).

Virtual Surround Back

This function creates the great surround effect from the behind as if you have connected the surround back speaker. The VIRTUAL SB (Surround Back) indicator lights up on the display.

If you have connected (and activated) the surround speakers, you can use Virtual Surround Back without connecting the surround back speaker.

Virtual Surround Back is activated when "EX/ES/PLIIx" is set to other than "EX/ES/PLIIx: OFF" and when playing back the software including the following signals:

- Dolby Digital Surround EX
- DTS-ES
- Dolby Digital or DTS with more than 4-channels

Virtual Surround Back is activated when one of the Surround modes is selected.

Activating the Surround/DSP modes

Available Surround/DSP modes vary depending on the incoming signals. For details, see page 38.

Activating one of the Surround/DSP modes automatically recalls the memorized settings and adjustments.

- To adjust the speaker output level, see page 29.
- To adjust the effect level for the DSP mode (except All Channel Stereo mode,) see page 31.
- To add “wraparound” sound effect to “PLII MUSIC” (PANORAMA control,) see page 31.
- To adjust the sound localization of the center channel for “NEO:6 MUSIC” (center gain,) see page 31.
- To adjust the vertical localization of the center channel for Surround/DSP modes (except “PLII MUSIC,” “PLIIX MUSIC,” “Neo6: MUSIC,” and “ALL CH ST”) (center alignment,) see page 31.

NOTES

- You cannot use any Surround/DSP modes when selecting “DVD MULTI” as the playback source.
- The on-screen display appears on the TV screen to show the Surround/DSP mode name for 5 seconds when you select the Surround/DSP mode.
To cancel the function, set “SUPERIMPOSE” to “SUPERIMPOSE: OFF” (see page 25).

From the remote control:

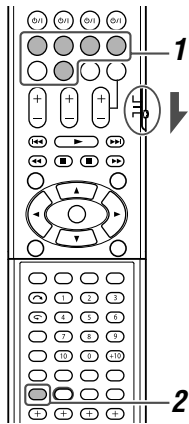

When operating the receiver using the remote control, set the mode selector to “AUDIO/TV/VCR/DBS.”

1 Select and play any source other than “DVD MULTI.”

- Make sure you have selected the input mode (analog or digital) correctly.

2 Press SURROUND repeatedly to select the Surround/DSP mode you want.

Ex.: When “DOLBY D” is selected for Dolby Digital multi-channel software:

DOLBY D

AUTO SURR	↔ Surround modes* ↔	
HALL1	↔ HALL2 ↔	
LIVE CLUB	↔ DANCE CLUB ↔	
PAVILION	↔ THEATER1 ↔	
THEATER2	↔ MONO FILM ↔	
ALL CH ST	↔ SURR OFF ↔	

(Back to the beginning)

To cancel Surround/DSP modes

Press SURROUND repeatedly so that “SURR OFF” appears on the display.

On the front panel:

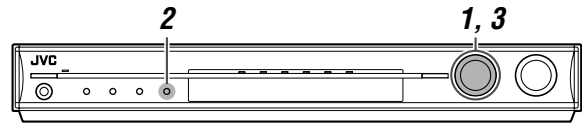

Before you start, remember...

There is a time limit in doing the following steps. If the setting is canceled before you finish, start from step 2 again.

1 Select and play any source other than “DVD MULTI.”

- Make sure you have selected the input mode (analog or digital) correctly.

2 Press SURROUND.

MULTI JOG now works for selecting Surround/DSP modes.

3 Turn MULTI JOG to select the Surround/DSP mode you want.

Ex.: When “DOLBY D” is selected for Dolby Digital multi-channel software:

DOLBY D

AUTO SURR	↔ Surround modes* ↔	
HALL1	↔ HALL2 ↔	
LIVE CLUB	↔ DANCE CLUB ↔	
PAVILION	↔ THEATER1 ↔	
THEATER2	↔ MONO FILM ↔	
ALL CH ST	↔ SURR OFF ↔	

(Back to the beginning)

To cancel Surround/DSP modes

Turn MULTI JOG so that “SURR OFF” appears on the display.

NOTE

The initial setting is “AUTO SURR.”

- * Available Surround modes vary depending on the incoming signals. For details, see “Using the Surround/DSP modes” on page 38.

When you select “AUTO SURR” (Auto Surround)

You can enjoy the Surround mode easily.

- For details about the Surround modes, see pages 34 to 36.
- When “AUTO SURR” is activated, the AUTO SR indicator lights up on the display.

How does “AUTO SURR” work?

- If a multi-channel signal comes in, an appropriate Surround mode will be selected automatically.
- If a Dolby Digital 2-channel or DTS 2-channel signal with surround signal comes in, “PLII MOVIE” will be selected.
- If a Dolby Digital 2-channel or DTS 2-channel signal without surround signal, or a Linear PCM signal comes in, “SURR OFF (stereo)” will be selected.

NOTES

- “AUTO SURR” does not take effect in the following cases:
 - While playing an analog source.
 - While selecting one of the fixed digital decode modes—“DOLBY D” or “DTS” (see page 13).
- While listening with the headphones, the 3D HEADPHONE mode (see pages 36 and 37) is activated without respect to the type of software played back.
- When “AUTO SURR” is selected, sound may not come out at the beginning of playback. If it occurs, select a Surround mode manually.

AV COMPU LINK remote control system

The AV COMPU LINK remote control system allows you to operate JVC's video components (TV, DVD player*, and VCR) through this receiver.

This receiver is equipped with the AV COMPU LINK-III, which has added a function to operate JVC's video components through the component video jacks. To use this remote control system, you need to connect the video components you want to operate, following the diagrams below and the procedures on page 41.

• Refer also to the manuals supplied with your video components.

* "DVD player" on pages 40 and 41 can be replaced with "DVD recorder."

Connections 1: AV COMPU LINK connection

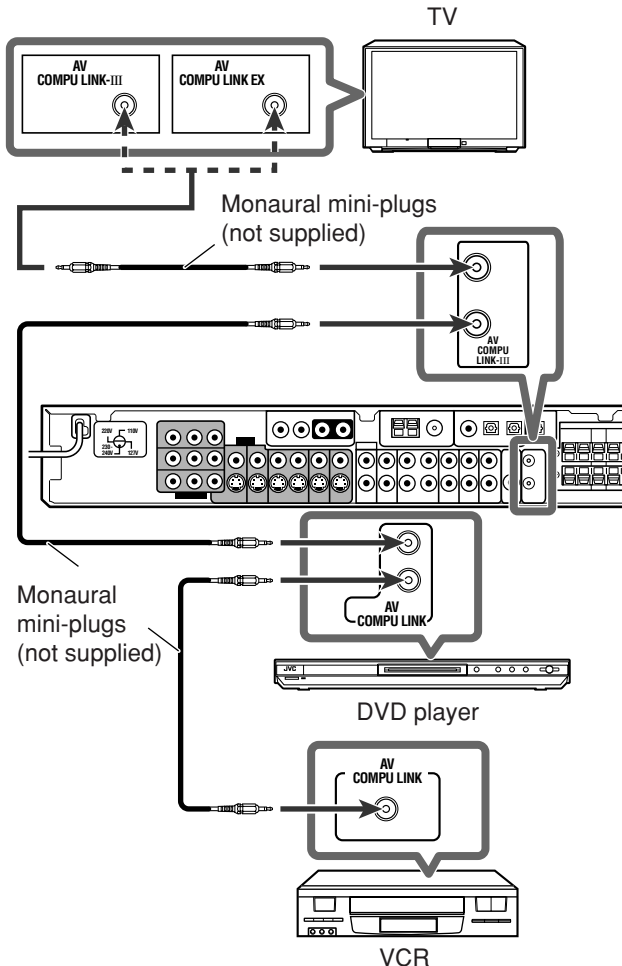

IMPORTANT:

The AV COMPU LINK remote control system cannot control the DBS tuner connected to the DBS IN jacks.

NOTES

- When connecting the receiver and a TV with the AV COMPU LINK EX terminal by using a component video cable, you cannot use Automatic selection of TV's input mode (see page 41).
- When connecting only the VCR and DVD player to this receiver, connect it directly to the receiver using cable with the monaural mini-plugs.
- You can connect only the TV with AV COMPU LINK EX or AV COMPU LINK-III terminal to the AV COMPU LINK-III terminal.

Connections 2: Video cable connection

This receiver is equipped with three types of the video terminals—composite video, S-video, and component video, and the signals coming into this receiver through one type of video terminals can output only through the terminal of the same type. So you need to connect the video components to this receiver using one of the following three ways.

- When using the AV COMPU LINK remote control system, set the video input for the DVD player and the VCR correctly (see "Selecting the component video input mode—DVD VIDEO INPUT/VCR VIDEO INPUT" on page 25); otherwise, the correct input for this receiver will not be selected on the TV.

Case 1*:

When connecting the source equipment to the receiver through the S-video terminals, connect this receiver to the TV's video input 1 terminal using S-video cables.

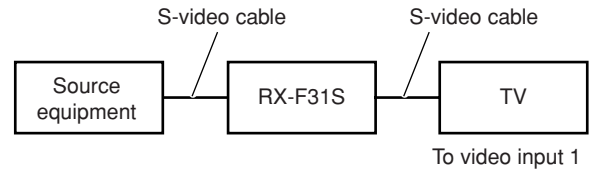

Case 2*:

When connecting the source equipment to the receiver through the composite video jacks, connect this receiver to the TV's video input 2 terminal (composite video input) using composite video cables.

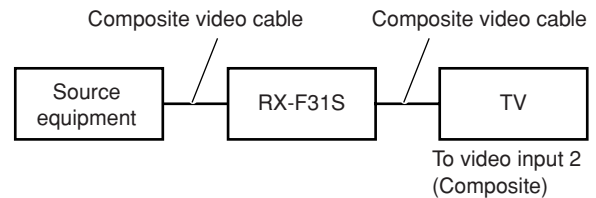

Case 3:

When connecting the source equipment to the receiver through the component video jacks, connect this receiver to the TV's video input 2 terminals (component video input) using component video cables.

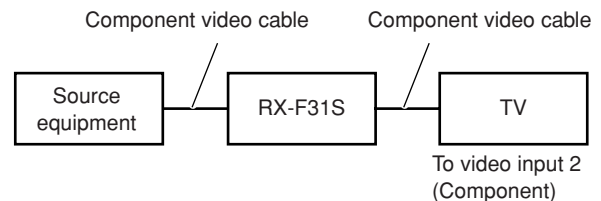

* When using the AV COMPU LINK remote control system, set "DOWN MIX" and "Y/C SEPARATE" to "OFF"; otherwise, this system does not work correctly. For details about each setting, see page 25.

Connecting procedure

- 1 If you have already plugged your VCR, DVD player, TV, and this receiver into the AC outlets, unplug their AC power cords first.**
- 2 Connect your VCR, DVD player, TV, and this receiver as follows, using the cables with the monaural mini-plugs (not supplied).**
 - See "Connections 1" on the previous page.
- 3 Connect the audio input/output jacks on the VCR, DVD player, TV, and this receiver using the audio cables.**
 - See pages 7 to 10.
- 4 Connect the video input/output jacks on the VCR, DVD player, TV, and this receiver using the S-video cables, composite video cables, or component video cables.**
 - See "Connections 2" on the previous page.
- 5 Plug the AC power cords of the connected components and this receiver into the AC outlets.**
- 6 When turning on the TV for the first time after the AV COMPU LINK connection, turn the TV volume to the minimum using the TV volume control on the TV.**
- 7 Turn on other connected components first, then turn on this receiver.**
 - When turning on the VCR, use the remote control supplied with this receiver (press VCR \odot /I).

The AV COMPU LINK remote control system allows you to use the five basic functions listed below.

Remote control of the TV, DVD player, and VCR using this remote control

See pages 42 and 43 for details.

- Aim the remote control directly at **the remote sensor on each component.**

One-touch video play

Simply by inserting a video cassette without its safety tab into the VCR, you can enjoy the video playback without setting other switches manually. The receiver automatically turns on and changes the source to "VCR" (or "VCR DIGITAL").

The TV automatically turns on and changes the input mode to the appropriate position so that you can view the playback picture. When you insert a video cassette with its safety tab, press the play (▶) button on the VCR or on the remote control. So, you can get the same result.

One-touch DVD play

Simply by starting playback on the DVD player, you can enjoy the DVD playback without setting other switches manually.

- When the DVD player is connected through the analog input jacks on this receiver (and analog input is selected), the receiver automatically turns on and changes the source to "DVR/DVD" or "DVD MULTI."
- When the DVD player is connected through the digital input terminal on this receiver (and digital input is selected), the receiver automatically turns on and changes the source to "DVR/DVD DGT."

The TV automatically turns on and changes the input mode to the appropriate position so that you can view the playback picture.

Automatic selection of TV's input mode

- When you select "TV" (or "TV DIGITAL") as the source to play on the receiver, the TV automatically changes the input mode to the TV tuner so that you can watch TV.
- When you select "DVR/DVD" (or "DVR/DVD DGT"), "DVD MULTI," "VCR" (or "VCR DIGITAL"), or "DBS" (or "DBS DIGITAL") as the source to play on the receiver, the TV automatically changes the input mode to the appropriate position (either video input 1 or video input 2) so that you can view the playback picture.

NOTE

This function does not work when you connect this receiver and the TV with the AV COMPU LINK EX terminal using a component video cable. In this case, reconnect the TV referring to Case 1 or Case 2 on page 40.

Automatic power on/off

The TV, DVD player, and VCR turn on and off along with the receiver.

When you turn on the receiver;

- If the previously selected source is "TV" (or "TV DIGITAL") or "DBS" (or "DBS DIGITAL"), only the TV will turn on automatically.
- If the previously selected source is "DVR/DVD" (or "DVR/DVD DGT") or "DVD MULTI," the TV and DVD player will turn on automatically.
- If the previously selected source is "VCR" (or "VCR DIGITAL"), the TV and VCR will turn on automatically.

When you turn off the receiver, the TV, DVD player, and VCR will turn off.

NOTE

If you turn off the receiver while recording on the VCR, the VCR will not turn off, but continue recording.

Operating other JVC products

You can use the supplied remote control to operate not only this receiver but also other JVC products.

- Refer also to the manuals supplied with the other products. Some JVC VCRs can accept two types of the control signals—remote codes “A” and “B.”
 - When operating a VCR whose remote control code is set to “A,” set the manufacturer’s code to “01.”
 - When operating a VCR whose remote control code is set to “B,” set the manufacturer’s code to “02.”
 The initial setting is “01.” For details about the setting, see “Changing the transmittable signals for operating a VCR” on page 45.
- To operate other products, aim the remote control directly at the remote sensor on the target product.

■ TV

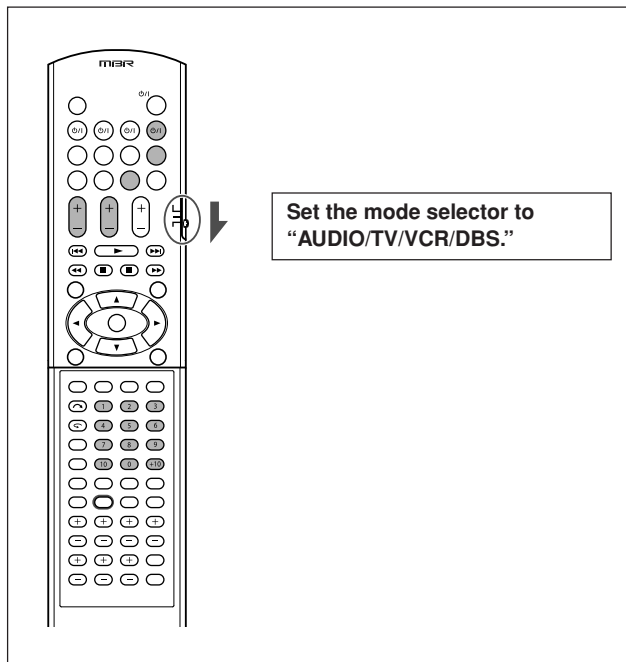

You can always perform the following operations:

TV \odot/I:	Turn on or off the TV.
TV VOL +/-:	Adjust the volume on the TV.
TV/VIDEO:	Change the input mode (either video input or TV tuner) on the TV.

After pressing TV, you can perform the following operations on the TV.

CHANNEL +/-:	Change the channel numbers.
1 – 9, 0, 100+:	Select the channel numbers.
TV RETURN (10):	Function as the TV RETURN button. (Switches between the previous channel and the current channel.)

■ VCR

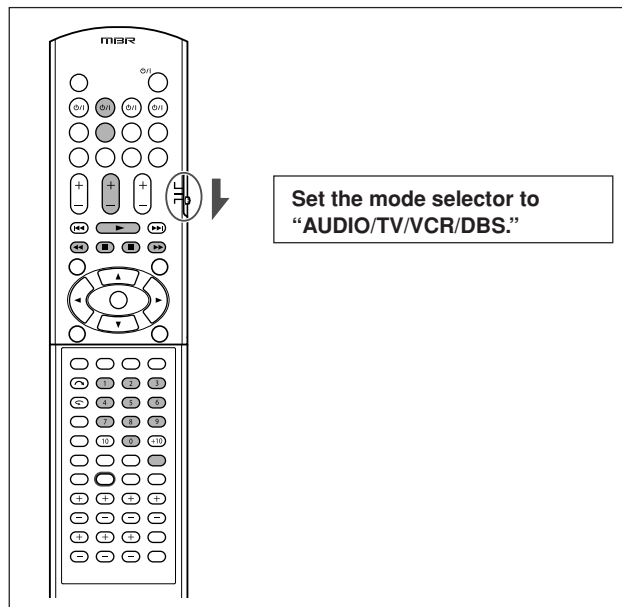

You can always perform the following operation:

VCR \odot/I:	Turn on or off the VCR.
----------------------------------	-------------------------

After pressing VCR, you can perform the following operations on the VCR.

CHANNEL +/-:	Change the channel numbers on the VCR.
1 – 9, 0:	Select the channel numbers on the VCR.
▶:	Start playback.
■:	Stop playback.
 :	Pause playback. To release it, press ▶.
▶▶:	Fast-wind a tape.
◀◀:	Rewind a tape.
REC PAUSE:	Enter recording pause. To start recording, press this button then ▶.

■ DVD recorder or DVD player

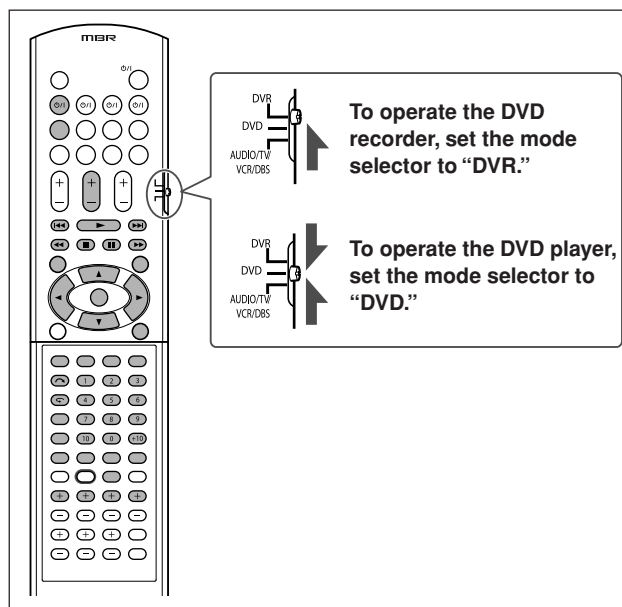

After setting the mode selector correctly, you can perform the following operations on the DVD recorder or DVD player.

See the instructions supplied with the DVD recorder or DVD player for details.

■ Changing the remote control code for DVD recorder

Some JVC DVD recorders can accept four types of the control signals. You can assign one of the four codes to the remote control supplied with this receiver for operating your DVD recorder. For details, refer to the manual supplied with the DVD recorder.

Initial setting: 03

- 1 Set the mode selector to "DVR."
- 2 Press and hold DVR/DVD \odot /I.
- 3 Press DVR/DVD.
- 4 Enter the remote control code you want using buttons 1 – 4, and 0.

EX.: To enter the code "2", press 0, then 2.

Code for DVR	Number to enter
1	01
2	02
3	03
4	04

5 Release DVR/DVD \odot /I.

Now, the remote control code has been changed.

You can always perform the following operation:

DVR/DVD \odot/I:	Turn on or off the DVD recorder or DVD player.
▶:	Start playback.
■:	Stop playback.
II:	Pause playback. To release it, press ▶.
▶▶:	Skip to the beginning of the next chapter.
◀◀:	Return to the beginning of the current (or previous) chapter.
▶▶▶:	Fast-forward playback.
◀◀◀:	Fast-reverse playback.
TOP MENU/MENU:	Display the menu recorded on discs.
ON SCREEN:	Shows the on-screen bar.
▲/▼/▶/◀:	Select an item on the menu screen.
ENTER:	Enter the selected item, channel number, chapter/title number, or track number (if required).

You can also use the following buttons to operate JVC DVD recorder and/or DVD player if it supports the corresponding function:

For various settings:

AUDIO:	Select the audio language/channel.
SUBTITLE:	Select the subtitle language.
SET UP:	Display the Preference display.
VFP:	Show the picture adjustment screen.
PROGRESSIVE*:	Change the scanning mode.
ANGLE:	Select the view angle.

For various playback:

⏮ (one touch replay):

Move the playback position back 10 seconds before the current position.

RETURN:

Return to the main menu during menu operation.

CANCEL:

Cancel the programmed track, etc.

Only for DVD recorder operations:

CHANNEL +/-:	Change the channel numbers.
DVD/HDD:	Select the DVD recorder or HDD deck. (Only for a DVD recorder incorporated with HDD deck.)
⏭ (skip):	Move the playback position ahead 30 seconds after the current position.
1 – 9, 0:	Select a channel number (while stopped) or a chapter/title number, track number (while playing back). Press ENTER to enter the number.
REC MODE:	Select the recording mode.
REC PAUSE:	Enter recording pause. To start recording, press ▶.
DISPLAY:	Change the display information.

Only for DVD player operations:

fs/Rate*:	Show the sampling frequency.
TITLE/GROUP:	Make the numeric buttons work for selecting the title/group number.
ZOOM:	Zoom in and out.
1 – 10, 0, +10:	Select a chapter/title number, track number, menu item, etc.
DVD/CARD:	Select the disc or memory card to play. (Only for a DVD player incorporated with memory card slots.)
DIMMER:	Change the display brightness.
THUMBNAIL:	Show the thumbnail screen for JPEG discs.
SLIDE:	Start the slide show playback for JPEG discs.
3D/S.EFFECT:	Apply the 3D effect.
PAGE:	Show browsable still pictures on DVD Audio discs.

* Press and hold when using these buttons.

If these buttons do not function normally, use the remote control supplied with your DVD recorder or DVD player. Refer also to the manuals supplied with the DVD recorder or DVD player for details.

Operating other manufacturers' products

By changing the transmittable signals, you can use the supplied remote control to operate other manufacturers' products.

- Refer also to the manuals supplied with the other products.
- To operate those components with the remote control, first you need to set the manufacturers' codes each for the TV, VCR, and DBS.
- After replacing batteries of the remote control, set the manufacturers' codes again.

□ Changing the transmittable signals for operating a TV

Set the mode selector to "AUDIO/TV/VCR/DBS."

1 Press and hold TV ϕ/I .

2 Press TV.

3 Enter the manufacturer's code using buttons 1 – 9, and 0.

See "Manufacturers' codes for TV" on the right.

4 Release TV ϕ/I .

Now, you can perform the following operations on the TV.

TV ϕ/I :	Turn on or off the TV.
TV VOL +/-:	Adjust the volume on the TV.
TV/VIDEO:	Change the input mode (either TV or VIDEO).

After pressing TV, you can perform the following operations on the TV.

CHANNEL +/-:	Change the channel numbers.
1 – 9, 0, 100+ (+10):	Select the channel numbers.

See the instructions supplied with the TV for details.

5 Try to operate your TV by pressing TV ϕ/I .

When your TV turns on or off, you have entered the correct code.

If more than one code is listed for your brand of TV, try each one until the correct one is entered.

Manufacturers' codes for TV

Manufacturer	Codes
JVC	01
Akai	02
Bell+Howell	03
Centurion	04
Coronad	05
Daewoo	06, 07, 08
Emerson	09, 10, 11, 12, 13
Fisher	14
GE•Pana	15, 16
GE•RCA	17
Gold Star	18, 19
Hitachi	20, 21
KTV	22, 23
Magnavox	24
Marantz	25
Mitsubishi	25
Panasonic	26, 27
Philips	24
Pioneer	28
Proscan	29
Quasar	30
Radioshack	31
RCA	02, 17, 32, 33, 34, 35
Samsung	36, 37
Sanyo	14
Sears	38
Sharp	39
Sony	40
Symphonic	41, 42
Toshiba	38
Zenith	43, 44

Initial setting: 01

Manufacturers' codes are subject to change without notice. If they are changed, this remote control cannot operate the equipment.

❑ Changing the transmittable signals for operating a VCR

Set the mode selector to "AUDIO/TV/VCR/DBS."

1 Press and hold VCR \odot/I .

2 Press VCR.

3 Enter the manufacturer's code using buttons 1 – 9, and 0.

See "Manufacturers' codes for VCR" on the right.

4 Release VCR \odot/I .

Now, you can perform the following operation on the VCR.

VCR \odot/I :	Turn on or off the VCR.
-------------------------------	-------------------------

After pressing VCR, you can perform the following operations on the VCR.

CHANNEL +/- :	Change the channel numbers on the VCR.
----------------------	--

1 – 9, 0 :	Select the channel numbers on the VCR.
-------------------	--

▶ :	Start playback.
------------	-----------------

■ :	Stop playback.
------------	----------------

⏸ :	Pause playback.
------------	-----------------

▶▶ :	Fast-wind a tape.
-------------	-------------------

◀◀ :	Rewind a tape.
-------------	----------------

See the instructions supplied with the VCR for details.

5 Try to operate your VCR by pressing VCR \odot/I .

When your VCR turns on or off, you have entered the correct code.

If more than one code is listed for your brand of VCR, try each one until the correct one is entered.

Manufacturers' codes for VCR

Manufacturer	Codes
JVC	01, 02, 03, 04
Aiwa	05
Akai	06, 07, 08
Bell+Howell	09
Daewoo	10
Emerson	11, 12, 13, 14, 15
Fisher	16, 17, 18, 19
G.E.	20, 21
Go Video	22
Gold Star	23
Go-Video A	24
Go-Video B	25
Hitachi	20, 26
Magnavox	27, 28, 29
Mitsubishi	30, 31, 32, 33
NEC	34, 35
Panasonic	36, 37
Philips	27
RCA	38
Samsung	39, 40, 41
Sanyo	16, 17, 18, 19
Scott	42
Sharp	43, 44
Shintom	45
Sony	46, 47, 48, 49, 50, 51
Symphonic	52
Teknica	53, 54
Toshiba	55
Zenith	56

Initial setting: 01

<p>Manufacturers' codes are subject to change without notice. If they are changed, this remote control cannot operate the equipment.</p>

❑ Changing the transmittable signals for operating a DBS tuner

Set the mode selector to "AUDIO/TV/VCR/DBS."

- 1 Press and hold DBS \odot/I .
- 2 Press DBS.
- 3 Enter the manufacturer's code using buttons 1 – 9, and 0.

See "Manufacturers' codes for DBS tuner" below.

4 Release DBS \odot/I .

Now, you can perform the following operation on the DBS tuner.

DBS \odot/I:	Turn on or off the DBS tuner.
---	-------------------------------

After pressing DBS, you can perform the following operations on the DBS tuner.

CHANNEL +/-:	Change the channel numbers on the DBS tuner.
1 – 9, 0:	Select the channel numbers on the DBS tuner.

See the instructions supplied with the DBS tuner for details.

5 Try to operate your DBS tuner by pressing DBS \odot/I .

When your DBS tuner turns on or off, you have entered the correct code.

If more than one code is listed for your brand of DBS tuner, try each one until the correct one is entered.

Manufacturers' codes for DBS tuner

Manufacturer	Codes
Echostar	40
G.I.	01, 41
Gemini	02
Hamlin	03, 04, 05, 06
Hitachi	42
Hughes	43
Jerrold	07, 08, 09, 10, 11, 12, 13, 14, 15
Macom	16, 17, 18
Magnavox	19
Oak	20, 21, 22
Panasonic	23, 24, 44
Philips	25, 26, 27, 28, 29, 30
Pioneer	31, 32
Primestar	45
RCA	46
S. Atlanta	33, 34, 35
Samsung	36
Sony	47
Tocom	37
Toshiba	48
Zenith	38, 39

Initial setting: 01

❑ Changing the transmittable signals for operating a DVD player

Set the mode selector to "DVD."

- 1 Press and hold DVR/DVD \odot/I .
- 2 Press DVR/DVD.
- 3 Enter the manufacturer's code using buttons 1 – 9, and 0.

See "Manufacturers' codes for DVD player" below.

4 Release DVR/DVD \odot/I .

Now, you can perform the following operation on the DVD player.

DVR/DVD \odot/I:	Turn on or off the DVD player.
▶:	Start playback.
◀◀:	Return to the beginning of the current chapter (or fast-forward for some models).
▶▶:	Skip to the beginning of the next chapter (or fast-reverse for some models).
■:	Stop playback.
⏸:	Pause playback.
MENU:	Display the menu recorded on DVD VIDEO discs.
▲/▼/▶/◀:	Select an item on the menu screen.
ENTER:	Enter the selected item.
1 – 9, 0:	Select the chapter number.

See the instructions supplied with the DVD player for details.

5 Try to operate your DVD player by pressing DVR/DVD \odot/I .

When your DVD player turns on or off, you have entered the correct code.

If more than one code is listed for your brand of DVD player, try each one until the correct one is entered.

Manufacturers' codes for DVD player

Manufacturer	Codes
JVC	01
Hitachi	12
Kenwood	05, 08
Mitsubishi	10
Onkyo	15, 16
Panasonic	04
Philips	07
Pioneer	03
Samsung	14
Sony	02
Toshiba	06
Yamaha	09

Initial setting: 01

NOTE

You cannot use this remote control to operate other manufacturers' DVD recorder.

Manufacturers' codes are subject to change without notice. If they are changed, this remote control cannot operate the equipment.

Troubleshooting

Use this chart to help you solve daily operational problems. If there are any problems you cannot solve, contact your JVC's service center.

	PROBLEM	POSSIBLE CAUSE	SOLUTION
Power	The power does not come on.	The power cord is not plugged in.	Plug the power cord into an AC outlet.
	The receiver turns off (enters standby mode).	Speakers are overloaded because of high volume.	1. Stop the playback source. 2. Turn on the receiver again, then turn the volume down.
		Speakers are overloaded because of a short circuit at the speaker terminals.	Check the speaker wiring. If speaker wiring is not short-circuited, contact your dealer.
		The receiver is overloaded because of a high voltage.	Consult your dealer after unplugging the power cord.
"OVER HEAT" flashes on the display, then the receiver turns off.	The receiver is overloaded because of high volume or long time usage.	Turn on the receiver again. If the receiver turns off soon, consult your dealer after unplugging the power cord.	
Sound and picture	No sound from speakers.	Speaker signal cables are not connected.	Check speaker wiring, then reconnect if necessary (see page 6) after unplugging the power cord.
		Connections are incorrect.	Check the audio connections (see pages 7 to 11) after unplugging the power cord.
		An incorrect source is selected.	Select the correct source.
		Muting is activated.	Press MUTING to cancel the mute (see page 15).
		An incorrect input mode (analog or digital) is selected.	Select the correct input mode (analog or digital).
	TV Direct is activated.	Deactivate TV Direct (see page 14).	
	Sound from one speaker only.	Speaker signal cables are not connected properly.	Check speaker wiring and reconnect if necessary (see page 6) after unplugging the power cord.
Bass sound is reinforced too much when listening in stereo.	Appropriate bass level is not selected.	Adjust audio position level (see page 14).	
Sounds are intermittently distorted or the noise is heard by the outside noise such as a lightning discharge.	The sounds may be intermittently distorted or the noise may be heard by the outside noise such as a lightning discharge but the sound will be restored automatically.	This is not a malfunction. But if this continues, turn on the receiver again.	
No picture is displayed on the monitor.	Connections are incorrect.	Check the video connections (see pages 7 to 10) after unplugging the power cord.	
	Input mode is incorrect.	Check the component video input mode (see page 25).	
Remote control	Remote control does not operate as you intend.	The remote control is not ready for your intended operation.	Set the mode selector correctly, then press the corresponding source selecting button or SOUND before operation
	Remote control does not work.	There is an obstruction hiding the remote sensor on the receiver.	Remove the obstruction.
		Batteries are weak.	Replace batteries.
		The mode selector is set to the incorrect position.	Set the mode selector to the proper position.
Buttons cannot be used.	TV Direct is activated.	Deactivate TV Direct (see page 14).	
Tuner	Continuous hiss or buzzing during FM reception.	Incoming signal is too weak.	Connect an outdoor FM antenna or contact your dealer.
		The station is too far away.	Select another station.
		The wrong antenna is being used.	Check with your dealer to be sure you have the correct antenna.
		Antennas are not connected properly.	Check the connections.
	Occasional cracking noise during FM reception.	Ignition noise from automobiles.	Move the antenna farther from automobile traffic.

Specifications

Designs and specifications are subject to change without notice.

Amplifier

Output Power

At stereo operation:

Front channels: 100 W* per channel, min. RMS, driven into 6 Ω at 1 kHz with no more than 10% total harmonic distortion.

At surround operation:

Front channels: 100 W* per channel, min. RMS, driven into 6 Ω at 1 kHz with no more than 0.8% total harmonic distortion.

Center channel: 100 W*, min. RMS, driven into 6 Ω at 1 kHz, with no more than 0.8% total harmonic distortion.

Surround channels: 100 W* per channel, min. RMS, driven into 6 Ω at 1 kHz, with no more than 0.8% total harmonic distortion.

Surround back channel: 100 W*, min. RMS, driven into 6 Ω at 1 kHz, with no more than 0.8% total harmonic distortion.

* Measured on AC 110 V, 127 V, 220 V, and 240 V.

Audio

Audio Input Sensitivity/Impedance:

DVR/DVD (DVD MULTI), VCR, DBS, TV:
330 mV/47 k Ω

Audio Input (DIGITAL IN)*:

Coaxial: DIGITAL IN 1(DVR/DVD):
0.5 V(p-p)/75 Ω

Optical: DIGITAL IN 2(DBS), 3(VCR):
-21 dBm to -15 dBm
(660 nm \pm 30 nm)

* Corresponding to Linear PCM, Dolby Digital, and DTS (with sampling frequency—32 kHz, 44.1 kHz, 48 kHz).

Audio Output Level:

DVR, VCR, MONITOR OUT: 330 mV

Signal-to-Noise Ratio (*66 IHF/DIN): 80 dB/62 dB

Frequency Response (8 Ω): 20 Hz to 20 kHz (\pm 1 dB)

Bass Boost: +4 dB \pm 1 dB at 100 Hz

Equalization (at DSP operation):

Center frequency: 63 Hz, 250 Hz, 1 kHz, 4 kHz, 16 kHz
Control range: \pm 8 dB

Video

Video Input Sensitivity/Impedance:

Composite video: DVR/DVD, VCR, DBS:
1 V(p-p)/75 Ω

S-video: DVR/DVD, VCR, DBS:

Y (luminance): 1 V(p-p)/75 Ω

C (chrominance, burst): 0.3 V(p-p)/75 Ω

Component: DVR/DVD, VCR:

Y (luminance): 1 V(p-p)/75 Ω

PB, PR: 0.7 V(p-p)/75 Ω

Video Output Level/Impedance:

Composite video: DVR, VCR, MONITOR OUT:
1 V(p-p)/75 Ω

S-video: DVR, VCR, MONITOR OUT:

Y (luminance): 1 V(p-p)/75 Ω

C (chrominance, burst): 0.3 V(p-p)/75 Ω

Component: MONITOR OUT:

Y (luminance): 1 V(p-p)/75 Ω

PB, PR: 0.7 V(p-p)/75 Ω

Synchronization: Negative

FM tuner (IHF)

Tuning Range: 87.50 MHz to 108.00 MHz

Usable Sensitivity:

Monaural: 12.8 dBf (1.2 μ V/75 Ω)

50 dB Quieting Sensitivity:

Monaural: 16.0 dBf (1.7 μ V/75 Ω)

Stereo: 37.5 dBf (20.5 μ V/75 Ω)

Stereo Separation at OUT(REC): 35 dB at 1 kHz

AM tuner

Tuning Range: 531 kHz to 1 710 kHz

General

Power Requirements: AC 110 V/127 V/220 V/230 V – 240 V \sim , adjustable with the voltage selector, 50 Hz/60 Hz

Power Consumption: 120 W (at operation)

5 W (in standby mode)

Dimensions (W x H x D): 435 mm x 70 mm x 317.2 mm

Mass: 6.3 kg

Mains (AC) Line Instruction (not applicable for Europe, U.S.A., Canada, and U.K.)

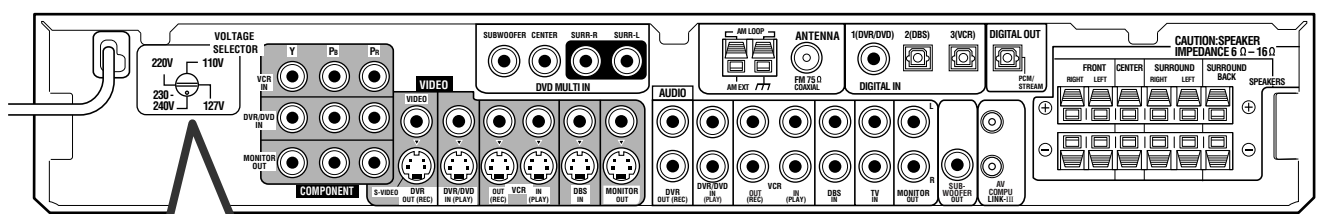

VOLTAGE SELECTOR

CAUTION for mains (AC) line

BEFORE PLUGGING IN, do check that your mains (AC) line voltage corresponds with the position of the voltage selector switch provided on the outside of this equipment and, if different, reset the voltage selector switch, to prevent from a damage or risk of fire/electric shock.

